

# VDSL 4 Band Solution CPE (NT)

APC77151

## FEATURES

- Compact four band packet over VDSL (4bPoVDSL)
- Minimum footprint design for maximized port density
- Optimized for use with Infineon 22810, 22815 and 22834 chipsets
- Plan 998 specification



## BLOCK DIAGRAM

APC77151

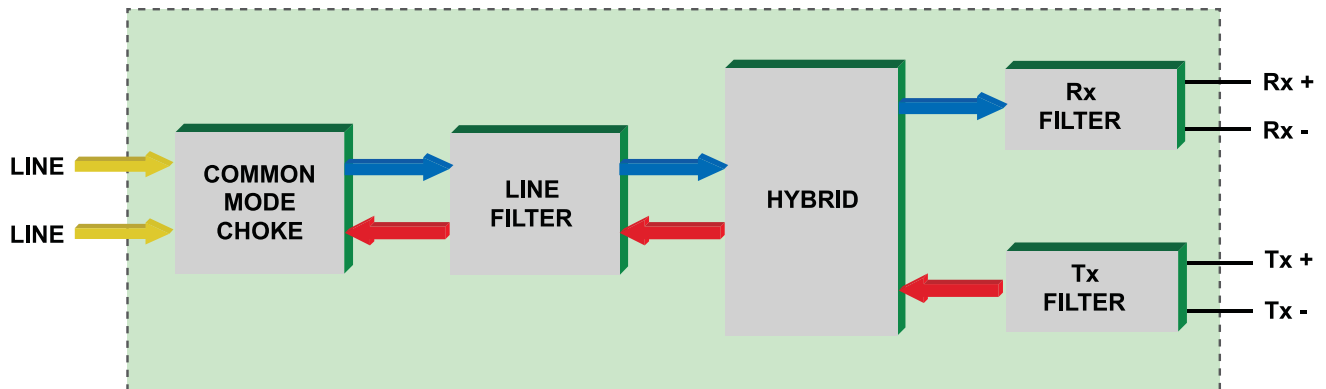

### BAND ALLOCATION

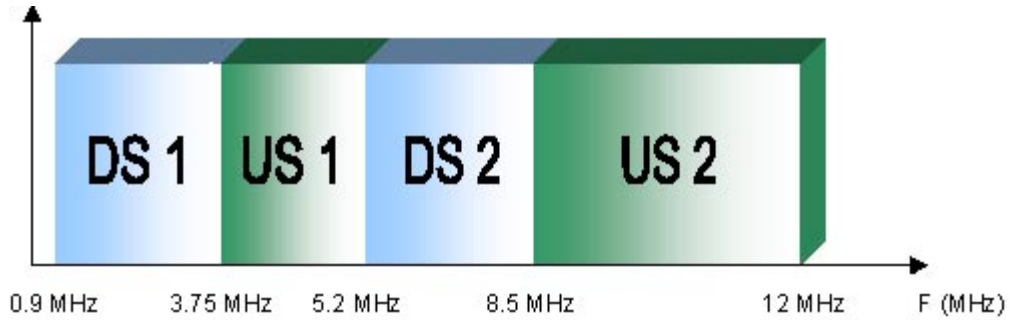

### FREQUENCY RESPONSE

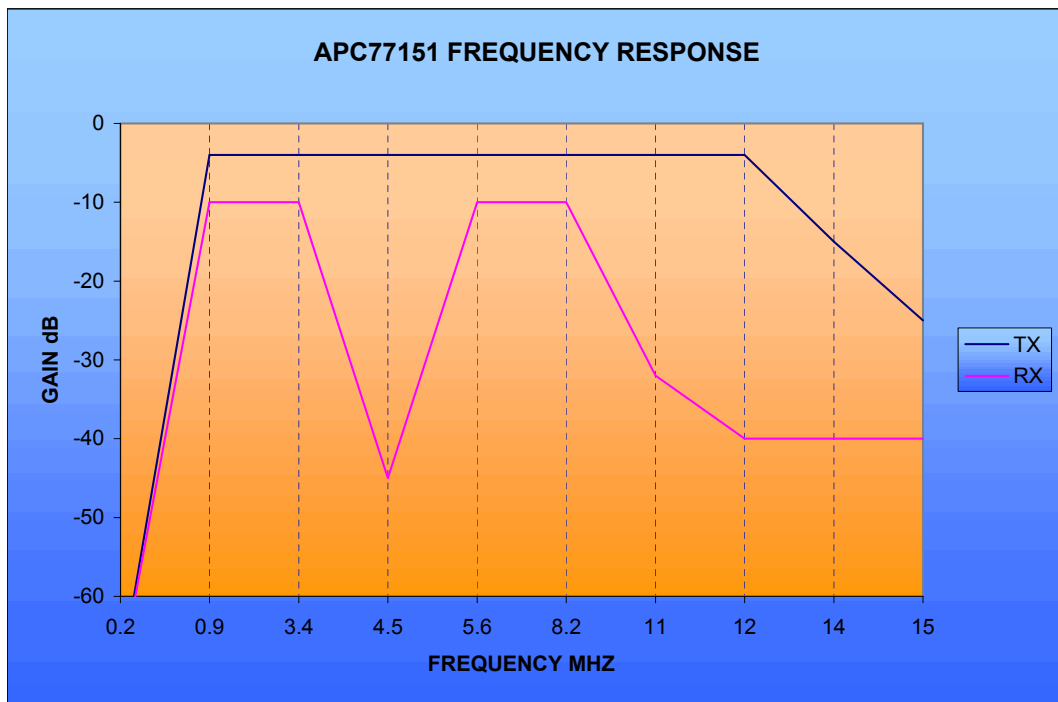

# VDSL 4 Band Solution CPE (NT)

## APC77151

### MECHANICAL

#### APC77151

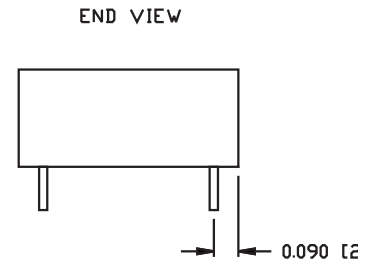
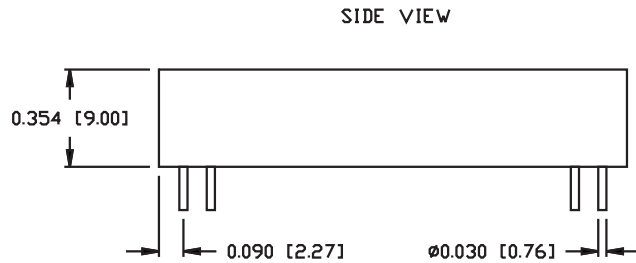
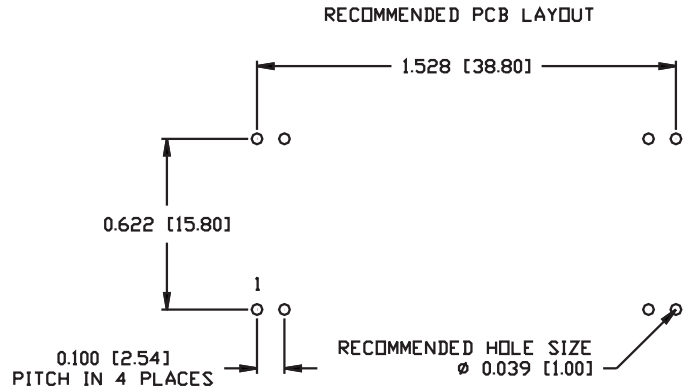
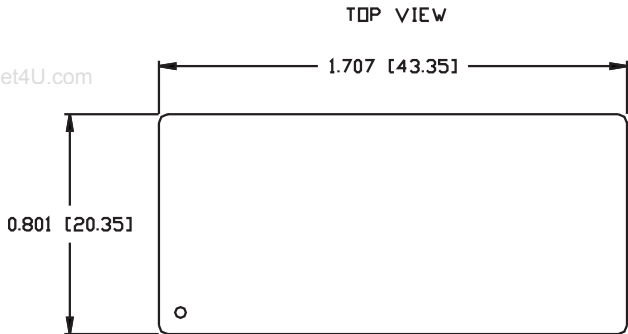

Pin Number	Signal Name
1	Line+
2	Line-
3	TX+
4	TX-
5	RX+
6	RX-
7 & 8	N/C

©2004 Bel Fuse Inc. Specifications subject to change without notice. 11.03.04

#### CORPORATE

Bel Fuse Inc.  
206 Van Vorst Street  
Jersey City, NJ 07302  
Tel 201-432-0463  
Fax 201-432-9542  
www.belfuse.com

#### FAR EAST

Bel Fuse Ltd.  
8F / 8 Luk Hop Street  
San Po Kong  
Kowloon, Hong Kong  
Tel 852-2328-5515  
Fax 852-2352-3706  
www.belfuse.com

#### EUROPE

Bel Stewart Connector  
45/46 Riverside  
Medway City Estate  
Rochester, Kent ME2 4DP U.K.  
Tel 44-1634-722890  
Fax 44-1634-716677  
www.belfuse.com