

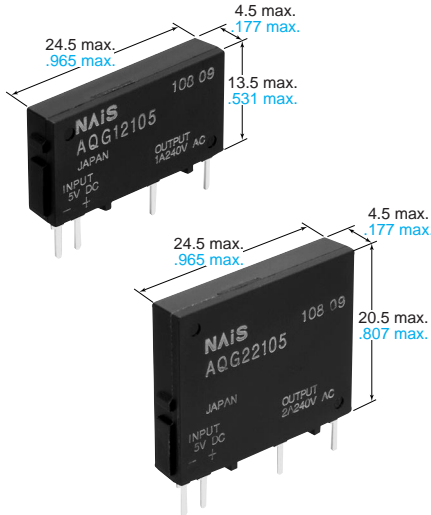

# AQ-G RELAYS



mm inch

## FEATURES

- Space saving, Slim size with a maximum thickness of 4.5 mm.**  
Mounting space has been reduced to 30% (compared to conventional SSR's) while meeting high density PC board mounting requirements.
- 1A and 2A load types available**
- Zero-cross type and Non zero-cross type available**

- High dielectric strength of 3,000V AC** (between input and output)
- Snubber circuit integrated**  
The snubber circuit is integrated to prevent malfunction caused by the rapid rise of voltage on the output side, such as inductive load and current.

## TYPES

Type	Load current	Load voltage	Input voltage	Part No.
Zero-cross	1A	75 to 264 V AC	5 V DC	AQG12105
			12 V DC	AQG12112
			24 V DC	AQG12124
	2A	75 to 264 V AC	5 V DC	AQG22105
			12 V DC	AQG22112
			24 V DC	AQG22124
Non zero-cross	1A	75 to 264 V AC	5 V DC	AQG12205
			12 V DC	AQG12212
			24 V DC	AQG12224
	2A	75 to 264 V AC	5 V DC	AQG22205
			12 V DC	AQG22212
			24 V DC	AQG22224

## TYPICAL APPLICATIONS

- Manufacturing equipment**
  - NC machines
  - Injection molders
  - Robots
- Air conditioners**
- Computers**

## ORDERING INFORMATION

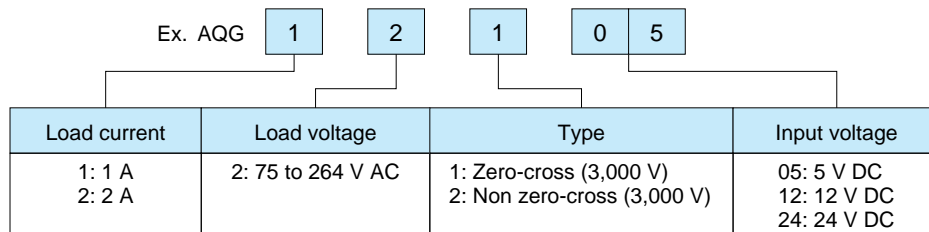

(Note) Standard packing: Carton 20 pcs., Case 500 pcs.

## SPECIFICATIONS

1. Ratings (at 20°C 68°F, Input voltage ripple: 1% or less)

1) Zero-cross type

Item	Type	Part No.						Remarks
		AQG12105	AQG12112	AQG12124	AQG22105	AQG22112	AQG22124	
Input side	Input voltage	4 to 6 V DC	9.6 to 14.4 V DC	19.2 to 28.8 V DC	4 to 6 V DC	9.6 to 14.4 V DC	19.2 to 28.8 V DC	
	Input impedance	Approx. 0.3k Ω	Approx. 0.8k Ω	Approx. 1.6k Ω	Approx. 0.3k Ω	Approx. 0.8k Ω	Approx. 1.6k Ω	
	Drop-out voltage, min.	1 V						
	Reverse voltage	3 V						
Load side	Max. load current	1 A AC			2 A AC			
	Load voltage	75 to 264V AC						
	Frequency	45 to 65 Hz						
	Non-repetitive surge current	8 A			30 A			In one cycle at 60 Hz
	Max. "OFF-state" leakage current	1.5 mA (applied 200 V)						
	Max. "ON-state" voltage drop	1.6 V						at Max. carrying current
	Min. load current	20 mA						

2) Non zero-cross type

Item	Type	Part No.						Remarks
		AQG12205	AQG12212	AQG12224	AQG22205	AQG22212	AQG22224	
Input side	Input voltage	4 to 6 V DC	9.6 to 14.4 V DC	19.2 to 28.8 V DC	4 to 6 V DC	9.6 to 14.4 V DC	19.2 to 28.8 V DC	
	Input impedance	Approx. 0.3k Ω	Approx. 0.8k Ω	Approx. 1.6k Ω	Approx. 0.3k Ω	Approx. 0.8k Ω	Approx. 1.6k Ω	
	Drop-out voltage, min.	1 V						
	Reverse voltage	3 V						
Load side	Max. load current	1 A AC			2 A AC			
	Load voltage	75 to 264V AC						
	Frequency	45 to 65 Hz						
	Non-repetitive surge current	8 A			30 A			In one cycle at 60 Hz
	Max. "OFF-state" leakage current	1.5 mA (applied 200 V)						
	Max. "ON-state" voltage drop	1.6 V						at Max. carrying current
	Min. load current	20 mA						

2. Characteristics (at 20°C 68°F, Input voltage ripple: 1% or less)

Item	Zero-cross type	Non zero-cross type	Remarks
Operate time max.	(1/2 cycle of voltage sine wave) + 1 ms	1 ms	
Release time, max.	(1/2 cycle of voltage sine wave) + 1 ms		
Insulation resistance, min.	10 <sup>9</sup> Ω between input and output		Using 500 V DC megger
Breakdown voltage	3,000 Vrms between input and output		Initial for 1 min.
Vibration resistance	10 to 55 Hz double amplitude of 0.75 mm		X, Y, Z axes
Shock resistance	1,000 m/s <sup>2</sup>		X, Y, Z axes
Ambient temperature	-30°C to +80°C -22°F to +176°F		Non-condensing at low temperatures
Storage temperature	-30°C to +100°C -22°F to +212°F		
Operational method	Zero-cross (Turn-ON and Turn-OFF)	Random turn ON, zero-cross turn OFF	

**DIMENSIONS**

**1. 1A type**

www.DataSheet4U.com

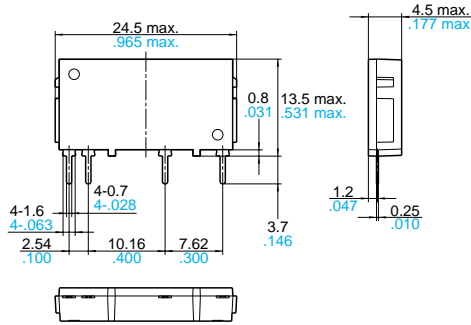

General tolerance:  $\pm 0.2 \pm .008$

PC board pattern (Bottom view)

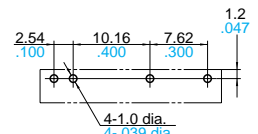

Tolerance:  $\pm 0.1 \pm .004$

Schematic AC type

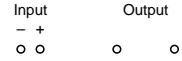

**2. 2A type**

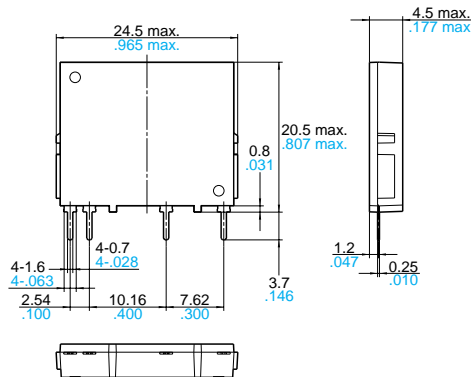

General tolerance:  $\pm 0.2 \pm .008$

PC board pattern (Bottom view)

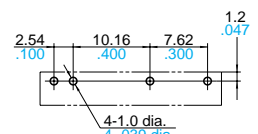

Tolerance:  $\pm 0.1 \pm .004$

Schematic AC type

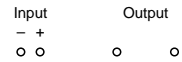

**REFERENCE DATA**

1. Load current vs. ambient temperature

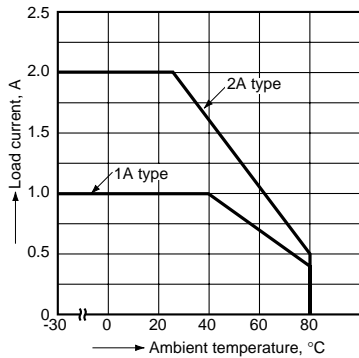

2.-(1) Non-repetitive surge current vs. carrying time (1A type)

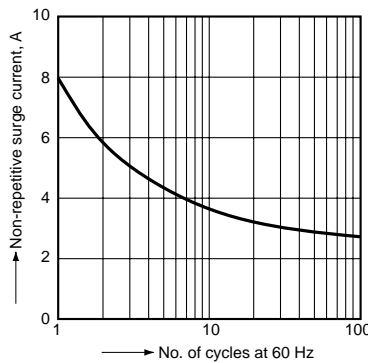

2.-(2) Non-repetitive surge current vs. carrying time (2A type)

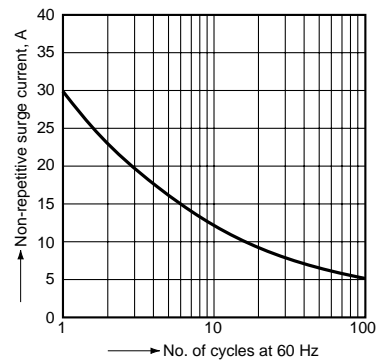

3. Input voltage vs. input current characteristics

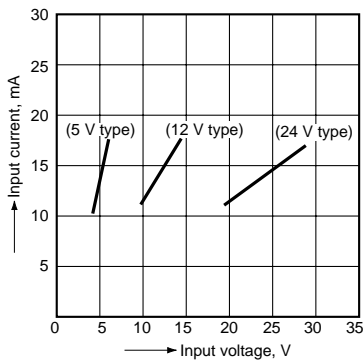

4.-(1) Load current vs. ambient temperature characteristics for adjacent mounting (1A type)

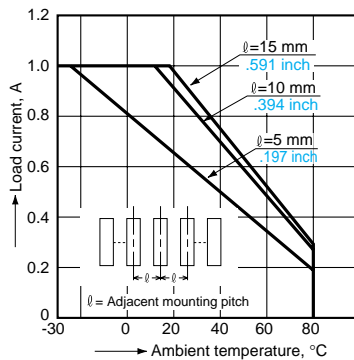

4.-(2) Load current vs. ambient temperature characteristics for adjacent mounting (2A type)

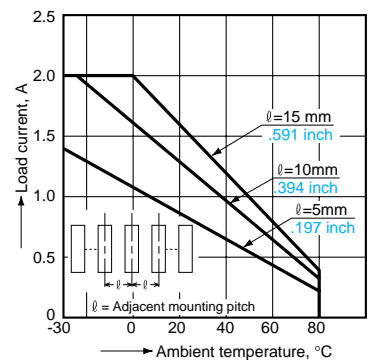

## CAUTIONS FOR USE

### 1. Regarding output noise surge protection [www.DataSheet4U.com](http://www.DataSheet4U.com)

A high noise surge voltage applied to the SSR load circuit can cause malfunction or permanent damage to the device. If such a high surge is anticipated, use a varistor across the SSR output.

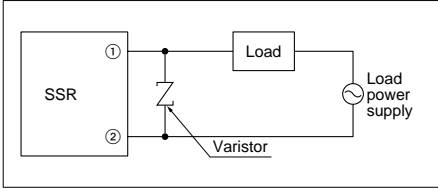

### 2. When used for the load less than rated

An SSR may malfunction if it is used below the specified load. In such an event, use a dummy resistor in parallel with the load.

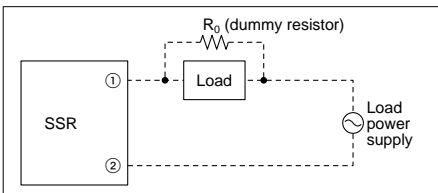

Load specification: Load current 20 mA

### 3. Noise and surge protection at the input side

A high noise surge voltage applied to the SSR input circuit can cause malfunction or permanent damage to the device. If such a high surge is anticipated, use C or R noise absorber in the input circuit.

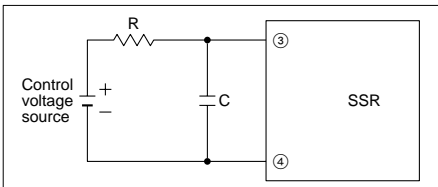

### 4. When the input terminals are connected with reverse polarity

Reversing the polarity may cause permanent damage to the device. Take special care to avoid polarity reversal or use a protection diode in the input circuit.

### 5. In the case of operating voltage containing ripple

If the SSR control voltage contains ripple, the peak of the ripple should not exceed the maximum rated control voltage. The bottom of the ripple should exceed the minimum rated control voltage.

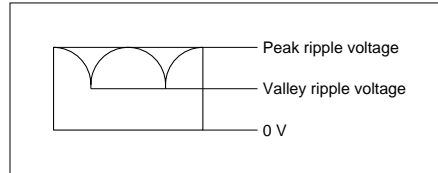

### 6. Cleaning solvents compatibility

Dip cleaning with an organic solvent is recommended for removal of solder flux, dust, etc. Select a cleaning solvent from the following table. If ultrasonic cleaning must be used, the severity of factors such as frequency, output power and cleaning solvent selected may cause loose wires and other defects. Make sure these conditions are correct before use. For details, please consult us.

Cleaning solvent		Compatibility ○: Yes ×: No
Chlorine-base	• Trichlene • Chloroethylene	○
Aqueous	• Indusco • Hollis • Lonco Terg	○
Alcohol-base	• IPA • Ethanol	○
Others	• Thinner • Gasoline	×

### 7. Others

(1) If an SSR is used in close proximity to another SSR or heat-generating device, its ambient temperature may exceed the allowable level. Carefully plan SSR layout and ventilation.

(2) Soldering to SSR terminals should be completed within 5 seconds at 260°C.

(3) Terminal connections should be made by referring to the associated wiring diagram.

(4) For higher reliability, check device quality under actual operating conditions.

### 8. Thermal Design

SSRs used in high-reliability equipment require careful thermal design. In particular, junction temperature control has a significant effect on device function and life time. The rated load current for board-mounting SSRs is defined as the maximum current possible at an ambient temperature of 40°C (30°C) while allowing natural cooling (self cooling). If the ambient temperature exceeds 40°C (30°C), load current derating is necessary according to the load current versus ambient temperature curve. If adjacent devices act as heat sources, the SSR should be located more than 10 mm away from those devices.