

Voltage Variable Absorptive Attenuator, 35 dB

0.5 - 2 GHz

AT-109

V 2.00

Features

- Single Positive Voltage Control 0 to +5 Volts
- 35 dB Attenuation Range at 0.9 GHz
- ± 2 dB Linearity from BSL
- Low DC Power Consumption
- Temperature Range: -40°C to $+85^{\circ}\text{C}$
- Low-Cost SOIC 8 Plastic Package
- Tape and Reel Packaging Available

Description

M/A-COM's AT-109 is a GaAs MMIC voltage variable absorptive attenuator in a low-cost SOIC 8-lead surface mount plastic package. The AT-109 is more linear than the higher attenuation range AT-108. The AT-109 is ideally suited for use where linear attenuation fine tuning and very low power consumption are required. Typical applications include radio, cellular, GPS equipment and automatic gain/level control circuits.

The AT-109 is fabricated with a monolithic GaAs MMIC using a mature 1-micron process. The process features full chip passivation for increased performance and reliability.

SO-8

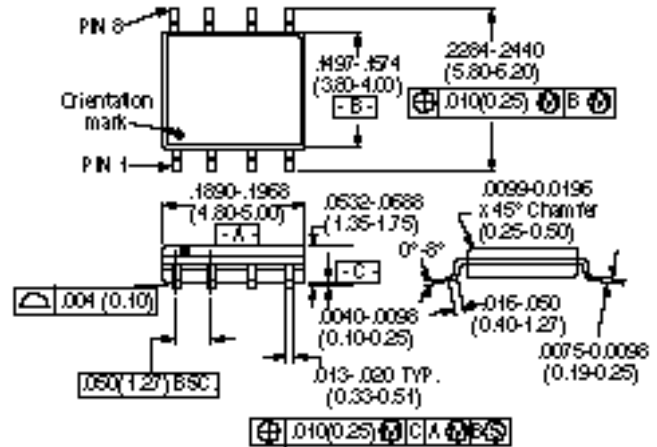

8-Lead SOP outline dimensions
Narrow body .150
(All dimensions per JEDEC No. MS-012-AA, Issue C)
Dimensions in () are in mm.
Unless Otherwise Noted: xxx = ± 0.010 (xxx = ± 0.25)
xx = ± 0.02 (x = ± 0.5)

Ordering Information

Part No.	Package
AT-109	SOIC 8-Lead Plastic Package
AT-109TR	Forward Tape & Reel*
AT-109RTR	Reverse Tape & Reel*

* If specific reel size is required, consult factory for part number assignment.

Electrical Specifications¹, $T_A = +25^{\circ}\text{C}$

Parameter	Test Conditions ¹	Unit	Min.	Typ.	Max
Insertion Loss	0.5 - 1.0 GHz	dB		2.5	2.7
	1.0 - 2.0 GHz	dB		3.2	3.5
Attenuation	0.5 - 1.0 GHz	dB	35		
	1.0 - 2.0 GHz	dB	30		
Flatness (Peak-to-Peak)	0.5 - 1.0 GHz	dB		± 0.5	± 0.8
	1.0 - 2.0 GHz	dB		± 1.2	± 1.5
VSWR				2:1	
Trise, Tfall	10% to 90% RF, 90% to 10% RF	μS		25	
Ton, Toff	50% Control to 90% RF, Control to 10% RF	μS		35	
Transients	In-band	mV		12	

1. All measurements at 1 GHz in a 50- Ω system, unless otherwise specified. The RF ports must be blocked outside of the package from ground or any other voltage.

Absolute Maximum Ratings¹

Parameter	Absolute Maximum
Maximum Input Power	+21 dBm
Supply Voltage V_{CC}	-1 V, +8 V
Control Voltage V_C	-1 V, $V_{CC} + 0.5$ V
Operating Temperature	-40°C to +85°C
Storage Temperature	-65°C to +150°C

1. Operation of this device above any one of these parameters may cause permanent damage.

Functional Schematic

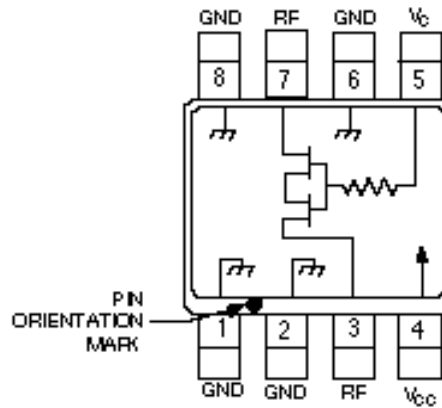

$V_{CC} = +5$ VDC ± 0.5 VDC @ 50 μ A max.
 $V_C = 0$ VDC to +5 VDC @ 50 μ A max.
 External DC blocking capacitors are required on all RF ports.

Typical Performance

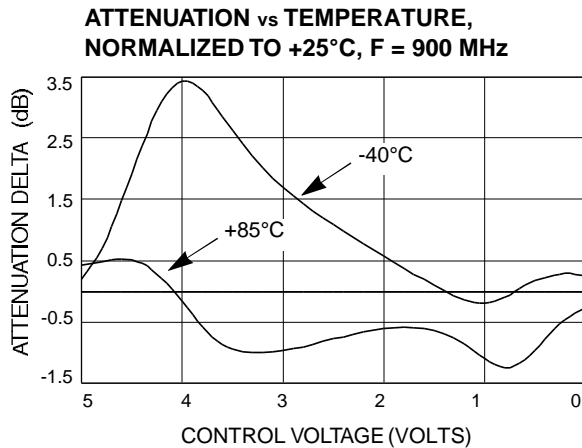
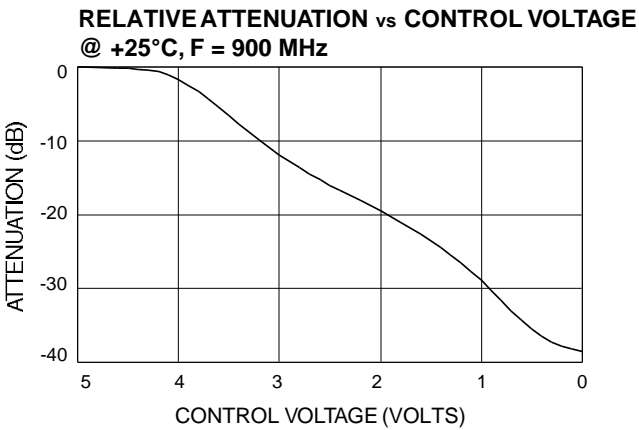
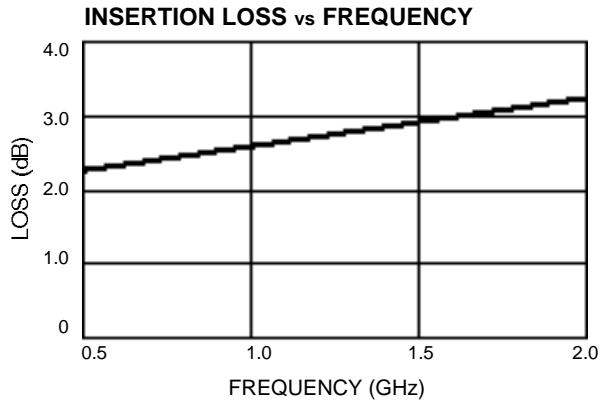
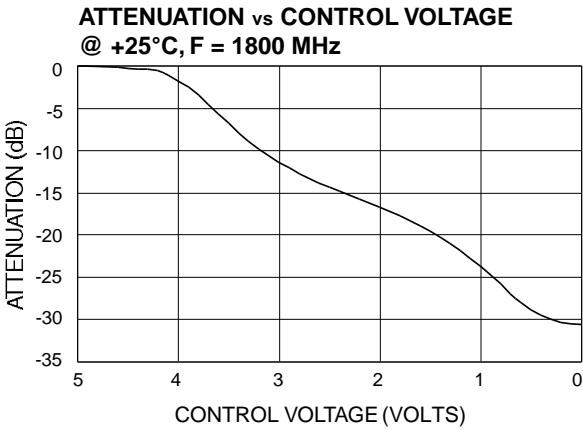

RETURN LOSS vs CONTROL VOLTAGE
 @ +25°C, F = 900 MHz

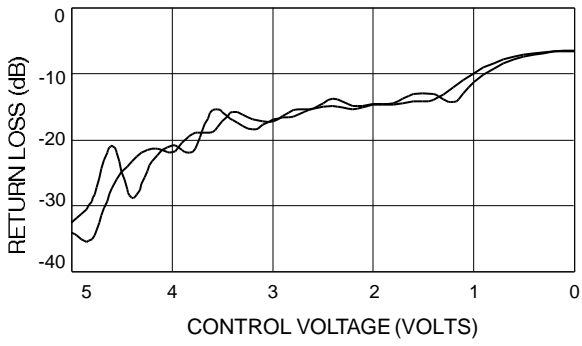

1 dB COMPRESSION vs CONTROL VOLTAGE
 @ +25°C, F = 900 MHz

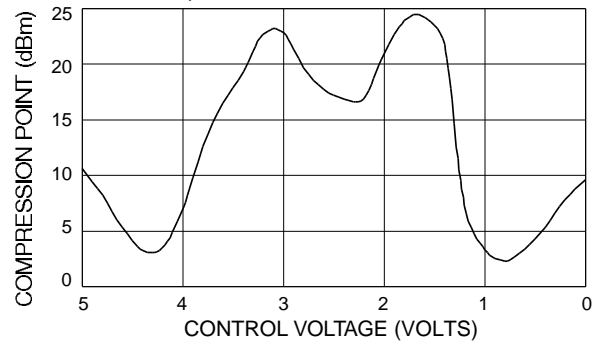

IP₃ vs CONTROL VOLTAGE

