

21-26.5GHz Down converter *Preliminary*

www.datasheet4u.com

GaAs Monolithic Microwave IC in SMD package

Description

The CHR3693-QDG is a multifunction part, which integrates a balanced cold FET mixer, a time two multiplier, and a RF LNA. It is designed for a wide range of applications, typically commercial communication systems.

The circuit is manufactured with a PM-HEMT process, 0.25µm gate length, via holes through the substrate and air bridges.

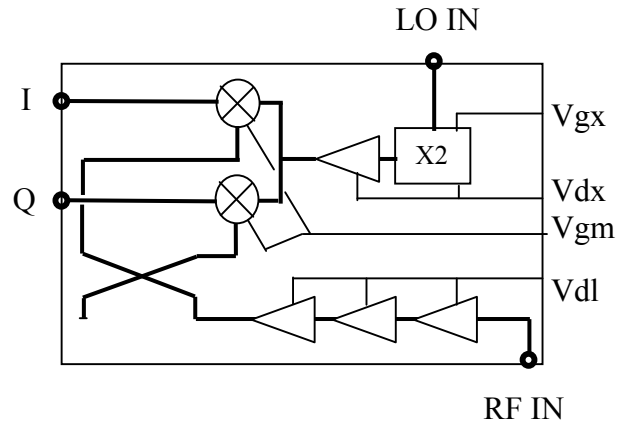

It is supplied in lead-free SMD package.

Main Features

- Broadband performance 21-26.5GHz
- 14dB gain
- -5dBm IIP3
- 18dBc Image rejection
- 24LQFN4x4

Conversion gain (Inf. & Sup. Mode)

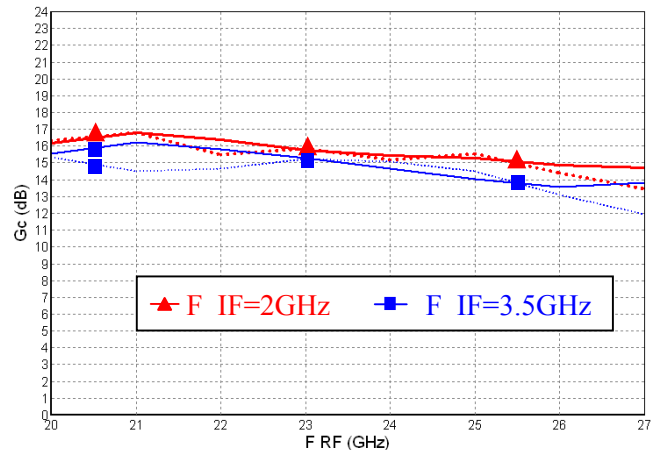

Main Characteristics

T_{amb.} = 25°C, V_d = 4V

Symbol	Parameter	Min	Typ	Max	Unit
F _{RF}	RF frequency range	21		26.5	GHz
F _{LO}	LO frequency range	9		14	GHz
F _{IF}	IF frequency range	DC		3.5	GHz
G _c	Conversion gain		14		dB

ESD Protection: Electrostatic discharge sensitive device. Observe handling precautions!

Electrical Characteristics

Tamb=25°C, Vdx=Vdl = 4V, Typical Vgx = -0.9V & Vgm= -0.7V

These values are representative of onboard measurements (on connector access planes) as defined on the drawing 96401

Preliminary

www.datasheet4u.com

Symbol	Parameter	Min	Typ	Max	Unit
F _{RF}	RF frequency range	21		26.5	GHz
F _{LO}	LO frequency range	9		14	GHz
F _{IF}	IF frequency range	DC		3.5	GHz
G _c	Conversion gain		14		dB
NF	Noise Figure		3		dB
P _{LO}	LO Input power		2		dBm
Img Sup	Image Suppression (1)		18		dBc
IIP3	Input IP3		-5		dBm
LO VSWR	Input LO VSWR		2.0:1		
RF VSWR	Input RF VSWR (21 to 23.6GHz) Input RF VSWR (24.5 to 26.5GHz)		1.7:1 2.3:1		
LO/RF	Isolation LO → RF		45		dBc
2LO/RF	Isolation 2LO → RF		35		dBc
I _d	Bias current (2)		160		mA

(1) With external I/Q 90° hybrid coupler

(2) Typically, I_{dl}= 90mA, I_{dx}=70mA

Absolute Maximum Ratings (1)

Tamb = +25°C

Symbol	Parameter	Values	Unit
V _d	Maximum drain bias voltage	4.5	V
I _d	Maximum drain bias current	230	mA
V _g	Gate bias voltage	-2.0 to +0.4	V
P _{RF}	Maximum RF input power	10	dBm
P _{LO}	Maximum LO input power	10	dBm
T _{ch}	Maximum channel temperature (2)	175	°C
T _a	Operating temperature range	-40 to +85	°C
T _{stg}	Storage temperature range	-55 to +125	°C

(1) Operation of this device above anyone of these paramaters may cause permanent damage.

(2) Thermal Resistance channel to ground paddle = 63.6°C/W for Tamb. = +85°C

Typical Measured Performance

Preliminary

Tamb. = 25°C, Vdx=Vdl = 4V, Typical Vgx = -0.9V & Vgm= -0.7V

These values are representative of onboard measurements as defined on the drawing 96401 (on connector access planes)

www.datasheet4u.com

Conversion Gain (infradyne mode) @ Freq_IF=2GHz, P_LO=2dBm

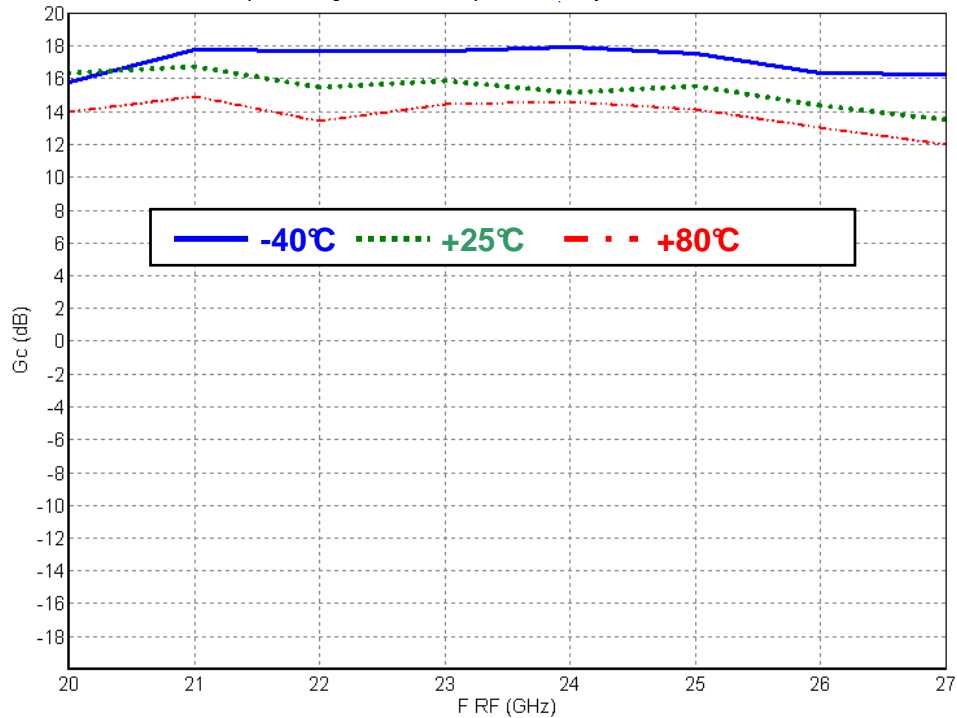

Conversion Gain (supradyne mode) @ Freq_IF=2GHz, P_LO=2dBm

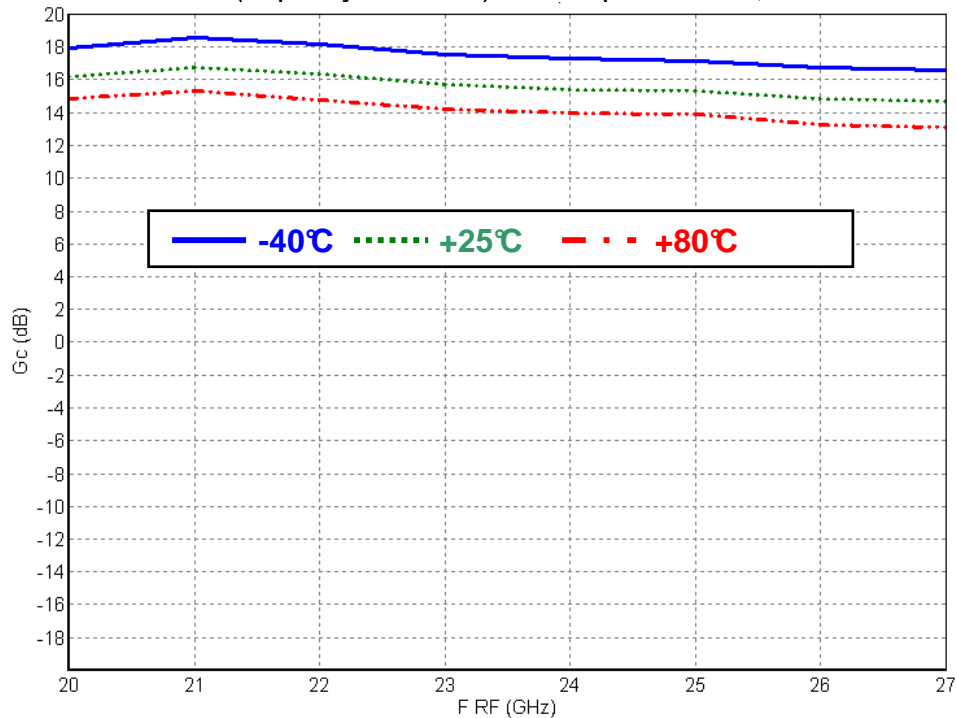

Preliminary

Image Frequency rejection (inf. & sup. Mode) @ -40, +25, +80°C

www.datasheet4u.com

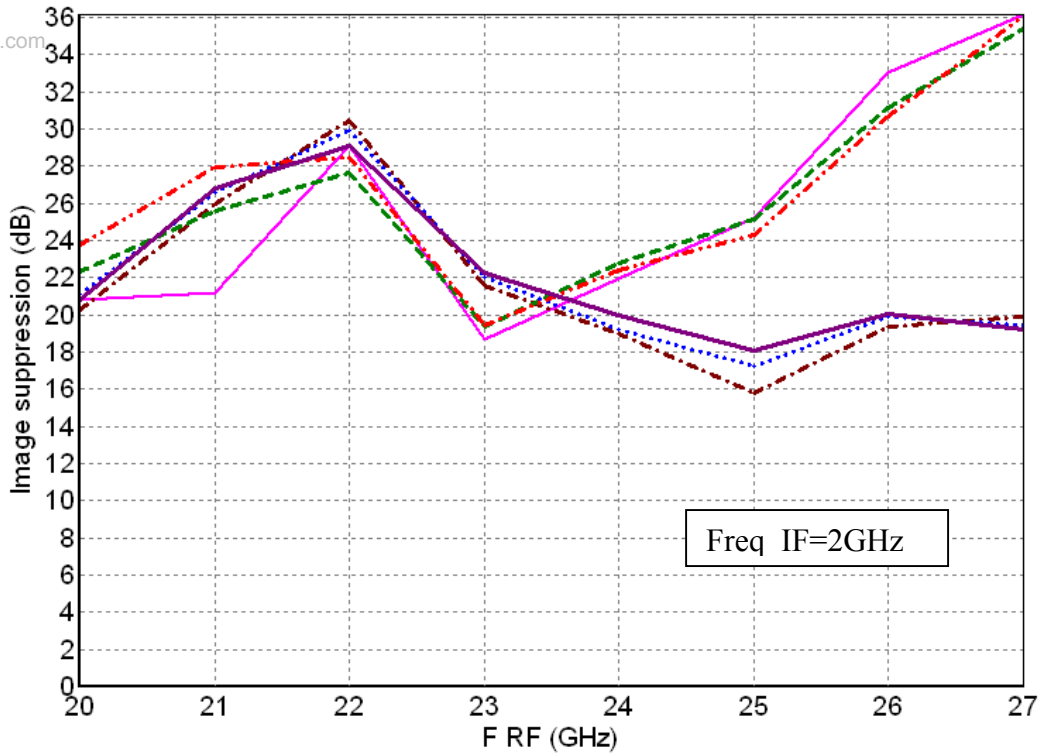

Noise figure channel I & Q @ -40, +25, +80°C

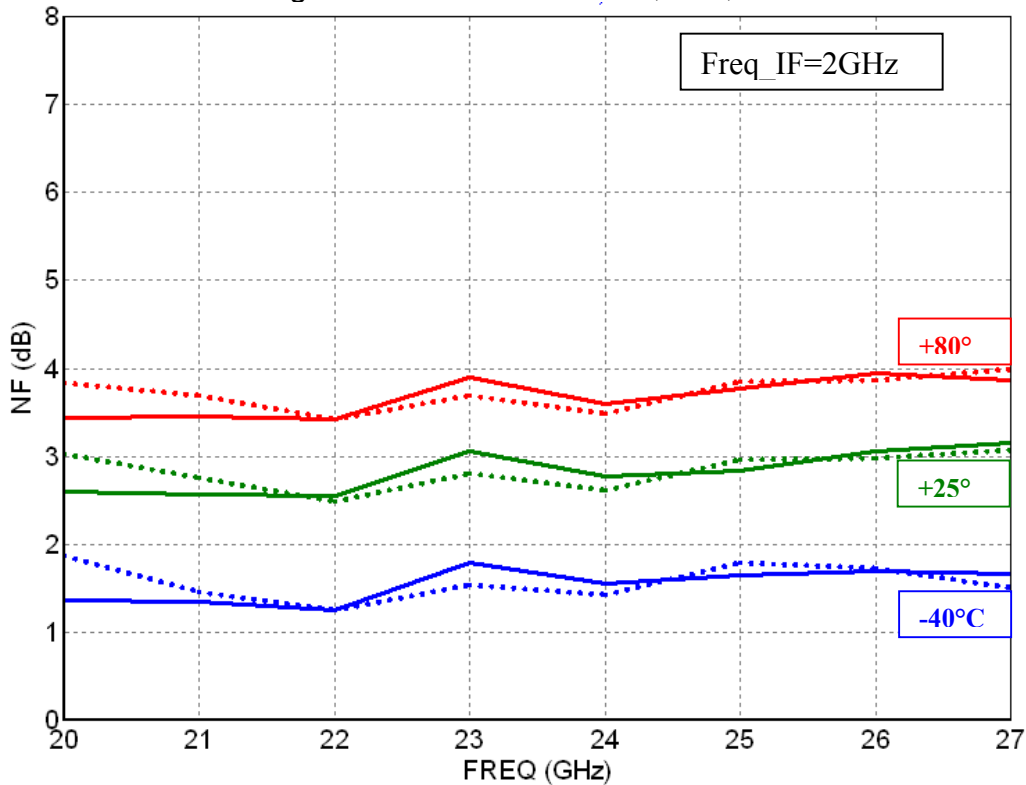

Preliminary

Compression vs P_{RF} (inf. & sup. Mode) @ F_{RF}=21GHz & F_{IF}=3GHz
P_{LO}=2dBm

www.datasheet4u.com

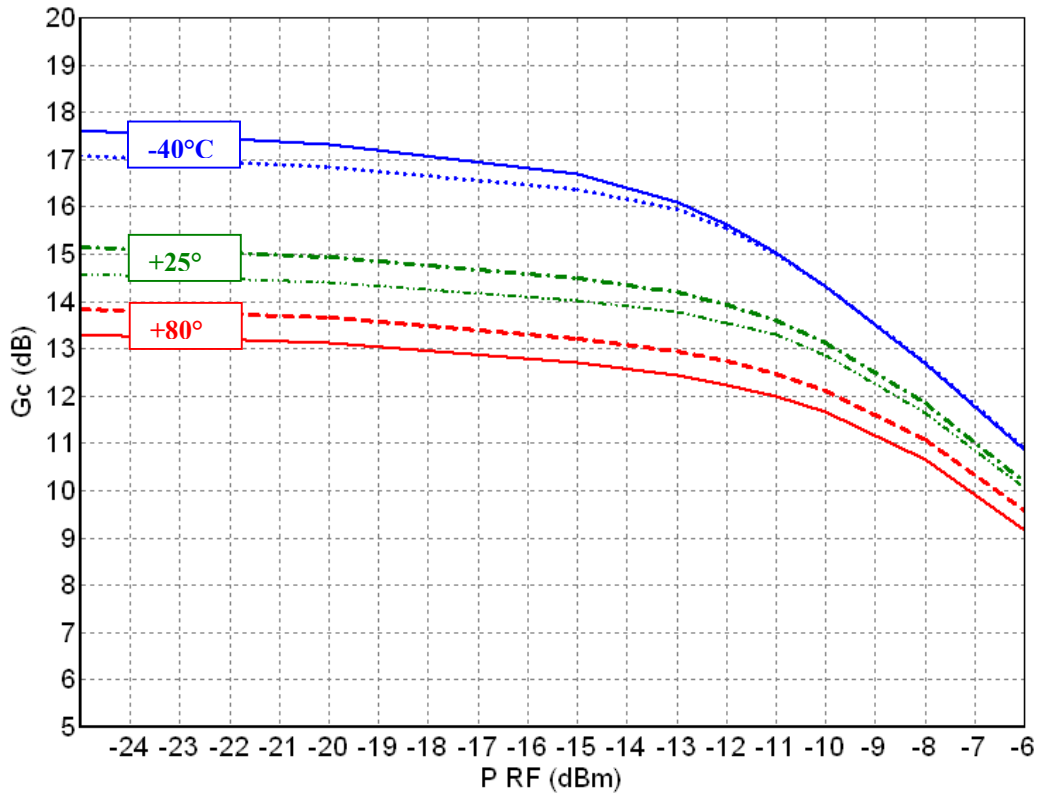

Compression vs P_{RF} (inf. & sup. Mode) @ F_{RF}=26GHz & F_{IF}=2GHz
P_{LO}=2dBm

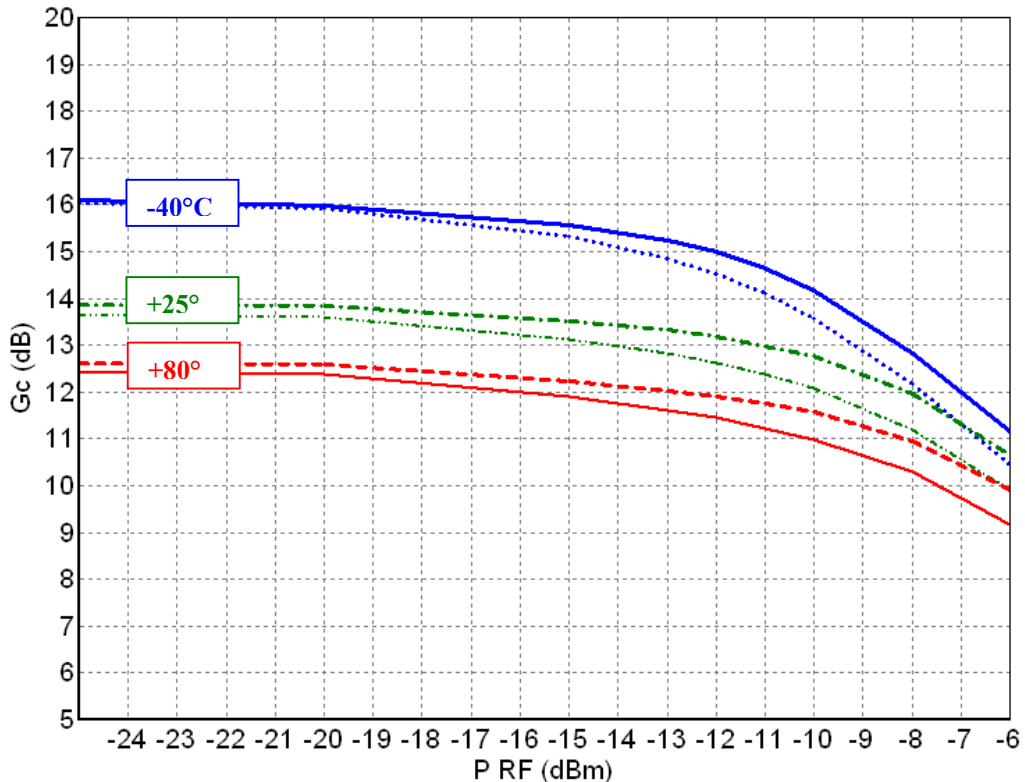

Preliminary

Input IP3 versus RF power

www.datasheet4u.com

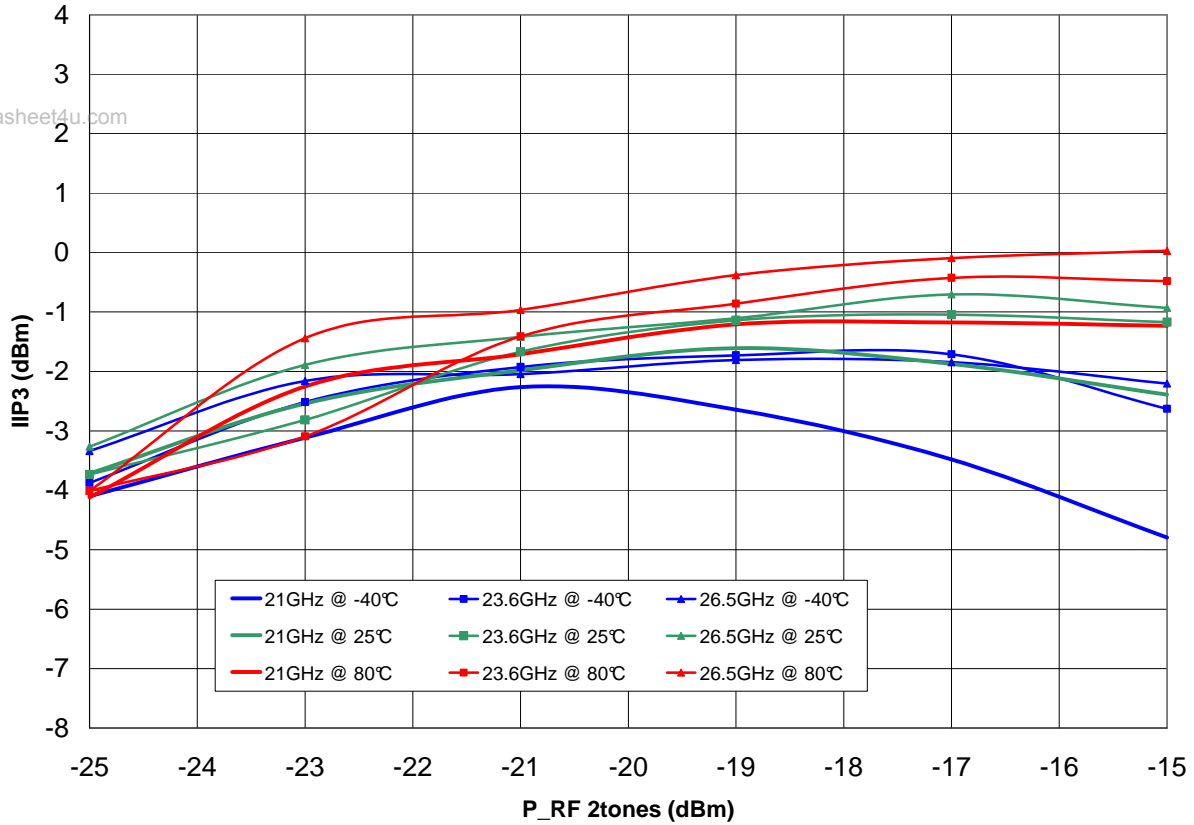

Isolations LO→RF & 2LO→RF @ P_LO=2, 4 & 6dBm

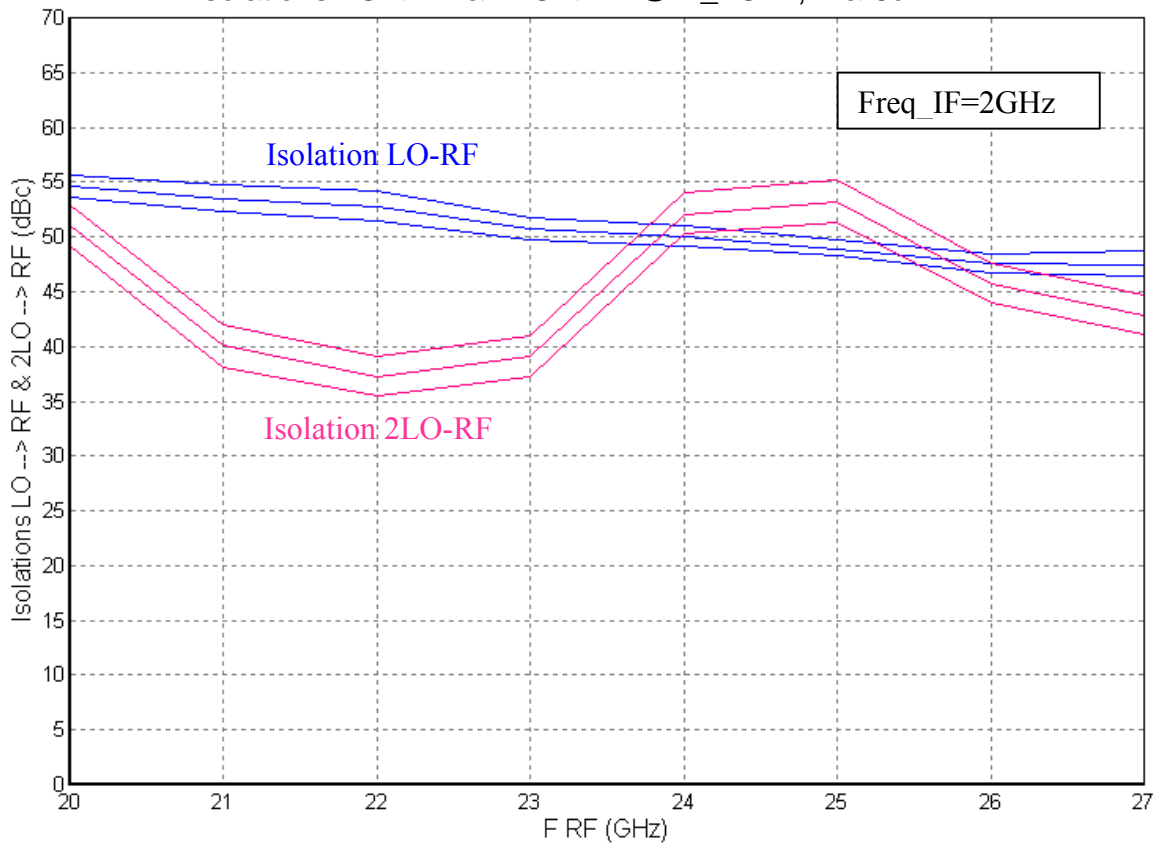

Preliminary

LO Return Loss

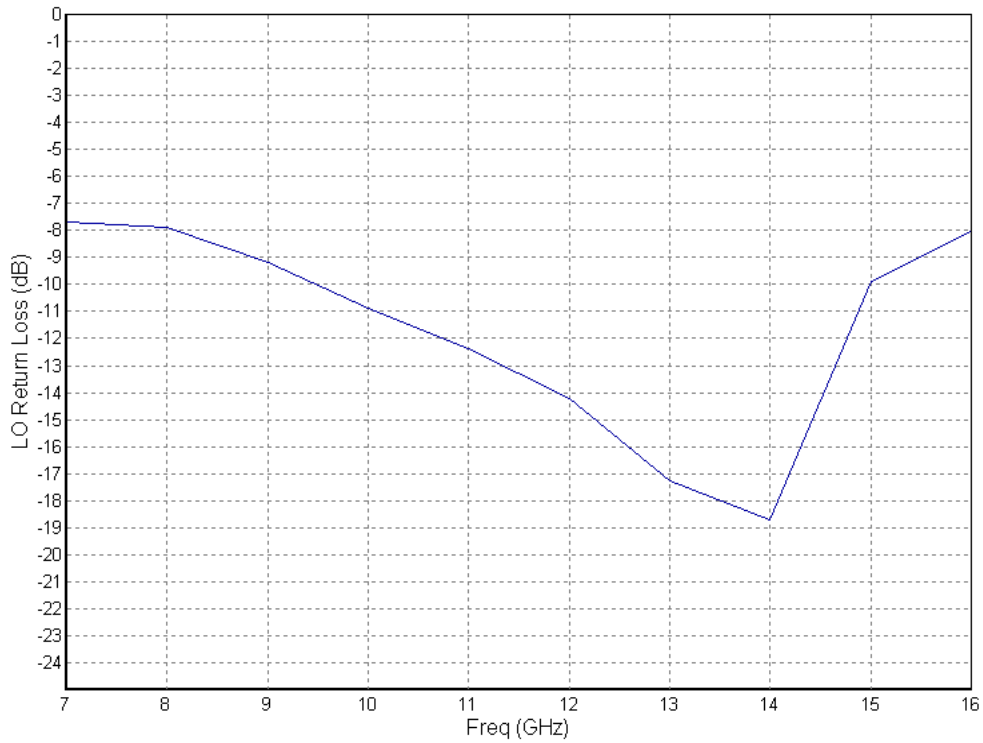

RF Return Loss

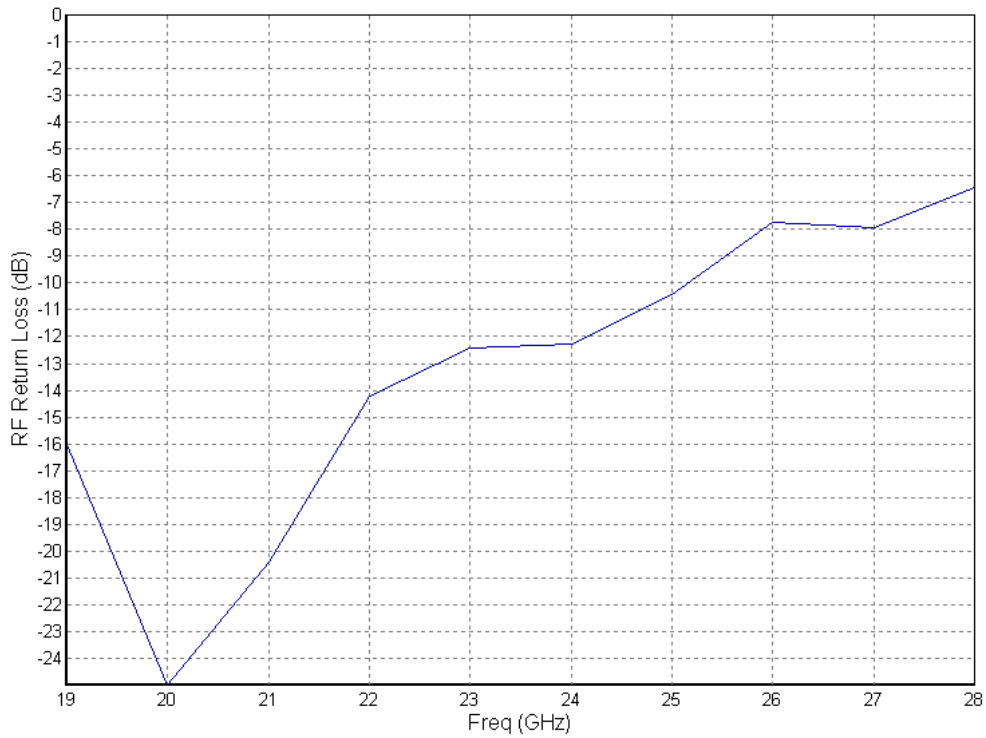

www.datasheet4u.com



Preliminary

Package outline:

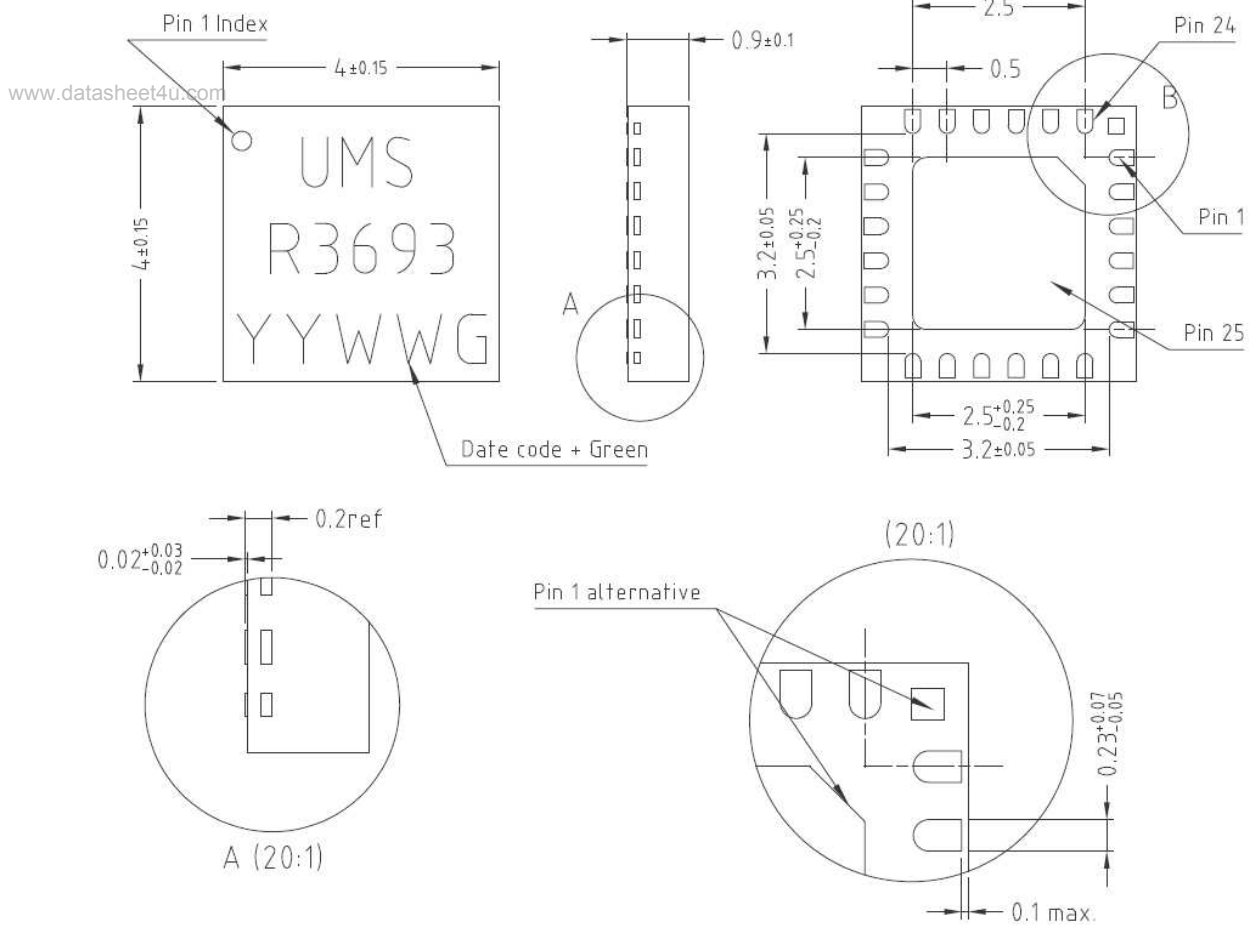

Matt tin, Lead Free
Units
From the standard
Pin 25 (paddle): GND

(Green)
mm
JEDEC MO-220

- | | |
|----------|--------------|
| 1- NC | 13- GND |
| 2- GND | 14- GND |
| 3- GND | 15- LO IN |
| 4- RF IN | 16- GND |
| 5- GND | 17- GND |
| 6- GND | 18- NC |
| 7- Vdl | 19- I-IF OUT |
| 8- Vgm | 20- GND |
| 9- Vdx | 21- GND |
| 10- NC | 22- Q-IF OUT |
| 11- NC | 23- NC |
| 12- Vgx | 24- NC |

Preliminary

Proposed Assembly board "96401" for the 24L-QFN4x4 product characterization.

www.datasheet4u.com

- Compatible with the proposed footprint.
- Based on typically Ro4003 / 8mils or equivalent.
- Using a microstrip to coplanar transition to access the package.
- Recommended for the implementation of this product on a module board.

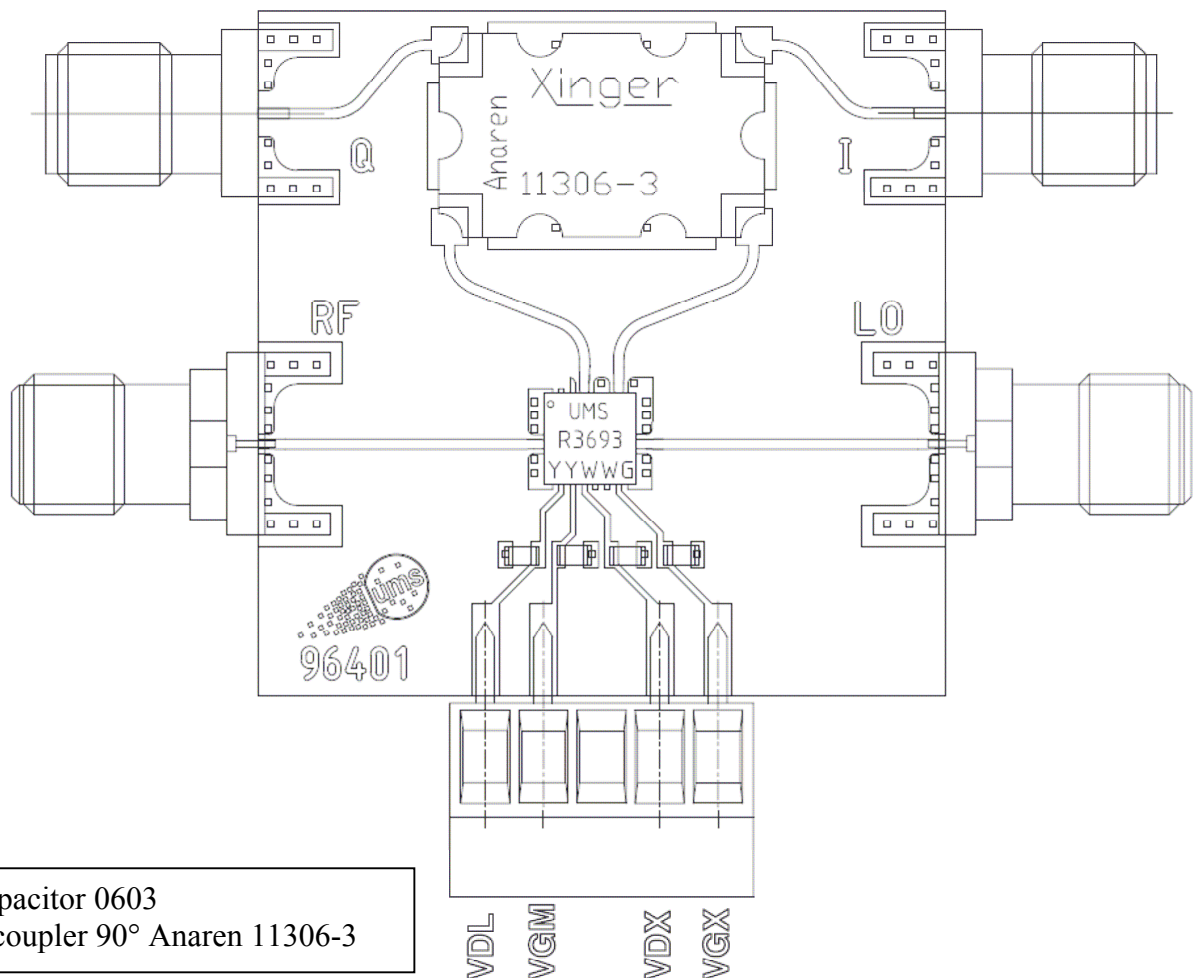

10nF capacitor 0603
Hybrid coupler 90° Anaren 11306-3

The DC connections do not include any decoupling capacitor in package, therefore it is mandatory to provide a good external DC decoupling on the PC board, as close as possible to the package.

The SMD leadless package has been designed for high volume surface mount PCB assembly process. A typical footprint is proposed for the PCB (motherboard) in the previous drawing. For the mounting process standard techniques involving solder paste and a suitable reflow process can be used. For further details, see application note AN0017.

Preliminary

www.datasheet4u.com

Ordering Information

QFN 4x4 RoHS compliant package: CHR3693-QDG/XY
Stick: XY = 20 Tape & reel: XY = 21

Information furnished is believed to be accurate and reliable. However **United Monolithic Semiconductors S.A.S.** assumes no responsibility for the consequences of use of such information nor for any infringement of patents or other rights of third parties which may result from its use. No license is granted by implication or otherwise under any patent or patent rights of **United Monolithic Semiconductors S.A.S.**. Specifications mentioned in this publication are subject to change without notice. This publication supersedes and replaces all information previously supplied. **United Monolithic Semiconductors S.A.S.** products are not authorised for use as critical components in life support devices or systems without express written approval from **United Monolithic Semiconductors S.A.S.**