

Color Television Operating Instructions

www.DataSheet4U.com

Panasonic®

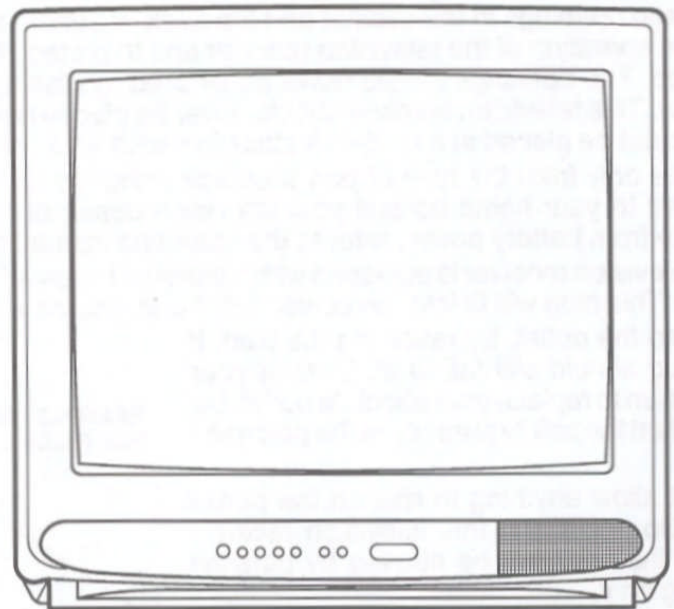

CT-20R13

Read these instructions completely before operating this set.
Contents subject to change without notice or obligation.

Safety Instructions

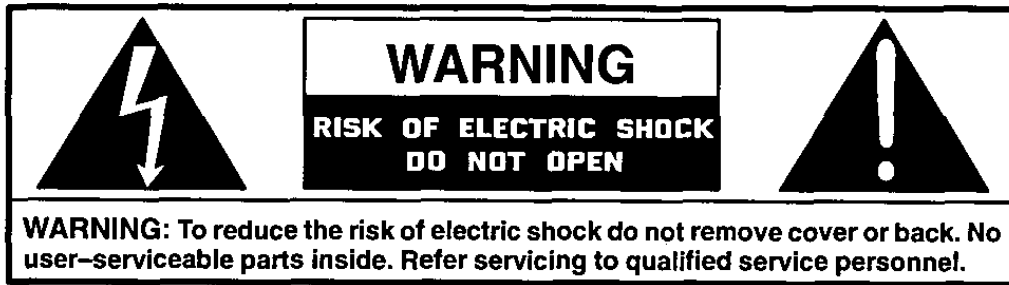

The lightning flash with arrow-head within a triangle is intended to tell the user that parts inside the product are a risk of electric shock to persons.



The exclamation point within a triangle is intended to tell the user that important operating and servicing instructions are in the papers with the appliance.

Note To CATV System Installer: This reminder is provided to call the CATV system installer's attention to Article 20-40 of the NEC that provides guidelines for proper grounding and, in particular, specifies that the cable ground shall be connected to the grounding system of the building, as close to the point of cable entry as practical.

Safety Instructions For Television Receivers

- Read and apply the operating instructions provided with your television receiver.
- Read all of the instructions given here and retain them for later use.
- Unplug this television receiver from the wall outlet before cleaning. Do not use liquid or aerosol cleaners. Use a damp cloth for cleaning.
- Do not use attachments not recommended by the television receiver manufacturer as they may cause hazards.
- Do not use this television receiver near water. For example: Avoid placing it near a bathtub, washbowl, kitchen sink, or laundry tub, in a wet basement, or near a swimming pool, etc.
- Do not place this television receiver on an unstable cart, stand, or table. The television receiver may fall, causing serious injury to a child or adult, and serious damage to the appliance. Use only with a cart or stand recommended by the manufacturer, or sold with the television receiver. Wall or shelf mounting should follow the manufacturer's instructions, and should use a mounting kit approved by the manufacturer.

A. An appliance and cart combination should be moved with care. Quick stops, excessive force, and uneven surfaces may cause the appliance and cart combination to overturn.



• Slots and openings in the cabinet and the back or bottom are provided for ventilation, and to insure reliable operation of the television receiver and to protect it from overheating. These openings must not be blocked or covered. The openings should never be blocked by placing the television receiver on a bed, sofa, rug or other similar surface. This television receiver should never be placed near or over a radiator or heat register. This television receiver should not be placed in a built-in installation such as a bookcase unless proper ventilation is provided.

• Operate only from the type of power source indicated on the marking label. If you are not sure of the type of power supplied to your home consult your television dealer or local power company. For television receivers designed to operate from battery power, refer to the operating instructions.

• This television receiver is equipped with a polarized alternating-current line plug (a plug having one blade wider than the other). This plug will fit into the power outlet only one way. This is a safety feature. If you are unable to insert the plug fully into the outlet, try reversing the plug. If the plug should still fail to fit, contact your electrician to replace your obsolete outlet. Do not defeat the safety purpose of the polarized plug.

0. Do not allow anything to rest on the power cord. Do not locate this television receiver where the cord will be abused by persons walking on it.

1. Follow all warnings and instructions marked on the television receiver.

2. Do not overload wall outlets and extension cords as this can result in fire or electric shock.

3. Never push objects of any kind into this television receiver through cabinet slots as they may touch dangerous voltage points or short out parts that could result in a fire or electric shock. Never spill liquid of any kind on the television receiver.

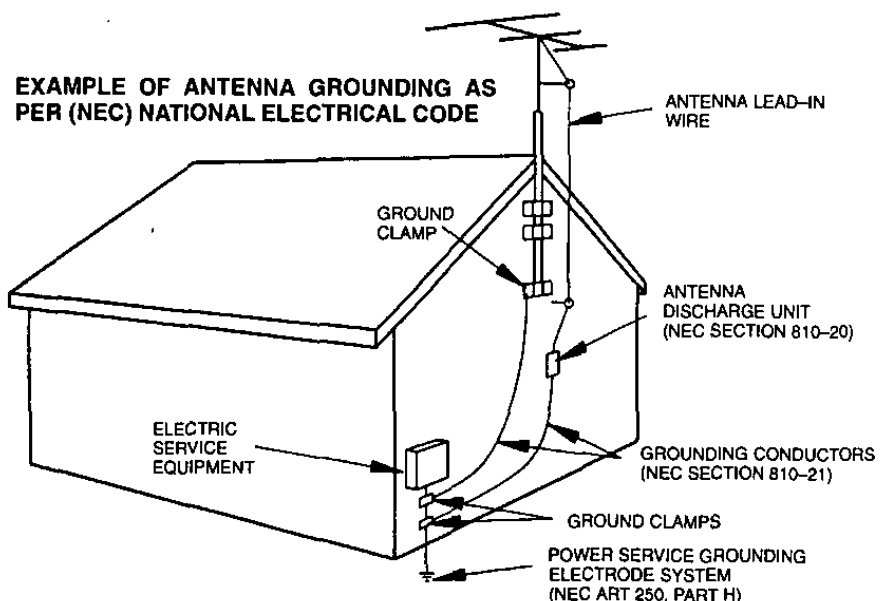

14. If an outside antenna is connected to the television equipment, be sure the antenna system is grounded so as to provide some protection against voltage surges and built up static charges. In the U.S. Section 810 of the National Electrical Code and in Canada Part 1 of the Canadian Electrical Code provides information with respect to proper grounding of the mast and supporting structure, grounding of the lead-in wire to an antenna discharge unit, size of grounding conductors, location of antenna-discharge unit, connection to grounding electrodes, and requirements for the grounding electrode. See Figure.
15. For added protection for this television receiver during a lightning storm, or when it is left unattended and unused for long periods of time, unplug it from the wall outlet and disconnect the antenna. This will prevent damage to the receiver due to lightning and power-line surges.
16. An outside antenna system should not be located in the vicinity of overhead power lines or other electric light or power circuits, or where it can fall into such power lines or circuits. When installing an outside antenna system extreme care should be taken to keep from touching such power lines or circuits as contact with them might be fatal.
17. Unplug this television receiver from the wall outlet, and refer servicing to qualified service personnel under the following conditions:
 - a. When the power cord or plug is damaged or frayed.
 - b. If liquid has been spilled into the television receiver.
 - c. If the television receiver has been exposed to rain or water.
 - d. If the television receiver does not operate normally by following the operating instructions. Adjust only those controls that are covered by the operating instructions as improper adjustment of other controls may result in damage and will often require extensive work by a qualified technician to restore the television receiver to normal operation.
 - e. If the television receiver has been dropped or the cabinet has been damaged.
 - f. When the television receiver exhibits a distinct change in performance – this indicates a need for service.
18. Do not attempt to service this television receiver yourself as opening or removing covers may expose you to dangerous voltage or other hazards. Refer all servicing to qualified service personnel.
19. When replacement parts are required, be sure the service technician has used replacement parts specified by the manufacturer that have the same characteristics as the original part. Unauthorized substitutions may result in fire, electric shock, or other hazards.
20. Upon completion of any service or repairs to this television receiver, ask the service technician to perform routine safety checks to determine that the television is in safe operating condition.
21. **WARNING: To prevent fire or shock hazard, do not expose this appliance to rain or moisture.**
22. **CAUTION: TO PREVENT ELECTRIC SHOCK DO NOT USE THIS (POLARIZED) PLUG WITH A RECEPTACLE OR OTHER OUTLET UNLESS THE BLADES CAN BE FULLY INSERTED TO PREVENT BLADE EXPOSURE.**

NOTE: This equipment is designed to operate in the U.S.A., Canada and other countries where the broadcasting system and AC house current is exactly the same as in the U.S.A. and Canada.

Important Information Regarding Use of Video Games, Computers, Teletext or Other Fixed Image Displays.

The extended use of fixed image program material can cause a permanent "shadow image" on the picture tube. This background image is viewable on normal programs in the form of a stationary fixed image. This type of irreversible picture tube deterioration can be limited by observing the following steps:

- A. Reduce the brightness/contrast setting to a minimum viewing level.
- B. Do not display the fixed image for extended periods of time.
- C. Turn the power off when not in actual use.

NOTE: The marking or retained image on the picture tube resulting from fixed image use is not an operating defect and as such is not covered by Warranty. This product is not designed to display fixed image patterns for extended periods of time.

Specifications

- Power Source:** 120V, 60Hz, AC
Channel Capability: 181 channels (See chart)
 VHF 2-13, UHF 14-69, Cable 125 channels
Video Input Jack: 1V p-p, 75 ohm, phono jack type
Audio Input Jacks: High impedance – 10K ohm, 500mV rms
Stereo Sound
Closed Caption Display

Channel Capability Chart

BAND	USA/CAN
VHF	12
UHF	56
CABLE (Mid-Band)	15
CABLE (Super Band)	14
CABLE (Hyper Band)	28
CABLE (Ultra Band)	56
TOTAL CHANNELS	181

Specifications are subject to change without notice or obligation.

Introduction

Congratulations on Your New Purchase

Your new video component features an all solid state chassis which is designed to give you many years of enjoyment. It was thoroughly tested and adjusted at the factory for best performance.

In order for you to take full advantage of your new video component, please read and follow the installation and operating instructions supplied with this product.

Customer's Record

The model and serial number of this product may be found on its back cover. You should note the model and serial number in the space provided and retain this book as a permanent record of your purchase to aid in identification in the event of theft or loss.

Model Number: _____ Serial Number: _____

Table of Contents

Safety Instructions	2	Sleep Button	11
Specifications	3	Main Menu (Icons)	12
Introduction	4	Trilingual Menu Selection	12
Installation	5	Picture Adjustments	13
Receiver Location	5	Picture Norm	13
Optional External Equipment Connections	5	Color, Tint, Brightness, Picture and Sharpness	13
AC Power Supply Cord	5	Audio Mode	14
Remote Control Battery Installation	5	Stereo/SAP/Mono	14
Antenna/Cable Connections	6	Game Guard	15
Other Video Equipment	6	Lock Game Guard	15
Optional Equipment Connection and Operation ..	7	Unlock Game Guard	15
Video/Audio Connection	7	Channel Caption	16
Location of Controls (Remote and Receiver)	8	Timer Features	17
Quick Reference Control Operation	8	Sleep Timer	17
Remote Quick Reference Functional Key Chart ..	9	Program Timer	17
Control Operation	10	Set-Up Features	18
Power Button	10	Set Time	18
VOL (Volume) Buttons	10	Ant (Antenna)	18
Mute Button	10	Auto Prog (Program)	19
CH (Channel) Buttons	10	Manual Prog (Program)	19
Keyboard "0 through 9" Buttons	10	CC (Closed Caption) On Mute	20
Recall Button	11	CC (Closed Caption) Mode	21
TV/Video Button	11	Trilingual Menu System	22
R-Tune (Rapid Tune) Button	11	Care & Cleaning	23
		Power Loss	23
		Troubleshooting Chart	24

Installation

Receiver Location

This unit is intended to be used with an optional stand or entertainment center. Consult your dealer for available options. Locate for comfortable viewing. Avoid placing where sunlight or other bright light (including reflections) will fall on the screen.

Use of some types of fluorescent lighting may reduce remote control transmitter range.

Adequate ventilation is essential to prevent internal component failure. Keep away from areas of excessive heat or moisture.

To insure optimum color purity do not position magnetic equipment (motors, fans, other speakers, etc.) nearby.

Optional External Equipment Connections

The Video/Audio connections between components can be made with shielded video and audio cables. For best performance, video cables should utilize 75 ohm coaxial shielded wire. Cables are available from your dealer or electronic supply house.

Before you purchase any cables, be sure you know what type of output and input connectors your various components require. Also determine the length of cable you'll need.

AC Power Supply Cord

CAUTION: TO PREVENT ELECTRIC SHOCK, MATCH WIDE BLADE OF PLUG TO WIDE SLOT OF AC OUTLET AND FULLY INSERT. DO NOT USE THIS (POLARIZED) PLUG WITH A RECEPTACLE OR OTHER OUTLET UNLESS THE BLADE CAN BE FULLY INSERTED TO PREVENT BLADE EXPOSURE.

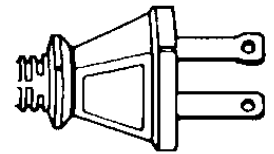

Polarized Plug

Remote Control Battery Installation

Batteries: Use two "AA" batteries.

1. Turn the Transmitter face down. To remove bottom cover, press down on marking and slide cover off in the direction indicated.
2. Install the batteries as shown in the battery compartment. (Polarity (+) or (-) must be correct.)
3. Replace the cover and slide in reverse until the lock snaps.
4. For heavy Remote Control use, replace old batteries with Alkaline batteries for longer life.

Precaution on Battery Use

Incorrect installation can cause battery leakage and corrosion that will damage the Remote Control Transmitter.

Observe the Following Precautions:

1. Batteries must be replaced as a pair.
2. Do not combine a used battery with a new one.
3. Do not mix battery types (Example: "Zinc Carbon" with "Alkaline").
4. Do not attempt to charge, short-circuit, disassemble, heat or burn used batteries.
5. Battery replacement is necessary when Remote Control reacts sporadically or stops operating the Receiver.

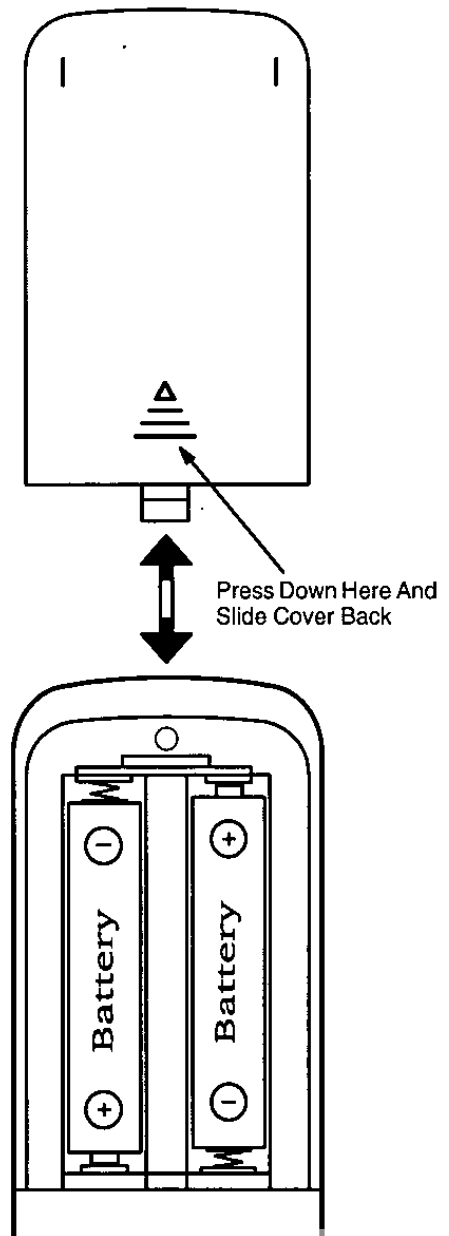

Installation (cont.)

Antenna/Cable Connections

Antenna Connection – For proper reception of VHF/UHF channels an external antenna is required. For best reception an outdoor antenna is recommended. Antenna Mode must be set to TV. (Refer to Antenna Mode section.)

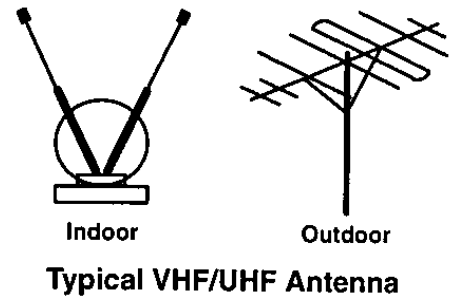

Incoming Cable From Home Antenna (75 Ohm)

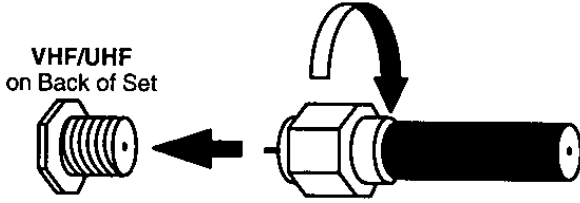

www.DataSheet4U.com

Incoming Cable From Home Antenna (300 Ohm)

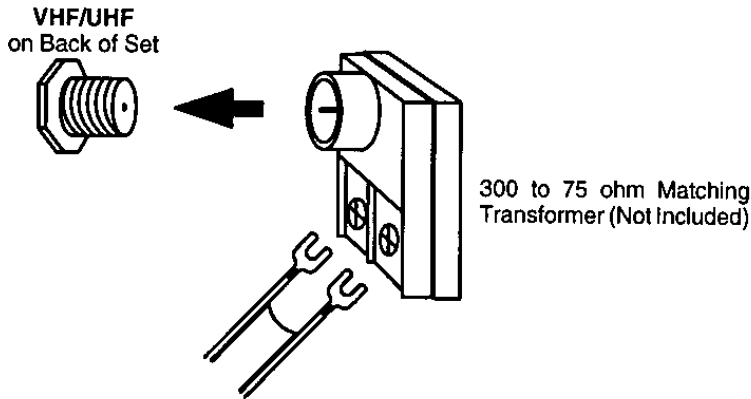

Cable Connection – For reception of cable channels (01~125) connect the cable supplied by your local cable company. Antenna Mode must be set to CABLE. (Refer to Antenna Mode section.)

Incoming 75 Ohm Cable (From Cable Company)

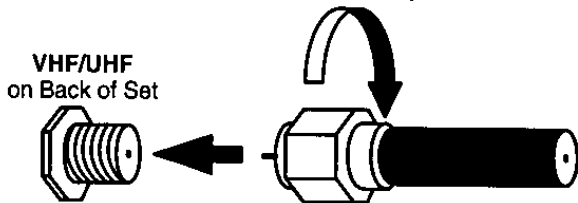

NOTE: Certain cable systems offset some channels to reduce interference or have Premium (scrambled) channels. A cable converter box is required for proper reception. Check with your local Cable company for its compatibility requirements.

Other Video Equipment

VCRs, Video Disc Players, Computers, TV games and Teletext equipment can also be connected to the antenna input connection.

Optional Equipment Connection and Operation

Video/Audio Connection

Operation

1. Connect the Optional Equipment as shown. If Optional Equipment is Stereo, place Optional Equipment in Monaural Mode and use either left or right Audio Output jack.
2. Select Video Input mode by pressing the TV/VIDEO button.
 - TV – (CH and channel number will display On Screen) normal TV operation.
 - VIDEO – (VIDEO will display On Screen) used when optional accessory video equipment (such as VCR, VIDEO DISC player, etc.) is connected to the INPUT JACKS on back of Receiver.
3. Operate optional equipment (VCR–VDP) as instructed in Optional Equipment manual.

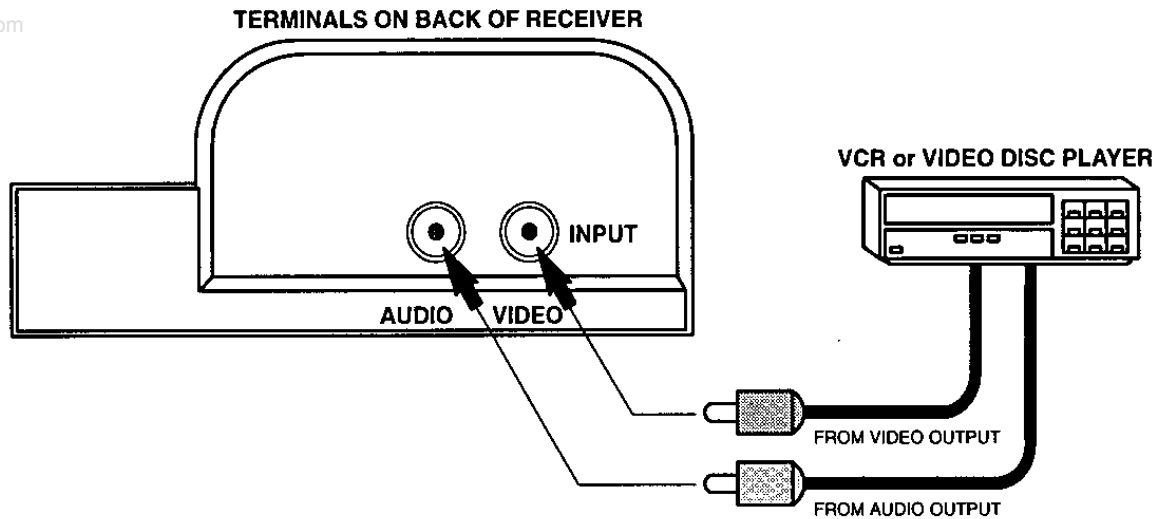



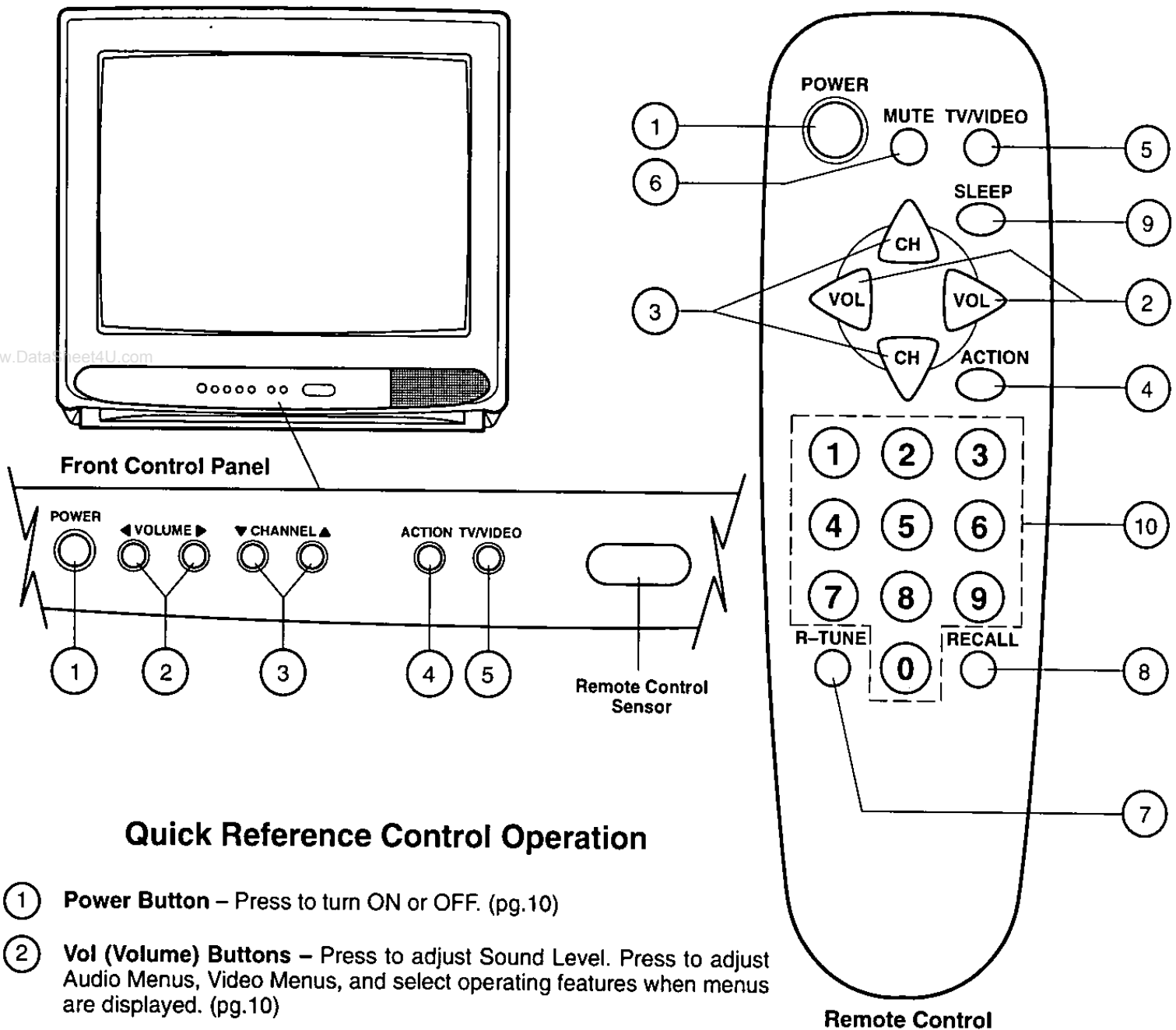









Location of Controls (Remote and Receiver)

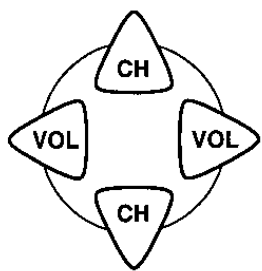

Quick Reference Control Operation

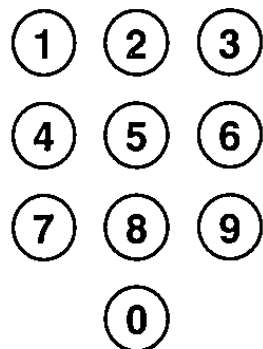
- ① **Power Button** – Press to turn ON or OFF. (pg.10)
- ② **Vol (Volume) Buttons** – Press to adjust Sound Level. Press to adjust Audio Menus, Video Menus, and select operating features when menus are displayed. (pg.10)
- ③ **Ch (Channel) Buttons** – Press to select programmed channels. Press to select desired features when menus are displayed. (pg.10)
- ④ **Action Button** – Press to display Main Menu and access On Screen feature and Adjustment Menus. (pg.12)
- ⑤ **TV/Video Button** – Press to select TV or Video Input. (pg.11)
- ⑥ **Mute Button** – Press to mute sound. A second press returns sound. (pg.10)
- ⑦ **R-Tune (Rapid Tune) Button** – Press to switch between two channels. (pg.11)
- ⑧ **Recall Button** – Press to display Time, status of Sleep Timer, Channel, Video Mode, Audio Mode and Channel Caption (Station Identifier). (pg.11)
- ⑨ **Sleep Button** – Press to select automatic Turn OFF in 30, 60 or 90 minutes. (pg.11)
- ⑩ **Keyboard "0 through 9" Buttons** – Press desired channel number to access any channel. (pg.10)

Remote Quick Reference Functional Key Chart

KEY	OPERATES	FUNCTION
POWER 	TV	Turns TV On and Off
MUTE 	TV	Mutes TV Audio
TV/VIDEO 	TV	Selects the TV Input Mode
ACTION 	TV	Activates TV Menus
	TV  	Channel Up/Down, Menu Navigation
	TV  	Volume Up/Down, Menu Navigation
	TV	Selects Channel Selects code in Game Guard Menu Selects Channel in Channel Caption Menu Selects Channel in Timer Menu
R-TUNE 	TV	Selects Previously Tuned Channel
RECALL 	TV	Displays Channel, Time, and Sleep Time
SLEEP 	TV	Selects 30, 60 Or 90 Minutes For Automatic Turn Off also use to turn sleep timer off by selecting NO

Control Operation

Power Button – Press the POWER button to turn ON. Press again to turn OFF.



Vol (Volume) Buttons – Press the VOLUME (VOL) LEFT or RIGHT button for desired listening level (while On Screen Menus are not displayed).

Located On Remote Control

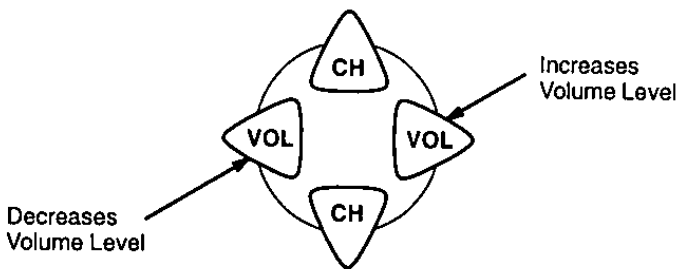

Mute Button – Press the MUTE button to quickly reduce sound level (Mute will appear on screen). Press again to restore sound.



CH (Channel) Buttons

Option 1.

Press the CHANNEL (CH) UP or DOWN button to sequentially scan through programmed channels (while On Screen Menus are not displayed).

Located On Remote Control

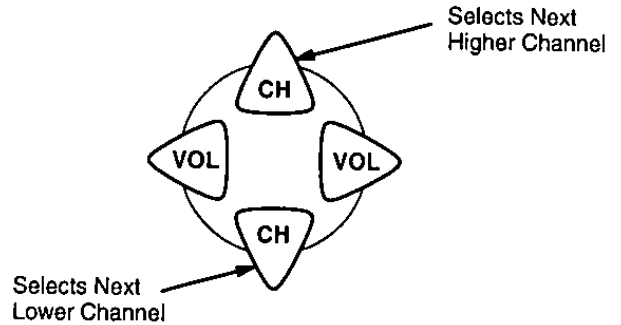

Keyboard “0 through 9” Buttons

Option 2.

Press two digits on keyboard (Example press 0, then 5 for channel 05). For channels over 99, press three digits on keyboard.

Located On Remote Control

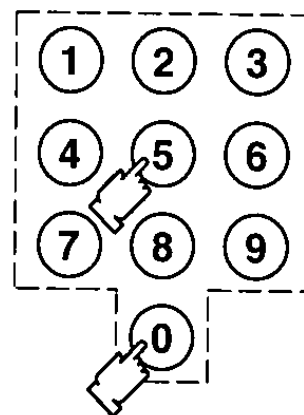

Helpful Hints:

- Helpful information will display On Screen momentarily when Receiver is first turned on and when the channel is changed.
- When using keyboard entry for channels 10, 11 and 12 in the CABLE mode there is a slight delay before channel change because of the capability of tuning cable channels 100 to 125.

Recall Button — Press the RECALL button to review:

- CH Number or Video Input
- Sleep Timer status
- Clock Time
- Channel Caption (Station Identifier)

RECALL

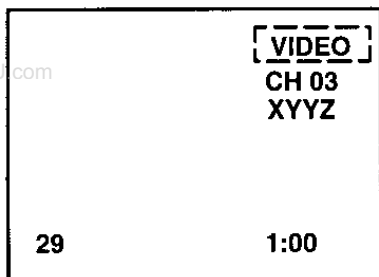

R-Tune (Rapid Tune) Button — Press the R-TUNE (RAPID TUNE) button to instantly switch between the last two channels selected (without any On Screen display being activated).

R-TUNE

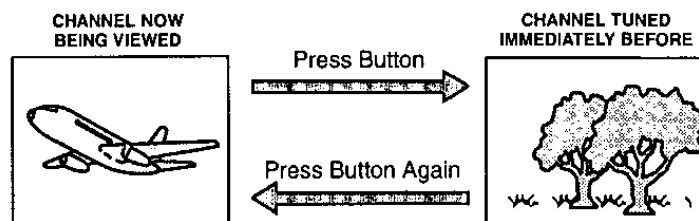

TV/Video Button — Press the TV/VIDEO button to select desired input.

TV/VIDEO



Signal connected to:

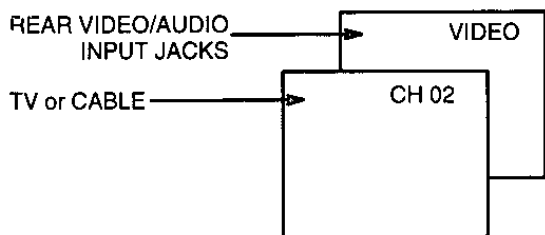

Sleep Button — Press the SLEEP button repeatedly for automatic turn OFF in 30, 60 or 90 minutes as desired. Sleep Timer clock will flash prior to automatic turn OFF.

NOTE: Display will flash 3, 2 and 1 to indicate the last three remaining minutes prior to turn OFF. To deactivate Sleep Timer, press the Sleep button continuously until the display reads "NO".

SLEEP

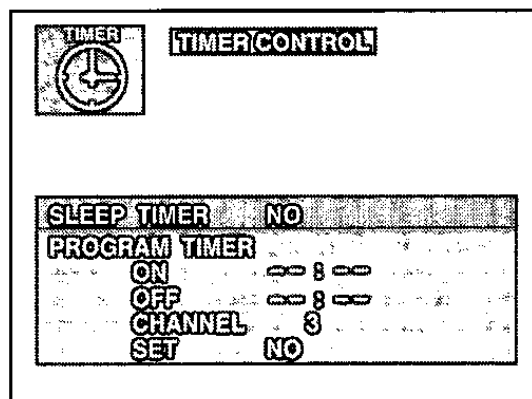

Main Menu Icons Selection

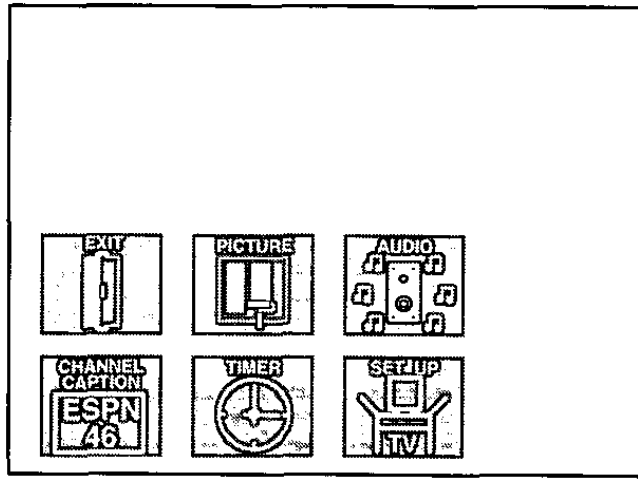

Located On Remote Control

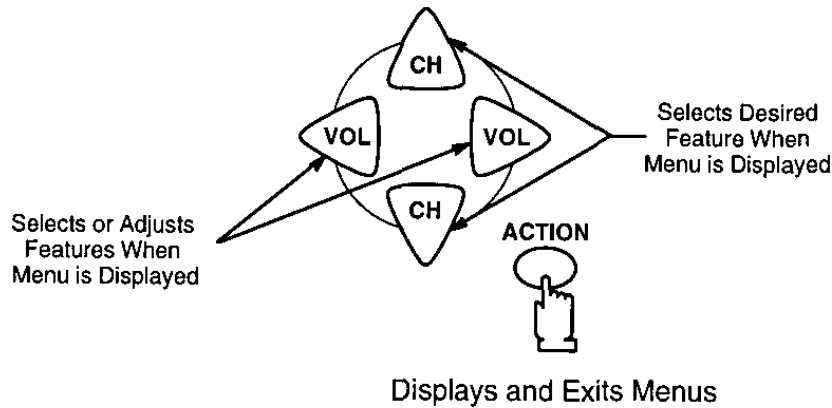

1. Press the ACTION button to display the Main Menu with Icons.
2. Press the CH UP or DOWN and the VOL LEFT or RIGHT buttons to select the desired Icon when the Main Menu is displayed (selected Icon will be indicated in Red). Press the VOL buttons for left and right movement and the CH buttons for up or down movement.
3. Press the ACTION button after selecting the desired Icon to access sub menus.
4. To exit the Main Menu first select the EXIT Icon, then press the ACTION button.

Trilingual Menu Selection

The Language Menu is factory set to ENGLISH. Follow these instructions to change the Language Menu to Spanish or French and back to English.

1. Press the ACTION button to display the Main Menu.
2. Press the CH UP/DOWN and VOL LEFT/RIGHT buttons to highlight the SET-UP Icon.
3. Press the ACTION button to display the SET-UP Menu.

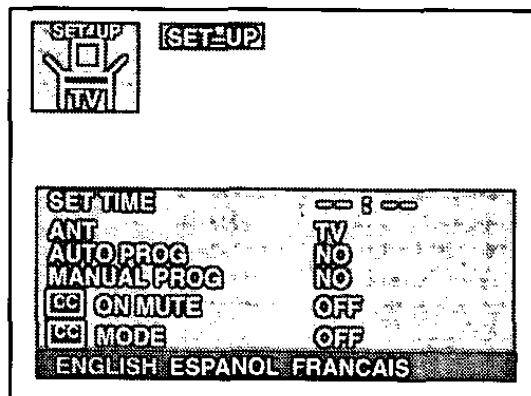

4. Press the CH UP or DOWN button to highlight "ENGLISH ESPAÑOL FRANCAIS."
5. Press the VOL LEFT or RIGHT button to select "ENGLISH", "ESPAÑOL" or "FRANCAIS".
6. Press the ACTION button twice to exit the SET-UP Menu.

Lock

Located On Remote Control

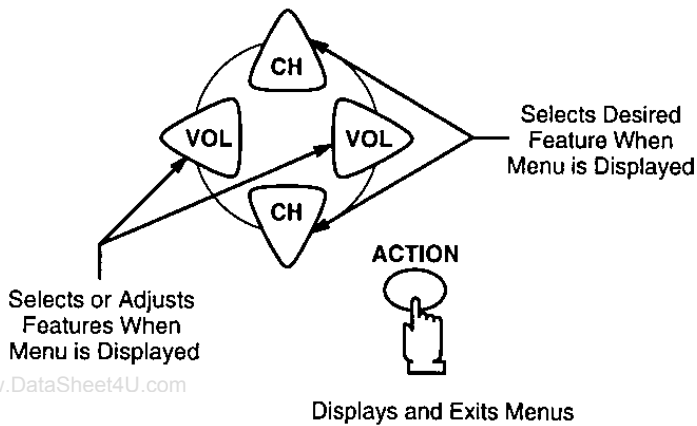

www.DataSheet4U.com

Displays and Exits Menu

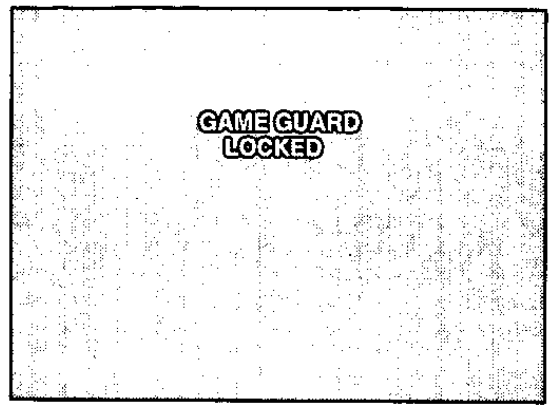

Game Guard Activated

Unlock Game Guard

To unlock the Game Guard feature, repeat steps 1 through 3. Enter the same 3 digit code previously used in step 5 with Remote Control Keyboard.

Lock Game Guard – Prevents video games and other video sources from being viewed. Channel 3, 4 and video inputs are locked out for 12, 24 or 48 hours.

NOTE: Be sure to understand this feature before attempting its use. Use a code that you will easily remember or write down the code on a piece of paper.

1. Press the ACTION button to display the Main Menu.
2. Press the CH UP/DOWN and VOL LEFT/RIGHT buttons to highlight the Lock Icon.
3. Press the ACTION button to display the Lock (Game Guard) Menu.

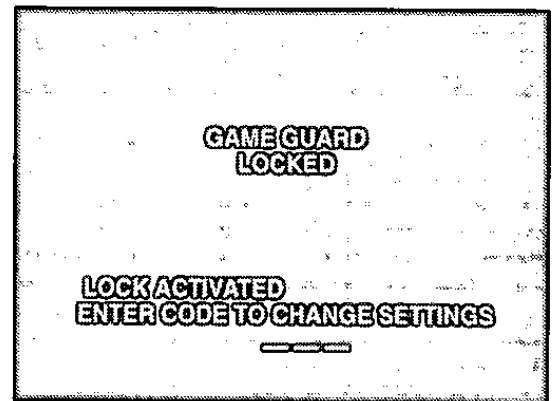

Enter Same 3 Digit Code Previously Used

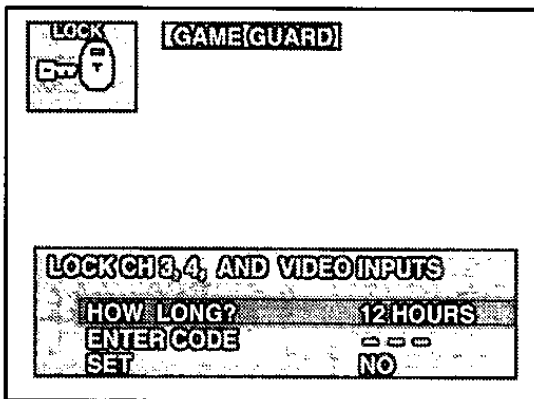

4. "HOW LONG" should already be highlighted. Press the VOL RIGHT button to select the desired amount of time (12, 24 or 48 hours) for Game Guard (Lock-out) to be activated.
5. Press the CH DOWN button to highlight "ENTER CODE". Then enter a 3 digit code with the Remote Control Keyboard. "SET" should be highlighted after entering the last digit.

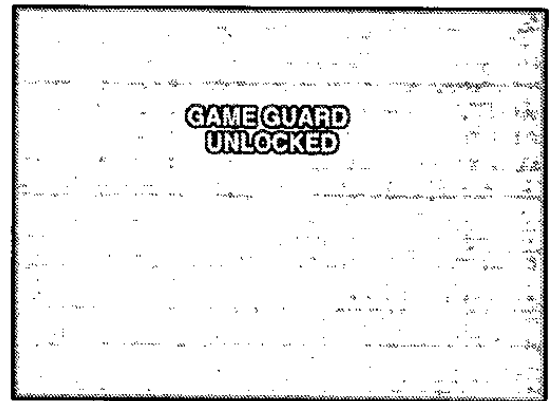

If 3 Digit Code Is The Same

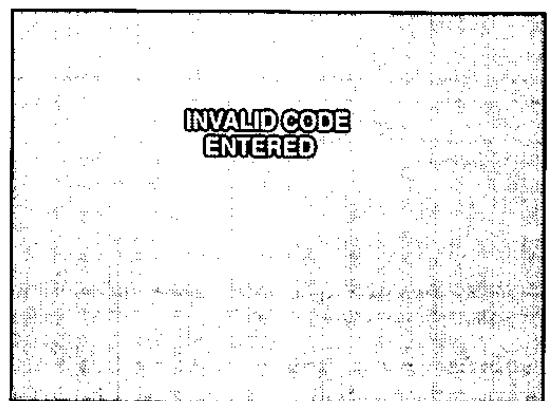

If 3 Digit Code Is Not The Same

IMPORTANT NOTE: Use a code you can easily remember or write down the code on a piece of paper.

6. Press the VOL LEFT or RIGHT button after entering three digit code. "Game Guard Locked" will display On Screen.

Channel Caption

This feature allows you to enter the call names of up to 30 stations into memory (using up to 4 characters for each station). The call name will then display along with the channel number when changing channels or pressing RECALL.

Located On Remote Control

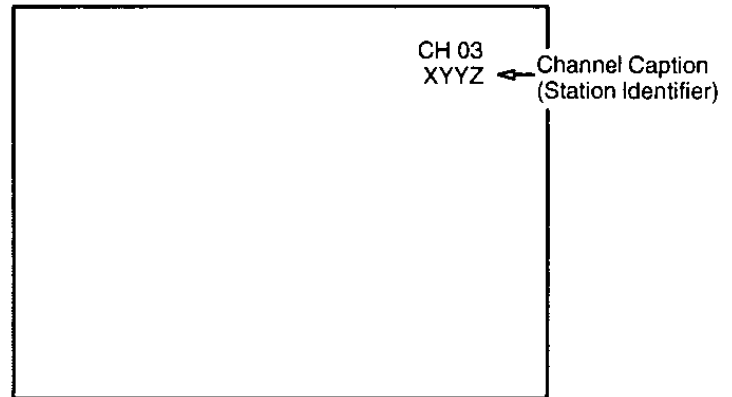
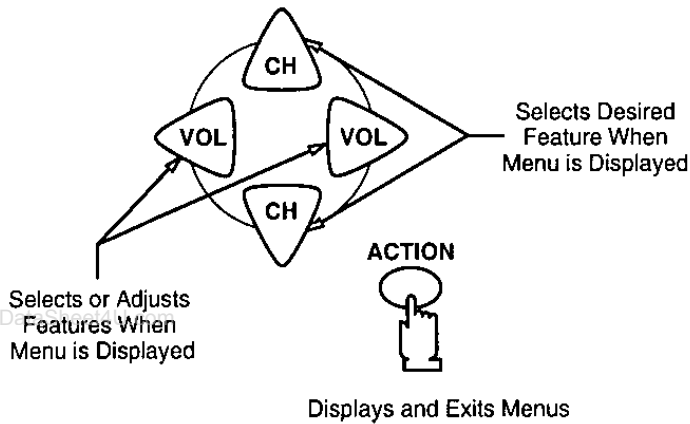

1. Press the ACTION button to display the Main Menu.
2. Press the CH UP/DOWN and VOL LEFT/RIGHT buttons to highlight the Channel Caption Icon.
3. Press the ACTION button to select and display the Channel Caption Menu.

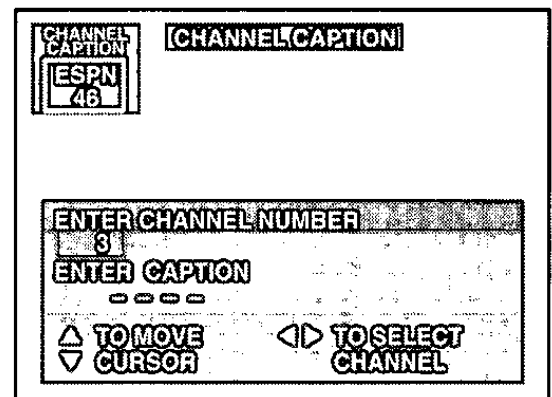

4. Press the VOL LEFT or RIGHT button, or use the Remote Control Keyboard (0-9), to enter the channel number you wish to assign a Station Identifier.
5. Press the CH DOWN button to highlight "ENTER CAPTION".
6. Press the VOL LEFT or RIGHT button to select first character in Station Identifier. Then press the CH DOWN button to move cursor to the second position and repeat until the complete Station Identifier is entered (up to 4 characters).
7. Press the CH UP or DOWN button to highlight "ENTER CHANNEL NUMBER". Then repeat steps 4 through 6 to continue adding Channel Station Identifier(s).
8. Press the ACTION button twice to exit the Channel Caption Menu.

NOTE: To delete a Channel Caption (Station Identifier) from memory all four character positions in the "ENTER CAPTION" area must display a dash mark (-).

Helpful Hints:

When the Maximum amount of station identifiers are entered, "FULL" will be displayed in the caption position.

Timer Features

- Sleep Timer
- Program Timer

Special Feature:

Automatic turn "OFF" after 90 minutes.

The TV has a special feature that will shut itself OFF after 90 minutes when turned ON by the program timer unless a function key is pressed during the 90 minutes.

This feature is useful so that the TV will not remain ON unattended for an extended period of time.

Programming the OFF timer will also cancel the automatic OFF feature.

Sleep Timer – This feature is used for automatic turn off in 30, 60 or 90 minutes.

NOTE: Display will flash 3, 2 and 1 to indicate the last three remaining minutes prior to turn off. The Recall display will also appear.

1. Press the ACTION button to display the Main Menu.
2. Press the CH UP/DOWN and VOL LEFT/RIGHT buttons to highlight the Timer Icon.
3. Press the ACTION button to display the Timer Control Menu. SLEEP TIMER position should already be highlighted. If not, press CH UP/DOWN to highlight SLEEP TIMER.

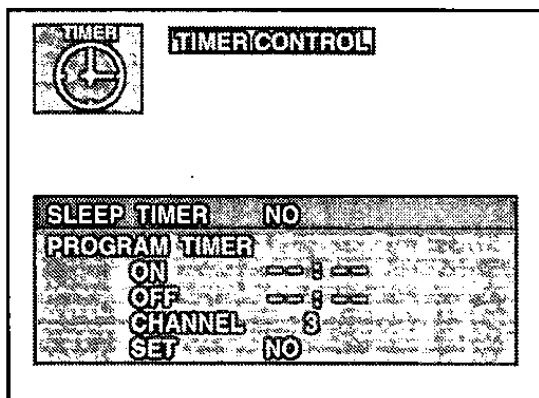

4. Press the VOL RIGHT button to select 30, 60 or 90 minutes (Sleep Timer will be activated).
5. Press the ACTION button twice to exit the Timer Control Menu.

NOTE: To deactivate Sleep Timer repeat steps 1 through 4. In step 4 select "NO" instead of minutes.

Helpful Hints:

Press the RECALL button to display the remaining minutes for Sleep Timer, the time will display in the bottom left corner.

Program Timer – This feature is capable of turning the TV on, tuned to a desired channel and off at a predetermined time (one day or daily).

NOTE: The clock must be set for this feature to operate. (Refer to the Set-Up Menu to set time.)

1. Press the ACTION button to display the Main Menu.
2. Press the CH UP/DOWN and VOL LEFT/RIGHT buttons to highlight the Timer Icon.
3. Press the ACTION button to display the Timer Control Menu.

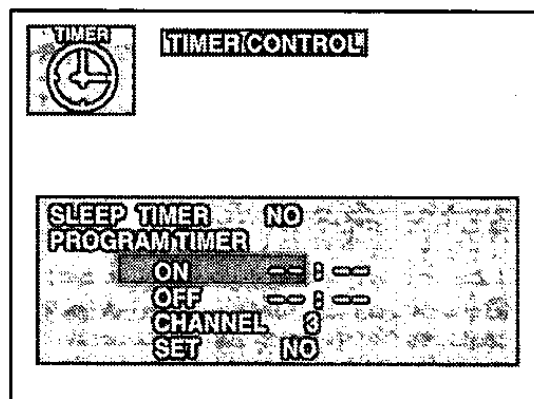

4. Press the CH DOWN button to highlight "ON" (time).
5. Press the VOL LEFT or RIGHT button repeatedly to set hours (set AM/PM accordingly).
6. Press the CH DOWN button to highlight the minutes position.
7. Press the VOL LEFT or RIGHT button repeatedly to set minutes.
8. Press the CH DOWN button to highlight "OFF" (time).
9. Repeat steps 5 through 7 for setting "OFF" (time).
10. Press the CH DOWN button to highlight "CHANNEL".
11. Press the VOL LEFT or RIGHT button or use the Remote Control Keyboard to enter the channel number desired when the set turns "ON".
12. Press the CH DOWN button to highlight "SET".
13. Press the VOL RIGHT button to select:
 - NO – not activated.
 - ONE DAY – activated.
 - DAILY – activated.

NOTE: To deactivate Program Timer select "NO" in step 13.

14. Press the ACTION button twice to exit the Timer Control Menu.

Helpful Hints:

- If you see "GAME GUARD" in the upper right hand corner, the channel or Video Input you have selected has been locked out.
- If the Program Timer "ON" functions while the set is operating, the set will automatically tune to the channel designated in the Timer Program.

Set-Up Features

- Set Time
- Ant (Antenna)
- Auto Prog (Program)
- Manual Prog (Program)
- CC (Closed Caption) on Mute
- CC (Closed Caption) Mode
- English, Espanol (Spanish) or Francais (French)

Located On Remote Control

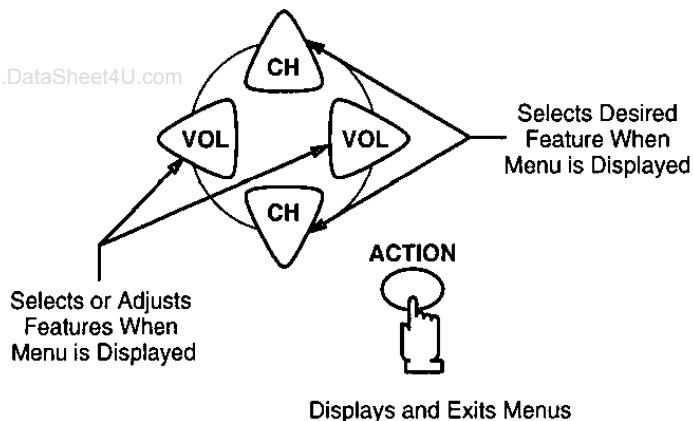

Ant (Antenna) – The proper Input mode must be selected for the type of signal at the antenna input.

- TV mode is used when the Receiver is not connected to a cable TV system, for example when using a VHF/UHF antenna (channels 02 – 69).
- Cable mode is used when the Receiver is connected to a Cable TV system and you are not using a cable company converter box (channels 01 – 125).

1. Press the ACTION button to display the Main Menu.
2. Press the CH UP/DOWN and VOL LEFT/RIGHT buttons to highlight the Set-Up Icon.
3. Press the ACTION button to display the Set-Up Menu.

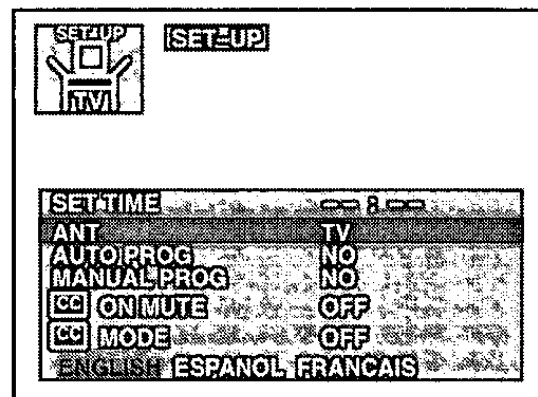

Set Time – Clock (when set) will display on screen at initial “Turn On”, after a channel change and when pressing the RECALL button. The time must be set first in order to operate the Program ON/OFF Timer.

1. Press the ACTION button to display the Main Menu.
2. Press the CH UP/DOWN and VOL LEFT/RIGHT buttons to highlight the Set-Up Icon.
3. Press the ACTION button to display the Set-Up Menu, “SET TIME” will be highlighted.

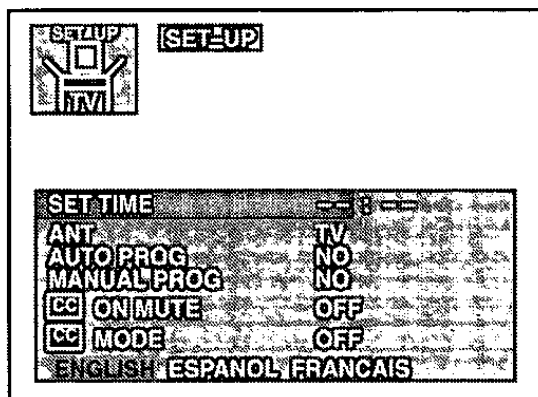

4. Press the VOL LEFT or RIGHT button to set hours (set AM/PM accordingly).
5. Press the CH DOWN button to select minutes position.
6. Press the VOL LEFT or RIGHT button repeatedly to set minutes.
7. Press the ACTION button twice to exit the Set-Up Menu.

4. Press the CH DOWN button to highlight “ANT”.
5. Press the VOL LEFT or RIGHT button to select TV or CABLE.
6. Press the ACTION button twice to exit the Set-Up Menu.

Set-up Features (cont.)

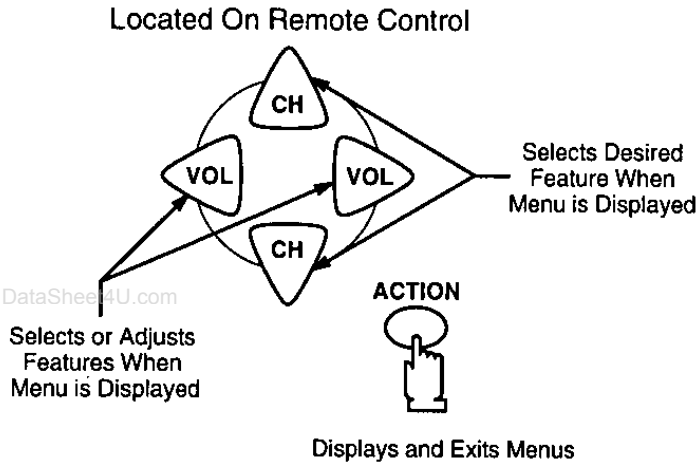

Auto Prog (Program) – This feature allows you to place all channels with a video signal into Channel Scan Memory.

1. Press the ACTION button to display the Main Menu.
2. Press the CH UP/DOWN and VOL LEFT/RIGHT buttons to highlight the Set-Up Icon.
3. Press the ACTION button to display the Set-Up Menu.

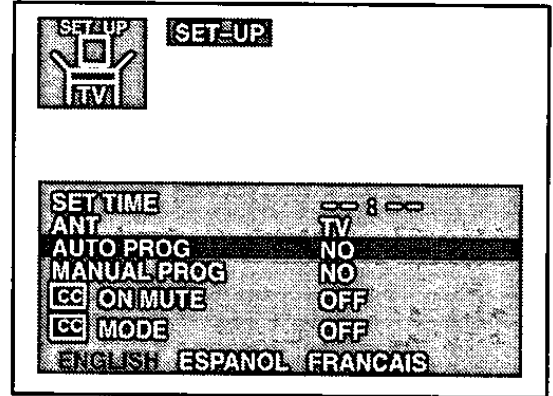

4. Press the CH DOWN button – to highlight “AUTO PROG”.
5. Press the VOL LEFT or RIGHT button to start Auto Programming. Channels will automatically advance until all channels have been scanned.
6. Press the ACTION button twice after completion of Auto Programming to exit the Set-Up Menu.

NOTE: Channel numbers with signal present will turn blue which indicates stored in Channel Scan Memory.

Set-up Features (cont.)

Located On Remote Control

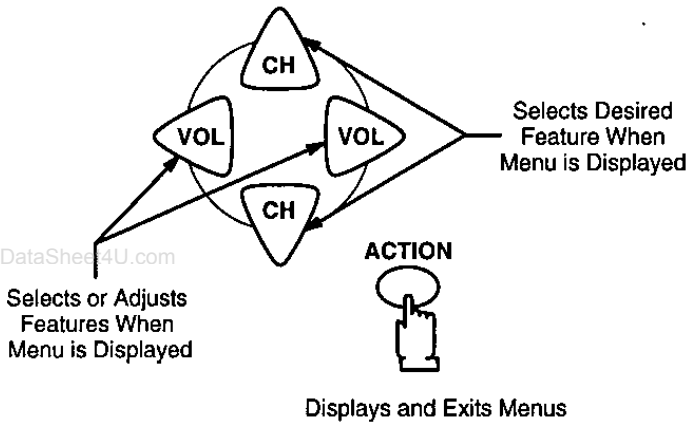

Manual Prog (Program) – This feature allows you to select which channels are placed into Channel Scan Memory.

1. Press the ACTION button to display the Main Menu.
2. Press the CH UP/DOWN and VOL LEFT/RIGHT buttons to highlight the Set-Up Icon.
3. Press the ACTION button to display the Set-Up Menu.

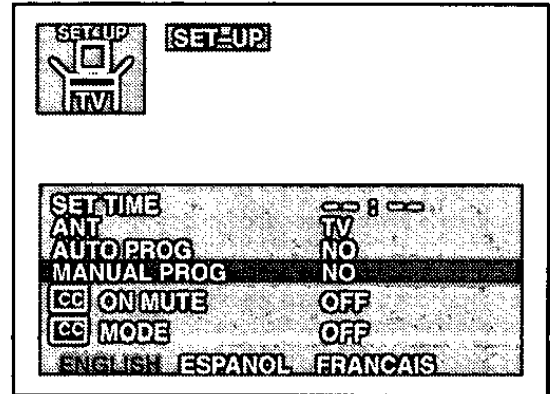

4. Press the CH DOWN button to highlight "MANUAL PROG".
5. Press the VOL LEFT or RIGHT button to display the Manual Programming Menu.

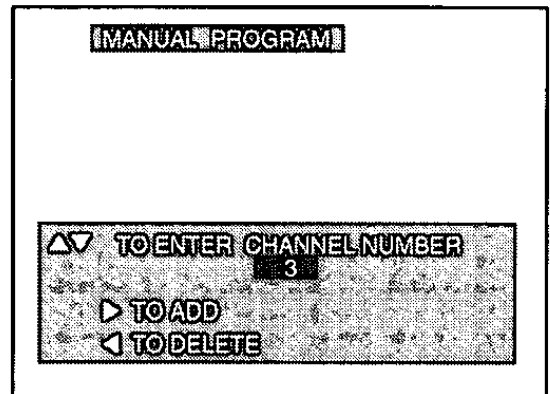

6. Use the CH UP or DOWN button or the Remote Keyboard "0 through 9" buttons to select channels.
7. Press the VOL RIGHT button to **add** channel(s) to memory (Blue). Press the VOL LEFT button to **delete** channels from memory (Yellow).
8. Repeat steps 6 and 7 to continue adding or deleting channels.
9. Press the ACTION button twice to exit the Manual Programming Menu.

Set-up Features (cont.)

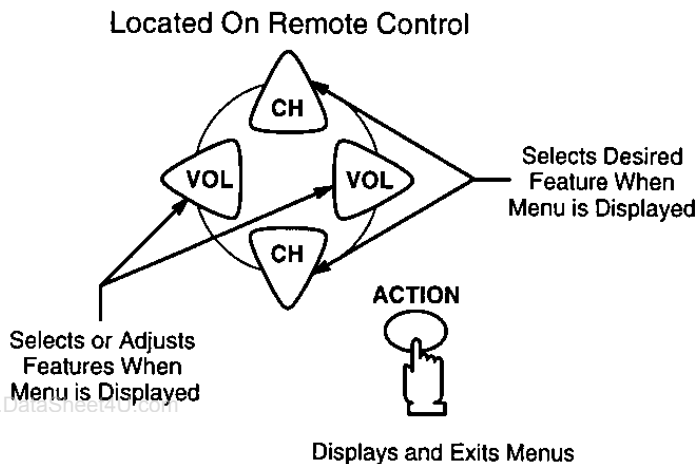

CC (Closed Caption) On Mute

Activates the On Screen Closed Captioning when the MUTE button on the Remote Control is pressed. To deactivate press the MUTE button again.

NOTE: This feature only functions when the Close Caption Mode is in the "OFF" position. The program being viewed must be broadcast with Closed Caption. (Refer to your local TV guide.)

1. Press the ACTION button to display the Main Menu.
2. Press the CH DOWN and VOL RIGHT buttons to select the Set-Up Icon.
3. Press the ACTION button to display the Set-Up Menu.

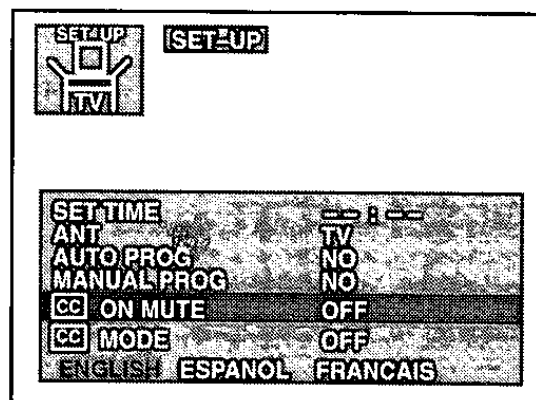

4. Press the CH DOWN button to highlight "CC ON MUTE".
5. Press the VOL RIGHT button to select OFF, C1 or C2 Mode.

Recommended Set-Up:

- Place CC ON MUTE into the C1 Mode.
- Press the CH DOWN button to select "CC MODE".
- Press the VOL RIGHT button to select "OFF".

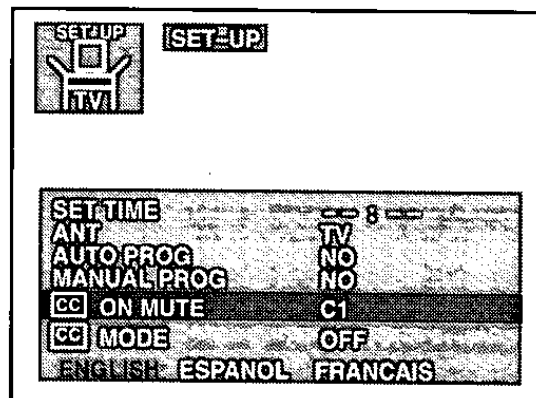

6. Press the ACTION button twice to exit the Set-Up Menu.
7. Press the MUTE button when the program being viewed is broadcast with Closed Caption to activate. Press again to deactivate.

Set-up Features (cont.)

Located On Remote Control

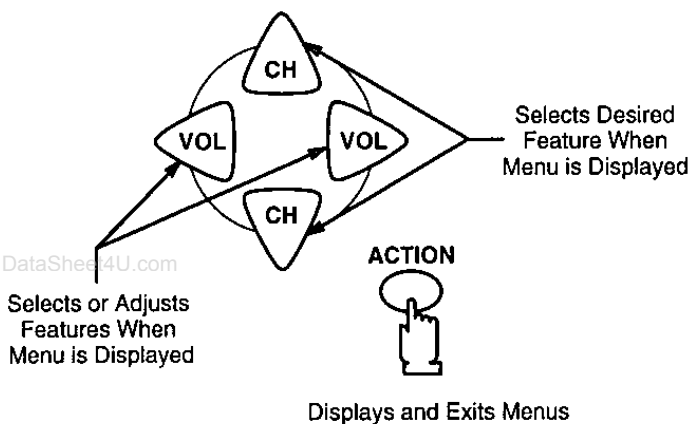

CC (Closed Caption) Mode

This Receiver has a built in decoder that provides a visual depiction of the audio portion of a television program in the form of written words across the screen (White or Colored letters on a black background). It allows the viewer to read the dialogue of a television program or other information.

1. Press the ACTION button to display the Main Menu.
2. Press the CH UP/DOWN and VOL LEFT/RIGHT buttons to select the Set-Up Icon.
3. Press the ACTION button to display the Set-Up Menu.

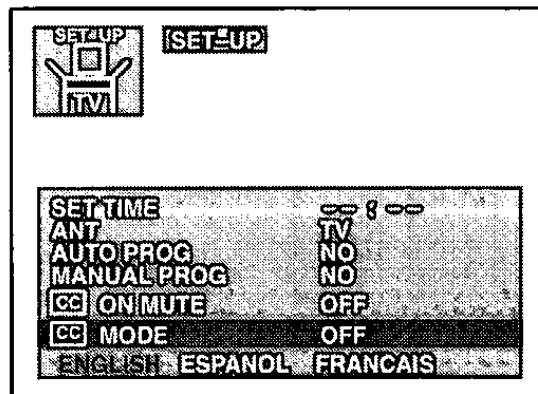

4. Press the CH DOWN button to highlight "CC MODE".
5. Press the VOL RIGHT button to select OFF, C1, or C2 .
 - OFF – Recommended mode when you do not wish to view Closed Caption.
 - C1 – For video related information that can be displayed (up to 4 lines of script strategically placed on the television screen so that it does not obstruct relevant parts of the picture). Script can be in any language.
 - C2 – Another mode used for video related information that can be displayed (up to 4 lines of script strategically placed on the television screen so that it does not obstruct relevant parts of the picture).
6. Press the ACTION button twice to exit the Set-Up Menu.

Set-up Features (cont.)

Located On Remote Control

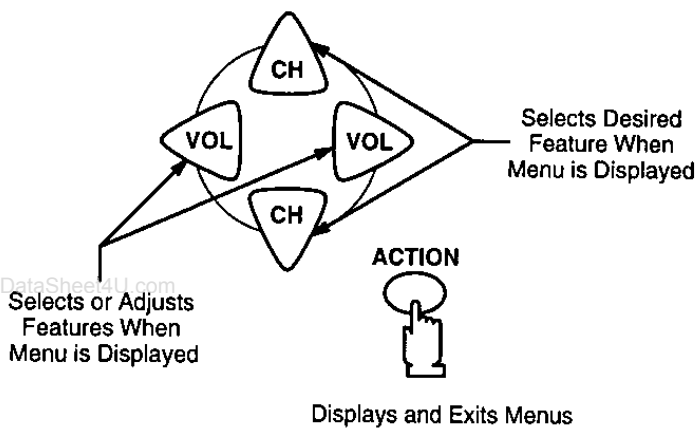

Trilingual Menu Selection

The Language Menu is factory set to ENGLISH. Follow these instructions to change the Language Menu to Spanish or French and back to English.

1. Press the ACTION button to display the Main Menu.
2. Press the CH UP/DOWN and VOL LEFT/RIGHT buttons to highlight the SET-UP Icon.
3. Press the ACTION button to display the Set-Up Menu.

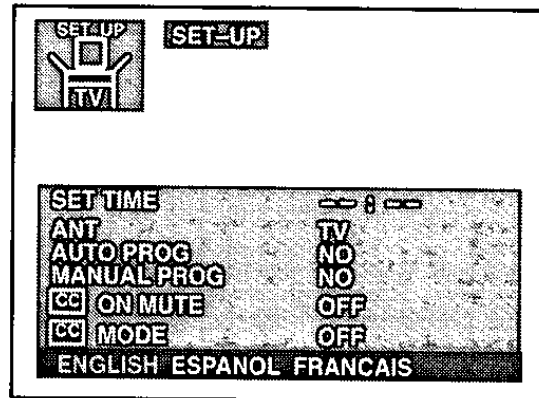

4. Press the CH UP or DOWN button to highlight "ENGLISH ESPAÑOL FRANCAIS."
5. Press the VOL LEFT or RIGHT button to select "ENGLISH", "ESPAÑOL" or "FRANCAIS".
6. Press the ACTION button twice to exit the Set-Up Menu.

Helpful Hints:

Language Menu does not affect Close Caption transmitted information.

Care and Cleaning

Picture Tube (Turn set off)

Use a mild soap solution or window cleaner and a clean cloth. DO NOT USE ABRASIVE CLEANERS. Avoid excessive moisture and wipe dry.

Plastic Cabinets

Wipe the cabinet with a soft cloth dampened with water or a mild detergent solution and wipe dry with a soft clean cloth. Avoid excessive moisture. Do not use benzene, thinners or other petroleum based cleaners.

Wood Cabinets

When dusting or polishing the cabinet, use a clean soft cloth and stroke straight with the grain. An occasional coat of furniture polish will help preserve the finish. Do not use benzene, thinners or other petroleum based cleaners. Do not place objects made of plastic or rubber directly on top of the cabinet. A chemical reaction could result causing permanent marring of the finish.

Remote Control Transmitter

Do not use benzene, thinners or other petroleum based cleaners to clean the Remote Control Transmitter. To clean, wipe with a soft cloth slightly moistened with a mild detergent and then wipe dry with a soft clean cloth.

















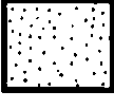

Power Loss

Prolonged power interruption causes the following features to reset to their factory preset state.

FEATURE	FACTORY PRESET STATE	FEATURE	FACTORY PRESET STATE
POWER	OFF	SLEEP TIMER	NO/OFF
VOLUME	APPROX.-1/3	TIMER	NO/OFF
CHANNEL	CH 03	ANTENNA MODE	CABLE
PROGRAM MEMORY	UNPROGRAMMED	TV/VIDEO	TV
VIDEO MENUS	NORMALIZED	TRILINGUAL MENU	ENGLISH
CLOCK	NOT SET		

Troubleshooting Chart

Before you call for service, determine the symptoms and make a few simple checks shown below.

Symptoms		Check
Picture	Sound	
 SNOWY PICTURE	 NOISY SOUND	<ul style="list-style-type: none"> - ANTENNA LOCATION AND/OR CONNECTION
 MULTIPLE IMAGE	 NORMAL SOUND	<ul style="list-style-type: none"> - ANTENNA DIRECTION AND/OR LOCATION - ANTENNA LEAD-IN WIRE
 INTERFERENCE	 NOISY SOUND	<ul style="list-style-type: none"> - ELECTRICAL APPLIANCES, LIGHTS, CARS AND TRUCKS - DIATHERMY AND OTHER MEDICAL EQUIPMENT
 NORMAL PICTURE	 NO SOUND	<ul style="list-style-type: none"> - VOLUME CONTROL SETTING - MUTE CONTROL (IF APPLICABLE) - TRY ANOTHER CHANNEL - TV SPEAKERS SWITCH (IF APPLICABLE) IN THE OFF POSITION
 NO VIDEO	 NOISY SOUND	<ul style="list-style-type: none"> - TV OR CABLE TUNING MODE SET TO PROPER SETTING - ANTENNA INPUT CORRECT (IF APPLICABLE)
 NO PICTURE	 NO SOUND	<ul style="list-style-type: none"> - CHECK THAT AC POWER LINE IS PLUGGED INTO AC OUTLET - BRIGHTNESS & AUDIO CONTROLS SET PROPERLY - TRY ANOTHER CHANNEL
 NO COLOR	 NORMAL SOUND	<ul style="list-style-type: none"> - COLOR CONTROL SETTINGS - TRY ANOTHER CHANNEL
 BLUE PICTURE	 NO SOUND	<ul style="list-style-type: none"> - RECEIVER IN VIDEO MODE WITH NO SIGNAL
 BLACK BOX IN PICTURE	 SOUND	<ul style="list-style-type: none"> - CC (CLOSED CAPTION) IN TEXT MODE - SELECT CAPTION OFF MODE TO ELIMINATE BLACK BOX

Should this unit turn ON momentarily and then turn OFF, or fail to operate, unplug the AC cord and contact your Authorized Servicer for repairs.

Panasonic Sales Company,
Division of Matsushita Electric
of Puerto Rico Inc. ("PSC")
Ave. 65 de Infanteria, Km 9.5
San Gabriel Industrial Park
Carolina, Puerto Rico 00985
Tel. (809) 750-4300
FAX. (809) 768-2910

Matsushita Consumer Electronics
Company, Division of Matsushita
Electric Corporation of America
One Panasonic Way
Secaucus, New Jersey 07094

Matsushita Electric of Canada Limited
5770 Ambler Drive
Mississauga, Ontario L4W 2T3
Canada