

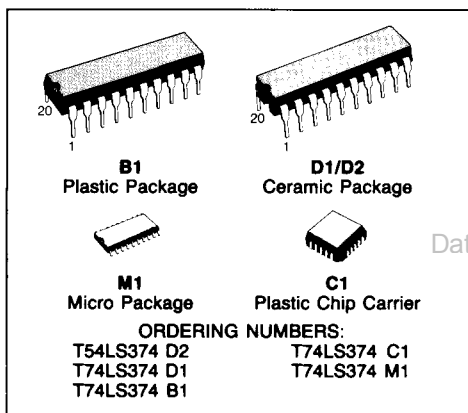

OCTAL D-TYPE FLIP-FLOP WITH 3-STATE OUTPUTS

DESCRIPTION

The T54LS374/T74LS374 is a high-speed, low-power Octal D-type Flip-Flop featuring separate D-type inputs for each flip-flop and 3-state outputs for oriented applications. A buffered Clock (CP) and Output Enable (\overline{OE}) are common to all flip-flops.



DataSheet

- EDGE-TRIGGERED D-TYPE INPUTS
- BUFFERED POSITIVE EDGE-TRIGGERED CLOCK
- 3-STATE OUTPUTS FOR BUS ORIENTED APPLICATIONS
- HYSTERESIS ON OUTPUT ENABLE INPUT TO IMPROVE NOISE MARGIN
- INPUT CLAMP DIODES LIMIT HIGH SPEED TERMINATION EFFECTS
- FULLY TTL AND CMOS COMPATIBLE

PIN CONNECTION (top view)

DUAL IN LINE

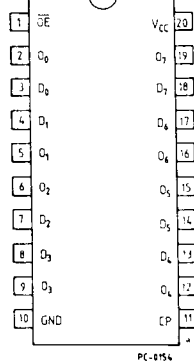

CHIP CARRIER

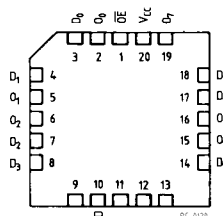

PIN NAMES

D_0 - D_7	Data Inputs
CP	Clock (Active HIGH Going Edge) Input
\overline{OE}	Output Enable (Active LOW) Input
O_0 - O_7	Outputs

NC = No Internal Connection



LOGIC SYMBOL AND LOGIC DIAGRAM

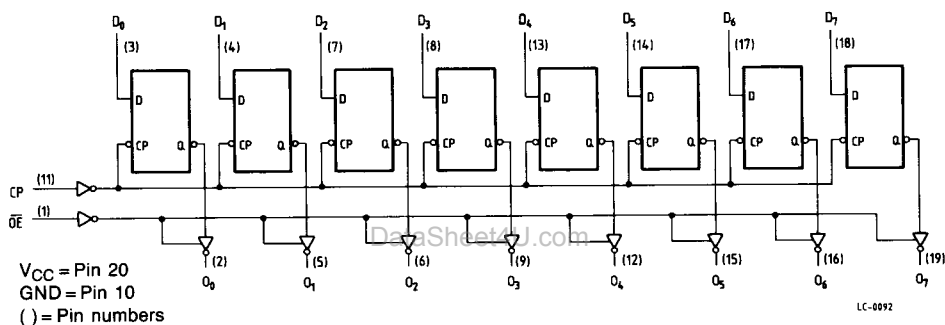
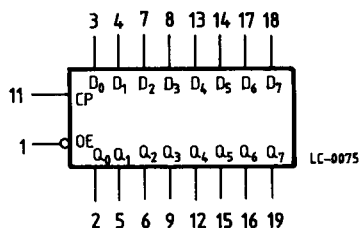

ABSOLUTE MAXIMUM RATINGS

Symbol	Parameter	Value	Unit
V_{CC}	Supply Voltage	-0.5 to 7	V
V_I	Input Voltage, Applied to Input	-0.5 to 15	V
V_O	Output Voltage, Applied to Output	-0.5 to 10	V
I_I	Input Current, Into Inputs	-30 to 5	mA
I_O	Output Current, Into Outputs	50	mA

Stresses in excess of those listed under "Absolute Maximum Ratings" may cause permanent damage to the device. This is a stress rating only and functional operation of the device at these or any other conditions in excess of those indicated in the operational sections of this specification is not implied. Exposure to absolute maximum rating conditions for extended periods may affect device reliability.

GUARANTEED OPERATING RANGES

Part Numbers	Supply Voltage			Temperature
	Min	Typ	Max	
T54LS374D2	4.5 V	5.0 V	5.5 V	-55°C to +125°C
T74LS374XX	4.75 V	5.0 V	5.25 V	0°C to +70°C

XX = package type.

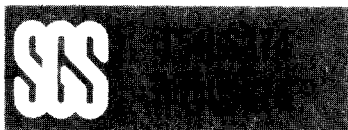

TRUTH TABLE

D _n	CP	\overline{OE}	Q _n
H	I	L	H
L	I	L	L
X	X	H	Z*

H = HIGH Voltage Level
 L = LOW Voltage Level
 X = Don't Care
 Z = HIGH Impedance

* Note: Contents of flip-flops unaffected by the state of the Output Enable input (\overline{OE})

FUNCTIONAL DESCRIPTION

The LS374 consist of eight edge-triggered flip-flops with individual D-type inputs and 3-state true outputs. The Clock and Output Enable are common. The eight flip-flops will store the state of their individual D inputs that meet the set-up and hold time requirements on the LOW-to-HIGH Clock (CP) tran-

sition. With the Output Enable (\overline{OE}) LOW, the contents of the eight flip-flops are reflected on the outputs. When the \overline{OE} is HIGH, the outputs go to the high impedance state. Operation of the OE input does not affect the state of the flip-flops

DC CHARACTERISTICS OVER OPERATING TEMPERATURE RANGE

Symbol	Parameter		Limits			Test Conditions (Note 1)		Units
			Min.	Typ.	Max.			
V _{IH}	Input HIGH Voltage		2.0			Guaranteed input HIGH Voltage for all Inputs		V
V _{IL}	Input LOW Voltage	54			0.7	Guaranteed input LOW Voltage for all Inputs		V
		74			0.8			
V _{CD}	Input Clamp Diode Voltage				-1.5	V _{CC} = MIN, I _{IN} = -18mA		V
V _{OH}	Output HIGH Voltage	54	2.4	3.4		I _{OH} = -1.0mA	V _{CC} = MIN, V _{IN} = V _{IH} or V _{IL} per Truth Table	V
		74	2.4	3.1		I _{OH} = -2.6mA		
V _{OL}	Output LOW Voltage	54,74		0.25	0.4	I _{OL} = 12mA	V _{CC} = MIN, V _{IN} = V _{IH} or V _{IL} per Truth Table	V
		74		0.35	0.5	I _{OL} = 24mA		
I _{OZH}	Output Off Current HIGH				20	V _{CC} = MAX, V _{OUT} = 2.7V, V _E = 2.0V		μA
I _{OZL}	Output Off Current LOW				-20	V _{CC} = MAX, V _{OUT} = 0.4V, V _E = 2.0V		μA
I _{IH}	Input HIGH Current				20	V _{CC} = MAX, V _{IN} = 2.7V		μA
	Input HIGH Current at MAX Input Voltage				0.1	V _{CC} = MAX, V _{IN} = 7.0V		mA
I _{IL}	Input LOW Current				-0.4	V _{CC} = MAX, V _{IN} = 0.4V		mA
I _{OS}	Output Short Circuit Current (Note 2)		-30		-130	V _{CC} = MAX, V _{OUT} = 0V		mA
I _{CC}	Power Supply Current Output Off			27	45	V _{CC} = MAX, V _{IN} = 0V, V _E = 4.5V		mA

Notes:

- 1) Conditions for testing, not shown in the Table, are chosen to guarantee operation under "worst case" conditions
- 2) Not more than one output should be shorted at a time.
- 3) Typical values are at V_{CC} = 5.0V, T_A = 25°C

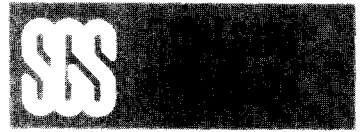
AC CHARACTERISTICS: $T_A = 25^\circ\text{C}$

Symbol	Parameter	Limits			Test Conditions		Units
		Min.	Typ.	Max.			
t_{PLH} t_{PHL}	Propagation Delay, CP to Output		15 19	28 28	Fig. 1	$C_L = 45\text{pF}$ $R_L = 667\Omega$	ns
t_{PZH}	Output Enable Time to HIGH level		20	28	Figs. 3, 4		ns
t_{PZL}	Output Enable Time to LOW level		21	28	Figs. 2, 4		ns
t_{PLZ}	Output Disable Time from LOW level		15	25	Figs. 2, 4	$C_L = 5.0\text{pF}$ $R_L = 667\Omega$	ns
t_{PHZ}	Output Disable Time from HIGH level		12	20	Figs. 3, 4		ns
f_{MAX}	Maximum Input Frequency	35	50		Fig. 1		MHz

DataSheet4U.com

AC SET-UP REQUIREMENTS: $T_A = 25^\circ\text{C}$

Symbol	Parameter	Limits			Test Conditions		Units
		Min.	Typ.	Max.			
t_{WCP}	Minimum Clock Pulse Width HIGH or LOW	13	10		Fig. 1	$V_{CC} = 5.0\text{V}$	ns
t_s	Minimum Set-up Time, Data to CP	20	15				ns
t_h	Minimum Hold Time, Data to CP	0	-3				ns

DEFINITION OF TERMS:

SET-UP TIME (t_s) - is defined as the minimum time required for the correct logic level to be present at the logic input prior to the clock transition from HIGH to LOW in order to be recognized and transferred to the outputs.

HOLD TIME (t_h) - is defined as the minimum time following the clock transition from LOW to HIGH that the logic level must be maintained at the input in order to ensure continued recognition. A negative HOLD TIME indicates that the correct logic level may be released prior to the clock transition from LOW to HIGH and still be recognized.

AC WAVEFORMS AND LOAD CIRCUIT

Fig. 1

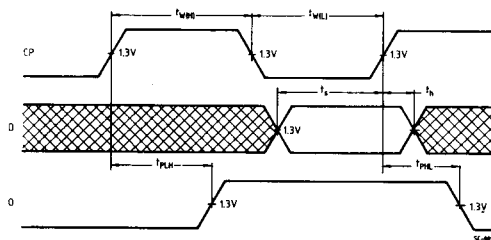

Fig. 2

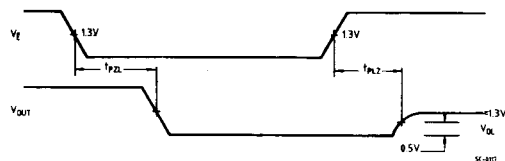
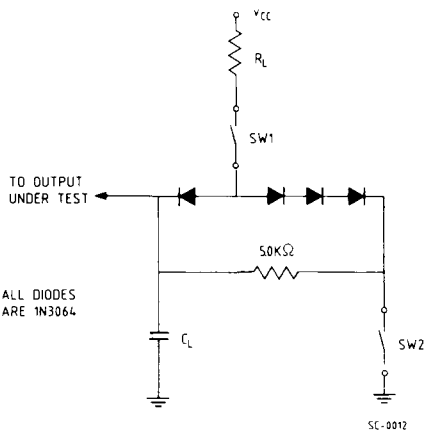

Fig. 3



Fig. 4



SWITCH POSITION

Symbol	SW1	SW2
t_{PH}	Open	Closed
t_{PL}	Closed	Open
t_{PHZ}	Closed	Closed
t_{PLZ}	Closed	Closed