

SEMI 4200 150NSEC, STATIC, TTL IN/OUT, 4096x1 N-MOS RAM

FEATURES

- Completely Static
- Access Time as low as 150 nsec max
- Cycle Time as low as 300 nsec max
- Typical Operating Power Under 450 mw.
- Typical Standby Power Under 35 mw.
- Data Retention with Low V_{DD}
- Pin and Voltage Compatible with Standard 22 Pin 4K Dynamic Rams
- TTL Compatible Three-State Outputs
- Fully Decoded
- Active Low Chip Select

GENERAL DESCRIPTION

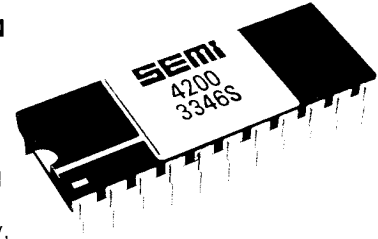

The SEMI 4200 is an N-Channel MOS Random Access Memory, organized as 4096 words by one bit. It uses a fully static memory cell which eliminates the need for any refresh or charge pump circuitry. All inputs can be driven by standard TTL devices and the three-state data output can directly drive one TTL load of any type. The \overline{CS} input provides for simple memory expansion and low system power, by putting unselected devices into a high output impedance and low power state. For additional power savings V_{DD} can be reduced significantly, thus allowing data to be retained economically under battery power.

BLOCK DIAGRAM

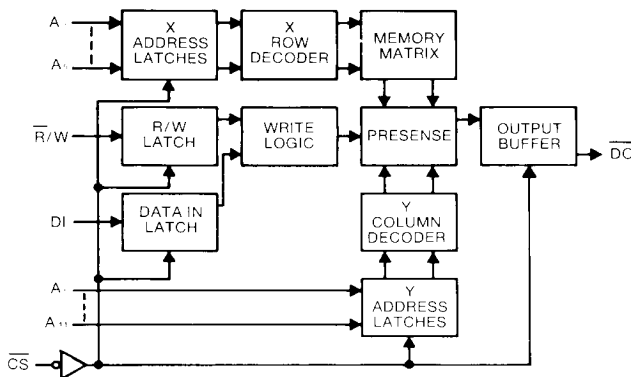

PIN CONFIGURATION

- A_N Address Inputs
- \overline{DI} Data Input
- \overline{DO} Data Output
- \overline{CS} Chip Select Input
- $\overline{R/W}$ Read/Write Input
- N/C No Internal Connection
- V_{SS} Ground
- V_{BB} Supply Voltage (-5V)
- V_{CC} Supply Voltage (+5V)
- V_{DD} Supply Voltage (+12V)

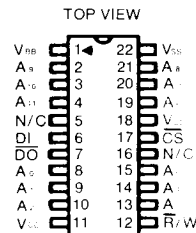

EMM SEMI 4200 150NSEC, STATIC, TTL IN/OUT, 4096x1 N-MOS RAM

RECOMMENDED OPERATING CONDITIONS T_{AMB} 0°C to 70°C

PARAMETER	SYMBOL	MIN	NOM	MAX	UNIT
Supply Voltage	V _{DD}	11.4	12.0	12.6	V _{DC}
Output Reference Voltage	V _{CC}	4.75	5.0	5.25	V _{DC}
Substrate Voltage	V _{BB}	4.5	-5	-5.5	V _{DC}
Input High Level	V _{IH}	2.4	-	5.25	V _{DC}
Input Low Level	V _{IL}	-0.1	-	0.7	V _{DC}
Chip Select High Level	V _{CH}	8	12	15	V _{DC}
Chip Select Low Level	V _{CL}	-1	-	0.5	V _{DC}

DC ELECTRICAL CHARACTERISTICS (Full Operating Voltage and Temperature Range Unless Otherwise Noted)

CHARACTERISTICS	SYMBOL	4200A		4200B		UNIT	CONDITIONS
		MIN	MAX	MIN	MAX		
Input Current	I _{IN}	-20	20	-20	20	μA	V _{IN} = 0.7V or 5V
Chip Select Input Current	I _{CS}	-20	20	-20	20	μA	V _{CS} = 0.5V or 12V
Output "Low" Voltage	V _{OL}	-	0.5	-	0.5	V _{DC}	I _{OL} = 2.0mA Fig. 5
Output "High" Voltage	V _{OH}	2.7	V _{CC}	2.7	V _{CC}	V _{DC}	I _{OH} = 500 μA Fig. 5
Output Current (Unselected)	I _{OO}	-20	20	-20	20	μA	V _{OL} = 2.7V, V _{CS} = 12V
Supply Current (Selected and Averaged Over One Cycle)	I _{DD}	-	50	-	55	mA	T _{AMB} = 25°C
		4200A	4200B				V _{DD} = 12V
T _{CSW}		200	150				V _{CC} = 5V
T _C		350	300				V _{BB} = 5V
For Other Conditions See Figure 3							V _{CS} = 12V
Supply Current (Unselected)	T _{AMB} = 25°C I _{DD}	-	5	-	5	mA	V _{DD} = 12V
	T _{AMB} = 70°C I _{DD}	-	15	-	15	mA	V _{CC} = 5V
Substrate Current	I _{BB}	-	-3	-	-3	mA	V _{BB} = -5V
Reference Supply Current	I _{CC}	-	100	-	100	μA	V _{CS} = 12V
Standby Current At Reduced Voltages	T _{AMB} = 25°C I _{DDS}	-	2	-	2	mA	V _{CS} = 4V to 15V
	T _{AMB} = 70°C I _{DDS}	-	6	-	6	mA	V _{DD} = 4V V _{BB} = -4V V _{CC} = 0V

READ CYCLE — AC CHARACTERISTICS

CHARACTERISTICS	SYMBOL	4200A		4200B		UNIT	CONDITIONS
		MIN	MAX	MIN	MAX		
Chip Select Read Pulse Width	T _{CSR}	200	-	150	-	ns	FULL OPERATING VOLTAGE AND TEMPERATURE RANGE
Chip Select Rise and Fall Time*	T _{CR} , T _{CF}	-	100	-	100	ns	
Set Up Time	T _P	0	-	0	-	ns	
Access Time	T _A	-	200	-	150	ns	
Cycle Time, T _{CR} = T _{CF} = 10ns	T _C	350	-	300	-	ns	
Data Hold Time	T _H	100	-	100	-	ns	
Output Recovery Time	T _{OR}	10	-	10	-	ns	
Read Recovery Time	T _{ORR}	125	-	125	-	ns	

WRITE CYCLE — AC CHARACTERISTICS

CHARACTERISTICS	SYMBOL	4200A		4200B		UNIT	CONDITIONS
		MIN	MAX	MIN	MAX		
Chip Select Write Pulse Width	T _{CSW}	200	-	150	-	ns	FULL OPERATING VOLTAGE AND TEMPERATURE RANGE
Chip Select Rise and Fall Time*	T _{CR} , T _{CF}	-	100	-	100	ns	
Set Up Time	T _P	0	-	0	-	ns	
Cycle Time, T _{CR} = T _{CF} = 10ns	T _C	350	-	300	-	ns	
Data Hold Time	T _H	100	-	100	-	ns	
Write Recovery Time	T _{OWR}	125	-	125	-	ns	

*Typical Chip Select Rise and Fall Time (T_{CR} and T_{CF}) is 10 ns For Read and Write Cycle

CAPACITANCE (Over Full Temperature Range and Worst Case Voltage Conditions)

CHARACTERISTICS	SYMBOL	MIN	TYP	MAX	UNIT	CONDITIONS
Input Capacitance (Except Chip Select)	C _{IN}	-	4	6	pF	V _{IN} = 2.4V
Input Capacitance Chip Select	C _{CS}	-	6	10	pF	V _{CS} = 12V or 0V
Output Capacitance	C _O	-	6	8	pF	V _O = 2.7V V _{CS} = 12V



A Subsidiary of Electronic Memories & Magnetics Corporation • 3883 North 28th Avenue, Phoenix, Arizona 85017 • (602) 263-0202

ABSOLUTE MAXIMUM RATINGS (See Note 1) (Referenced to GND)

RATING	SYMBOL	VALUE	UNIT
Supply Voltages	V _{DD}	-.5 to +18	V _{dc}
	V _{CC}	.5 to +7	V _{dc}
	V _{BB}	-.5 to -18	V _{dc}
Input & Output Voltages (Except Chip Select)	V _I , V _O	V _{BB} to +15	V _{dc}
Chip Select Input Voltage	V _{CS}	V _{BB} to +15	V _{dc}
Power Dissipation	P _D	1.6 (Note 2)	W
Operating Ambient Temperature Range	T _{AMB}	0 to +70	°C
Storage Temperature Range		-65 to +150	°C

This device contains circuitry to protect the inputs against damage due to high static voltages or electric fields; however, it is advised that normal precautions be taken to avoid application of any voltage higher than maximum rated voltages to this high impedance circuit.

NOTE 1: Permanent device damage may occur if ABSOLUTE MAXIMUM RATINGS are exceeded. Functional operation should be restricted to RECOMMENDED OPERATING CONDITIONS. Exposure to higher than recommended or maximum voltages for extended periods of time could affect device reliability.

NOTE 2: At 25°C ambient. Derate 13.5mw/°C.

Figure 1 – READ CYCLE

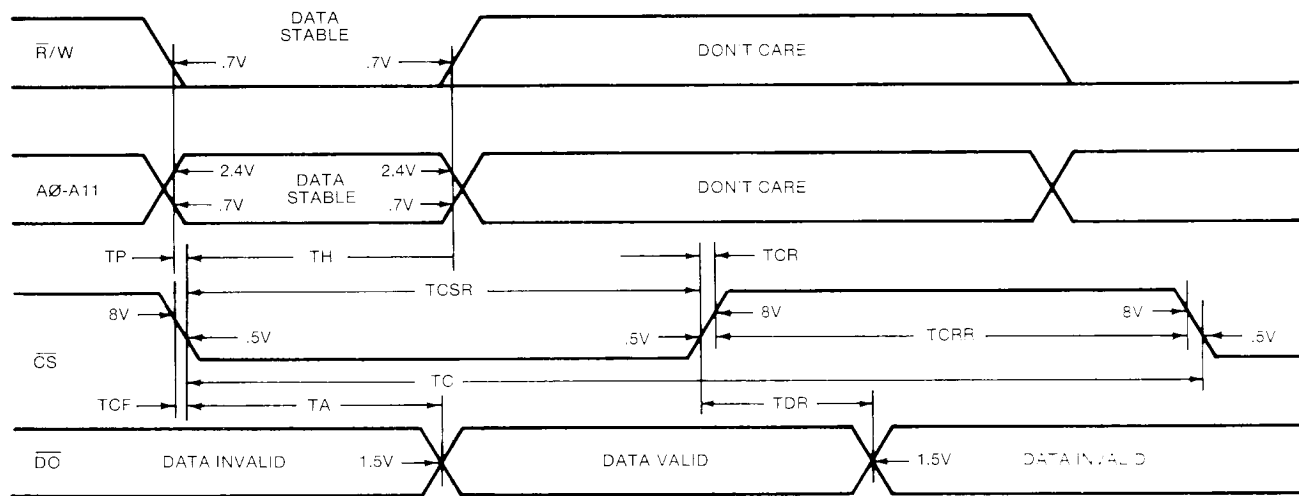
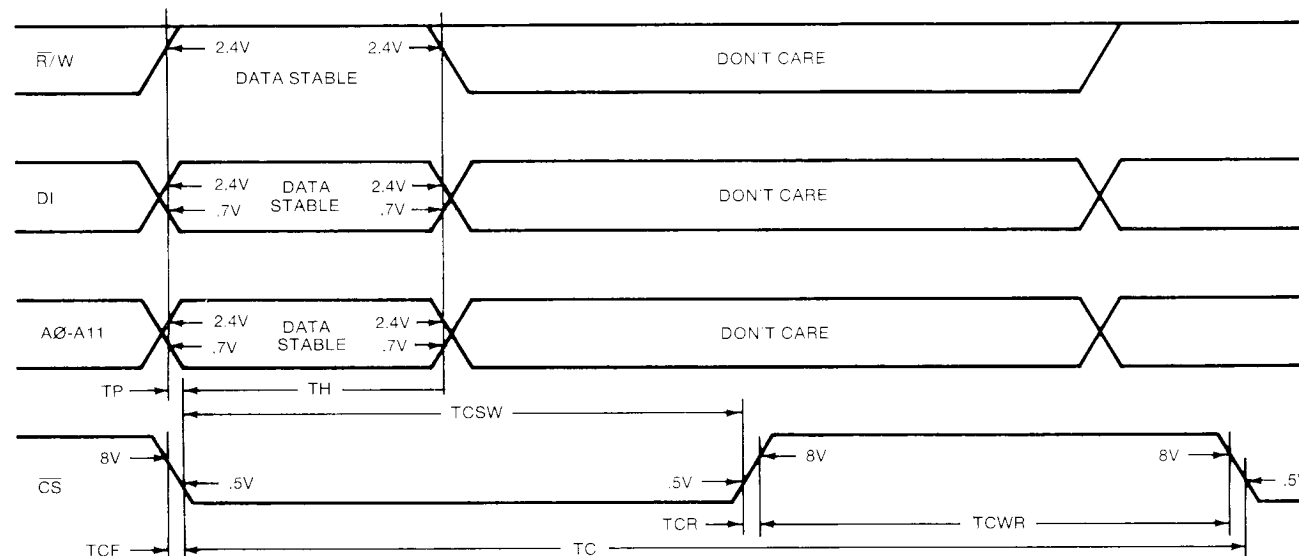

Figure 2 – WRITE CYCLE



EMM SEMI 4200 150NSEC, STATIC, TTL IN/OUT, 4096x1 N-MOS RAM

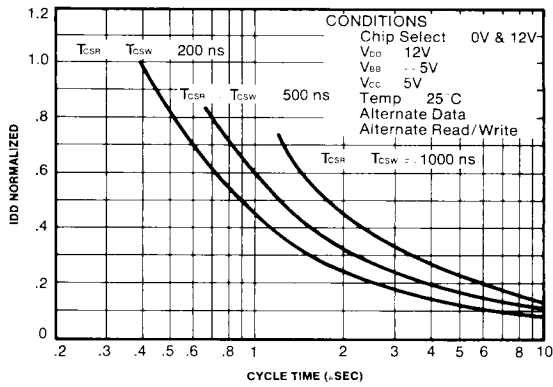

Figure 3. OPERATING IDD AS A FUNCTION OF CYCLE TIME

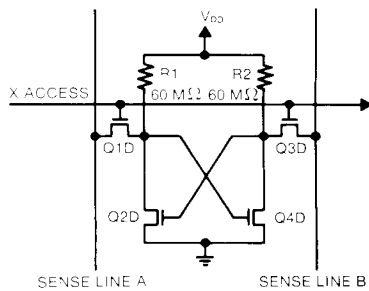
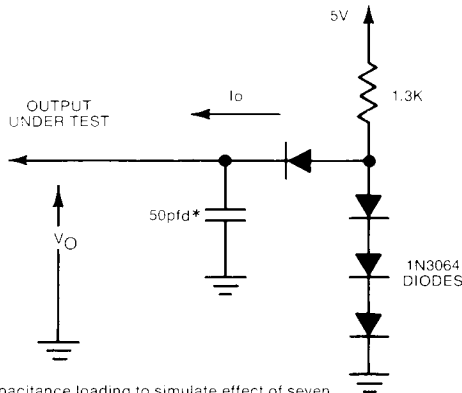

Figure 4. MEMORY CELL



*Capacitance loading to simulate effect of seven additional outputs plus one TTL input

Figure 5. OUTPUT TEST LOAD

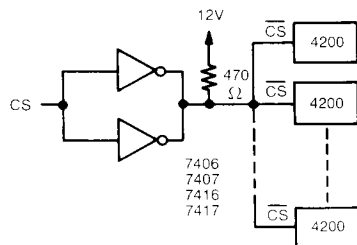

Figure 6. TYPICAL CHIP SELECT DRIVER

FUNCTIONAL DESCRIPTION

EMM/SEMI 4200 is a 4096 bit static RAM with memory cells organized in an array of 64 rows by 64 columns (4096 words x 1 bit). Each memory cell is addressed by simultaneously decoding the X addresses (A_0 through A_5) for the rows and the Y addresses (A_6 through A_{11}) for the columns. Data is written or read on separate input (\overline{DI}) and output (\overline{DO}) pins. Logic level 1 is represented by a high state on pin \overline{DI} but is represented on \overline{DO} by a low state. The operation of the memory is controlled by \overline{CS} and $\overline{R/W}$.

When \overline{CS} is high, all pins are in an inoperative high impedance state, and power is supplied only to the memory elements. When \overline{CS} is low, the memory is enabled for reading or writing.

The negative going edge of \overline{CS} begins timing for a read cycle. Data on $\overline{R/W}$ and address pins (A_N) must be stable for time T_H . $\overline{R/W}$ and A_N will then have been latched into D type flip flops and no longer need to be held stable. Output data will be presented on \overline{DO} within time T_A and will remain until time T_{DR} after \overline{CS} goes high. Data will then be invalid. After time T_C another read or write cycle can be initiated.

The negative going edge of \overline{CS} also begins timing for a write cycle. $\overline{R/W}$, A_N and \overline{DI} must be held stable for time T_H . These inputs will then have been latched and \overline{DI} will be entered within time T_{CSW} . Another read or write cycle can be initiated after time T_C .

The memory cells (because they are cross coupled high impedance static cells) will retain data down to $V_{DD} = 4V$, $V_{BB} = -4V$.

CERAMIC PACKAGE DIMENSIONS

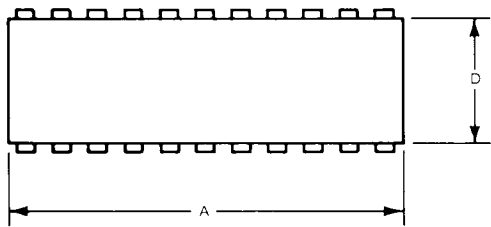

DIM	MILLIMETERS		INCHES	
	MIN	MAX	MIN	MAX
A	27.1	27.8	1.065	1.095
B	—	3.56	—	0.140
C	0.38	0.53	0.015	0.023
D	8.64	10.8	0.340	0.425
E	2.29	2.79	0.090	0.110
F	0.64	1.65	0.025	0.065
G	0.20	0.30	0.008	0.012
J	2.54	3.81	0.100	0.150
K	10.2 REF		0.4 REF	

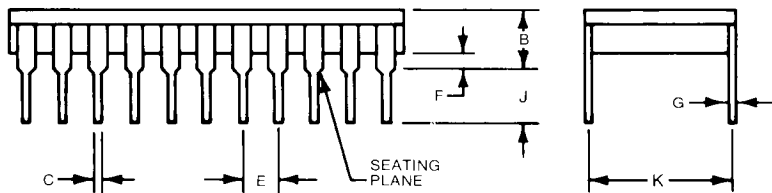

PLASTIC PACKAGE DIMENSIONS

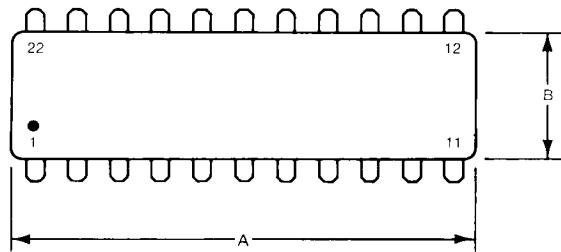

DIM	MILLIMETERS		INCHES	
	MIN	MAX	MIN	MAX
A	25.4	29.72	1.000	1.17
B	8.64	9.14	.340	.360
C	4.32	5.08	.170	.200
D	.36	.56	.014	.022
E	.76	1.52	.030	.060
F	2.41	2.67	.095	.105
G	1.02	2.03	.040	.080
H	.20	.31	0.08	.012
J	9.65	10.16	.380	.400
K	0	15	0	15
L	.51	1.02	.020	.040
M	2.54	3.56	.100	.140

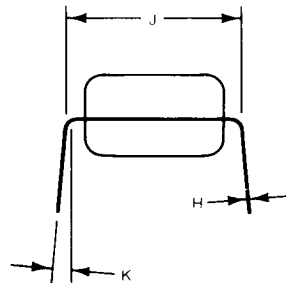
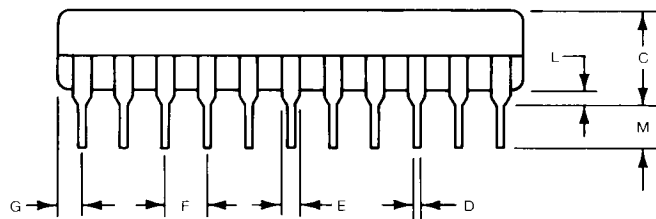

5

ORDERING INFORMATION

<u>Part Number</u>	<u>Access</u>	<u>Speed</u> <u>Cycle</u>	<u>Package</u>	<u>Temperature Range</u>
4200ACC	200	350	Ceramic	0°C to -70°C
4200ACP	200	350	Plastic	0°C to -70°C
4200BCC	150	300	Ceramic	0°C to -70°C
4200BCP	150	300	Plastic	0°C to -70°C

WARNING:

MOS CIRCUITS ARE SUBJECT TO DAMAGE FROM STATIC DISCHARGE

Internal static discharge circuits are provided to minimize part damage due to environmental static electrical charge build-ups. Industry established recommendations for handling MOS circuits include:

1. Ship and store product in conductive shipping tubes or in conductive foam plastic. Never ship or store product in non-conductive plastic containers or non-conductive plastic foam material.
2. Handle MOS parts only at conductive work stations.
3. Ground all assembly and repair tools.

Represented in Your Area By:



A Subsidiary of Electronic Memories & Magnetics Corporation
3883 North 28th Avenue, Phoenix, Arizona 85017
Telephone (602) 263-0202 • TWX 910-951-1383

JUL 31 1991
020403