

Sensitivity Easily Adjusted with Teaching

- Four Amplifiers built into Four-channel Fiber Amplifier Models.
- Four Fiber Units can be wired close together and connected to a Four-channel Fiber Amplifier without mutual interference.
- Compact with a width of 32 mm (Four-channel Fiber Amplifier Models) and a width of 10 mm (One-channel Fiber Amplifier Models).
- Built-in initial operating level compensation function allows no-object teaching.



Ordering Information

■ Amplifier Units

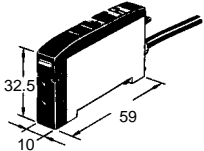
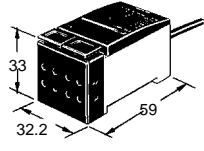
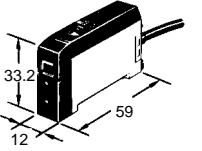
Item	General-purpose	Multi-function	Four-channel	Waterproof red light source	Waterproof green light source
Model	E3X-NT11 (NPN output) E3X-NT41 (PNP output)	E3X-NT21 (NPN output) E3X-NT51 (PNP output)	E3X-NM11 (NPN output) E3X-NM41 (PNP output)	E3X-NV21 (NPN output)	E3X-NVG21 (NPN output)
Appearance					
Light source	Red LED ($\lambda = 680 \text{ nm}$)				Green LED ($\lambda = 565 \text{ nm}$)
Power supply voltage	12 to 24 VDC $\pm 10\%$, ripple (p-p) 10% max.				
Current consumption	50 mA max.		150 mA max.	50 mA max.	
Response time	500 μs max. at rated sensing distance				
Control output	PNP or NPN open collector, load current: 100 mA, residual voltage: 1 V max.				
Timer function (see note)	---	OFF-delay timer (fixed to 40 ms)	OFF-delay timer (fixed to 40 ms) (independent channel)	OFF-delay timer (fixed to 40 ms)	
Teaching confirmation function	Indicator (red/green LEDs) and buzzer				
Remote teaching input	---	Pink and blue (0 V) wires are short-circuited when remote input is ON. (0 V short-circuit current: 1 mA max.) Pink and blue (0 V) wires are not short-circuited when remote input is OFF. (Open or 9 V min.; max. input voltage: 24 V) Response time is 0.5 ms max. when remote input is OFF.		Blue and pink wires are short-circuited when remote input is ON. Blue and pink wires are not short-circuited when remote input is OFF.	
Output	Light ON and Dark ON switch selectable				







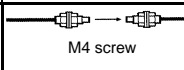
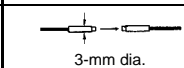

Note: It is possible to disable the OFF-delay timer function by using the switch setting.

■ Fiber Unit

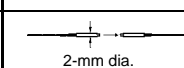

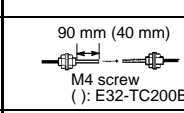
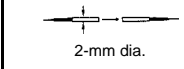
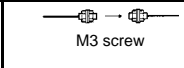
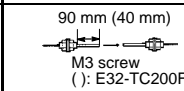
Indicates models that allow free cutting. Models without this mark do not allow free cutting.

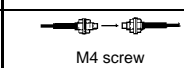
Through-beam (Separate) Sensors

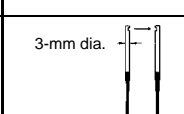
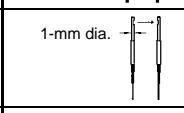
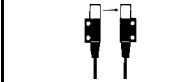
Model	Appearance	Sensing distance (standard object: opaque) (NT: E3X-NT□□□; NM: E3X-NM□□□ NV: E3X-NV21; NVG: E3X-NVG21)	Min. sensing object (opaque objects)	Features
E32-T11L	 M4 screw	NT: 540 mm (1,280 mm ^{*1}) (1.4-mm dia. min.) NM: 500 mm (1,200 mm ^{*1}) (1.4-mm dia. min.) NV: 540 mm (1,280 mm ^{*1}) (1.4-mm dia. min.) NVG: 40 mm (120 mm ^{*1}) (1.4-mm dia. min.)	NT: 0.15-mm dia. NM: 0.2-mm dia. NV: 0.15-mm dia. NVG: 0.5-mm dia.	Long distance
E32-T12L	 3-mm dia.	NT: 540 mm (1.4-mm dia. min.) NM: 500 mm (1.4-mm dia. min.) NV: 540 mm (1.4-mm dia. min.) NVG: 40 mm (1.4-mm dia. min.)	NT: 0.15-mm dia. NM: 0.2-mm dia. NV: 0.15-mm dia. NVG: 0.5-mm dia.	Long distance
E32-T21L	 M3 screw	NT: 160 mm (0.9-mm dia. min.) NM: 150 mm (0.9-mm dia. min.) NV: 160 mm (0.9-mm dia. min.) NVG: 10 mm (0.9-mm dia. min.)	NT: 0.1-mm dia. NM: 0.2-mm dia. NV: 0.1-mm dia. NVG: 0.2-mm dia.	Long distance with thin fiber
E32-T22L	 2-mm dia.	NT: 160 mm (0.9-mm dia. min.) NM: 150 mm (0.9-mm dia. min.) NV: 160 mm (0.9-mm dia. min.) NVG: 10 mm (0.9-mm dia. min.)	NT: 0.1-mm dia. NM: 0.2-mm dia. NV: 0.1-mm dia. NVG: 0.2-mm dia.	Long distance with thin fiber
E32-TC200	 M4 screw	NT: 290 mm (2,100 mm ^{*1}) (1-mm dia. min.) NM: 270 mm (2,000 mm ^{*1}) (1-mm dia. min.) NV: 290 mm (2,100 mm ^{*1}) (1-mm dia. min.) NVG: 28 mm (190 mm ^{*1}) (1-mm dia. min.)	NT: 0.1-mm dia. NM: 0.2-mm dia. NV: 0.1-mm dia. NVG: 0.2-mm dia.	General-purpose
E32-TC200B E32-TC200B4	 90 mm (40 mm) M4 screw (): E32-TC200B4	NT: 290 mm (1-mm dia. min.) NM: 270 mm (1-mm dia. min.) NV: 290 mm (1-mm dia. min.) NVG: 28 mm (1-mm dia. min.)	NT: 0.1-mm dia. NM: 0.2-mm dia. NV: 0.1-mm dia. NVG: 0.2-mm dia.	General-purpose
E32-T22	 2-mm dia.	NT: 75 mm (0.5-mm dia. min.) NM: 70 mm (0.5-mm dia. min.) NV: 75 mm (0.5-mm dia. min.) NVG: 7 mm (0.5-mm dia. min.)	NT: 0.1-mm dia. NM: 0.2-mm dia. NV: 0.1-mm dia. NVG: 0.1-mm dia.	General-purpose
E32-TC200E	 M3 screw	NT: 75 mm (0.5-mm dia. min.) NM: 70 mm (0.5-mm dia. min.) NV: 75 mm (0.5-mm dia. min.) NVG: 8 mm (0.5-mm dia. min.)	NT: 0.1-mm dia. NM: 0.2-mm dia. NV: 0.1-mm dia. NVG: 0.1-mm dia.	General-purpose
E32-TC200F E32-TC200F4	 90 mm (40 mm) M3 screw (): E32-TC200F4	NT: 75 mm (0.5-mm dia. min.) NM: 70 mm (0.5-mm dia. min.) NV: 75 mm (0.5-mm dia. min.) NVG: 8 mm (0.5-mm dia. min.)	NT: 0.1-mm dia. NM: 0.2-mm dia. NV: 0.1-mm dia. NVG: 0.1-mm dia.	General-purpose
E32-TC200A	 M3 screw	NT: 270 mm (1-mm dia. min.) NM: 250 mm (1-mm dia. min.) NV: 270 mm (1-mm dia. min.) NVG: 28 mm (1-mm dia. min.)	NT: 0.1-mm dia. NM: 0.2-mm dia. NV: 0.1-mm dia. NVG: 0.2-mm dia.	General-purpose
E32-T11	 M4 screw	NT: 260 mm (1,400 mm ^{*1}) (1-mm dia. min.) NM: 240 mm (1,300 mm ^{*1}) (1-mm dia. min.) NV: 260 mm (1,400 mm ^{*1}) (1-mm dia. min.) NVG: 10 mm (120 mm ^{*1}) (1-mm dia. min.)	NT: 0.1-mm dia. NM: 0.2-mm dia. NV: 0.1-mm dia. NVG: 0.2-mm dia.	Flexible (resists breaking)
E32-T21	 M3 screw	NT: 70 mm (0.5-mm dia. min.) NM: 65 mm (0.5-mm dia. min.) NV: 70 mm (0.5-mm dia. min.) NVG: 6 mm (0.5-mm dia. min.)	NT: 0.1-mm dia. NM: 0.2-mm dia. NV: 0.1-mm dia. NVG: 0.1-mm dia.	Flexible (resists breaking)
E32-T14L	 3-mm dia.	NT: 140 mm (1-mm dia. min.) NM: 130 mm (1-mm dia. min.) NV: 140 mm (1-mm dia. min.) NVG: 10 mm (1-mm dia. min.)	NT: 0.2-mm dia. NM: 0.3-mm dia. NV: 0.2-mm dia. NVG: 0.1-mm dia.	Side-view; long distance
E32-T24	 1-mm dia.	NT: 48 mm (0.5-mm dia. min.) NM: 45 mm (0.5-mm dia. min.) NV: 48 mm (0.5-mm dia. min.) NVG: 2 mm (0.5-mm dia. min.)	NT: 0.1-mm dia. NM: 0.2-mm dia. NV: 0.1-mm dia. NVG: 0.2-mm dia.	Side-view; space saving
E32-T14		NT: 1,070 mm (4-mm dia. min.) NM: 1,000 mm (4-mm dia. min.) NV: 1,070 mm (4-mm dia. min.) NVG: 80 mm (4-mm dia. min.)	NT: 0.2-mm dia. NM: 0.2-mm dia. NV: 0.2-mm dia. NVG: 0.2-mm dia.	Side-view; screw tightening type

*1 Values in parentheses are for cases where the E39-F1 Lens Unit is used.



Indicates models that allow free cutting. Models without this mark do not allow free cutting.

Model	Appearance	Sensing distance (standard object: opaque) (NT: E3X-NT□□; NM: E3X-NM□□ NV: E3X-NV21; NVG: E3X-NVG21)			Min. sensing object (opaque objects)	Features
		NT	NM	NV		
E32-T17L	M4 screw	7,500 mm (10-mm dia. min.)	7,000 mm (10-mm dia. min.)	7,500 mm (10-mm dia. min.)	NT: 0.5-mm dia. NM: 0.7-mm dia. NV: 0.5-mm dia. NVG: 2.1-mm dia.	Through-beam with lens, for ideal explosion-proof applications
E32-T12F	5-mm dia.	1,070 mm (4-mm dia. min.)	1,000 mm (4-mm dia. min.)	1,070 mm (4-mm dia. min.)	NT: 0.3-mm dia. NM: 0.3-mm dia. NV: 0.3-mm dia. NVG: 0.6-mm dia.	Teflon-covered*2; withstands chemicals and harsh environments
E32-T14F	5-mm dia.	110 mm (3-mm dia. min.)	100 mm (3-mm dia. min.)		NT: 0.3-mm dia. NM: 0.3-mm dia.	Teflon covered*2; side-view; withstands chemicals and harsh environments
E32-M21	M3 screw	210 mm (2-mm dia. min.)	200 mm (2-mm dia. min.)	210 mm (2-mm dia. min.)	NT: 0.1-mm dia. NM: 0.2-mm dia. NV: 0.1-mm dia. NVG: 0.3-min. dia.	4-head; 4-point detection
E32-T51	M4 screw	320 mm (1.5-mm dia. min.)	300 mm (1.5-mm dia. min.)	320 mm (1.5-mm dia. min.)	NT: 0.3-mm dia. NM: 0.4-mm dia. NV: 0.3-mm dia. NVG: 1.0-min. dia.	Heat-resistive; resists 150°C
E32-T54	2-mm dia.	85 mm (1-mm dia. min.)	70 mm (1-mm dia. min.)		NT: 0.4-mm dia. NM: 0.4-mm dia.	Heat-resistive; side-view; resists 150°C
E32-T61	M4 screw	190 mm (2,100 mm*1) (1-mm dia. min.)	180 mm (2,000 mm*1) (1-mm dia. min.)	190 mm (2,100 mm*1) (1-mm dia. min.)	NT: 0.15-mm dia. NM: 0.2-mm dia. NV: 0.15-mm dia. NVG: 0.5-min. dia.	Heat-resistive; resists 300°C*3

*1 Values in parentheses are for cases where the E39-F1 Lens Unit is used. The operating ambient temperature is from -40°C to 200°C for the E39-F1 specifications.

*2 Teflon is a registered trademark of the Dupont Company and the Mitsui Dupont Chemical Company for their fluoride resin.

*3 The resistive temperature varies with the part of the Fiber Unit. For details, refer to *Dimensions*.







Indicates models that allow free cutting. Models without this mark do not allow free cutting.



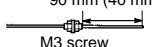







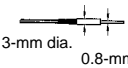







Reflective Sensors

Model	Appearance	Sensing distance (standard object: opaque) (NT: E3X-NT□□; NM: E3X-NM□□ NV: E3X-NV21; NVG: E3X-NVG21)			Min. sensing object (copper wire)	Features
		White paper	Black paper	Standard object		
E32-D11L	M6 screw	NT: 160 mm NM: 150 mm NV: 160 mm NVG: 10 mm	NT: 44 mm NM: 40 mm NV: 44 mm NVG: ---	NT: 20 x 20 cm NM: 20 x 20 cm NV: 20 x 20 cm NVG: 2.5 x 2.5 cm	NT: 0.012-mm dia. NM: 0.015-mm dia. NV: 0.012-mm dia. NVG: 3.0-mm dia.	Long distance
E32-D12	3-mm dia.	NT: 85 mm NM: 80 mm NV: 85 mm NVG: 2 mm	NT: 22 mm NM: 20 mm NV: 22 mm NVG: ---	NT: 10 x 10 cm NM: 10 x 10 cm NV: 10 x 10 cm NVG: 2.5 x 2.5 cm	NT: 0.012-mm dia. NM: 0.015-mm dia. NV: 0.012-mm dia. NVG: 1.6-mm dia.	Long distance
E32-D21L	M4 screw	NT: 38 mm NM: 35 mm NV: 38 mm NVG: 1 mm	NT: 10 mm NM: 9 mm NV: 10 mm NVG: ---	NT: 5 x 5 cm NM: 5 x 5 cm NV: 5 x 5 cm NVG: 2.5 x 2.5 cm	NT: 0.012-mm dia. NM: 0.015-mm dia. NV: 0.012-mm dia. NVG: 1.0-mm dia.	Long distance
E32-D22L	3-mm dia.	NT: 38 mm NM: 35 mm NV: 38 mm NVG: 1 mm	NT: 10 mm NM: 9 mm NV: 10 mm NVG: ---	NT: 5 x 5 cm NM: 5 x 5 cm NV: 5 x 5 cm NVG: 2.5 x 2.5 cm	NT: 0.012-mm dia. NM: 0.015-mm dia. NV: 0.012-mm dia. NVG: 1.0-mm dia.	Long distance
E32-DC200	M6 screw	NT: 110 mm NM: 100 mm NV: 110 mm NVG: 10 mm	NT: 22 mm NM: 20 mm NV: 22 mm NVG: ---	NT: 10 x 10 cm NM: 10 x 10 cm NV: 10 x 10 cm NVG: 2.5 x 2.5 cm	NT: 0.012-mm dia. NM: 0.015-mm dia. NV: 0.012-mm dia. NVG: 0.2-mm dia.	General-purpose
E32-DC200B E32-DC200B4	90 mm (40 mm) M6 screw (): E32-DC200B4	NT: 110 mm NM: 100 mm NV: 110 mm NVG: 10 mm	NT: 22 mm NM: 20 mm NV: 22 mm NVG: ---	NT: 10 x 10 cm NM: 10 x 10 cm NV: 10 x 10 cm NVG: 2.5 x 2.5 cm	NT: 0.012-mm dia. NM: 0.015-mm dia. NV: 0.012-mm dia. NVG: 1.0-mm dia.	General-purpose
E32-DC200E	M3 screw	NT: 22 mm NM: 20 mm NV: 22 mm NVG: 2 mm	NT: 5 mm NM: 4.8 mm NV: 5 mm NVG: ---	NT: 2.5 x 2.5 cm NM: 2.5 x 2.5 cm NV: 2.5 x 2.5 cm NVG: 2.5 x 2.5 cm	NT: 0.012-mm dia. NM: 0.015-mm dia. NV: 0.012-mm dia. NVG: 1.0-mm dia.	General-purpose

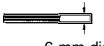
 Indicates models that allow free cutting. Models without this mark do not allow free cutting.

Model	Appearance	Sensing distance (standard object) (NT: E3X-NT□□; NM: E3X-NM□□ NV: E3X-NV21; NVG: E3X-NVG21)			Min. sensing object (copper wire)	Features
		White paper	Black paper	Standard object		
E32-DC200F E32-DC200F4 	90 mm (40 mm)  M3 screw (): E32-DC200F4	NT: 22 mm NM: 20 mm NV: 22 mm NVG: 2 mm	NT: 5 mm NM: 4.8 mm NV: 5 mm NVG: ---	NT: 2.5 x 2.5 cm NM: 2.5 x 2.5 cm NV: 2.5 x 2.5 cm NVG: 2.5 x 2.5 cm	NT: 0.012-mm dia. NM: 0.015-mm dia. NV: 0.012-mm dia. NVG: 1.0-mm dia.	General-purpose
E32-D11 	 M6 screw	NT: 65 mm NM: 60 mm NV: 65 mm NVG: 7 mm	NT: 14 mm NM: 13 mm NV: 14 mm NVG: ---	NT: 10 x 10 cm NM: 10 x 10 cm NV: 10 x 10 cm NVG: 2.5 x 2.5 cm	NT: 0.012-mm dia. NM: 0.015-mm dia. NV: 0.012-mm dia. NVG: 0.5-mm dia.	Flexible (resists breaking)
E32-D21 	 M3 screw	NT: 9 mm NM: 8 mm NV: 9 mm NVG: 1 mm	NT: 1.7 mm NM: 1.6 mm NV: 1.7 mm NVG: ---	NT: 2.5 x 2.5 cm NM: 2.5 x 2.5 cm NV: 2.5 x 2.5 cm NVG: 2.5 x 2.5 cm	NT: 0.012-mm dia. NM: 0.015-mm dia. NV: 0.012-mm dia. NVG: 1.0-mm dia.	Flexible (resists breaking)

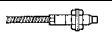
 Indicates models that allow free cutting. Models without this mark do not allow free cutting.

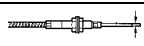
Model	Appearance	Sensing distance (standard object) (NT: E3X-NT□□; NM: E3X-NM□□ NV: E3X-NV21; NVG: E3X-NVG21)			Min. sensing object (copper wire)	Features
		White paper	Black paper	Standard object		
E32-D33 	 3-mm dia. 0.8-mm dia.	NT: 7 mm NM: 6 mm NV: 7 mm	NT: 1.4 mm NM: 1.3 mm NV: 1.4 mm	2.5 x 2.5 cm	NT: 0.012-mm dia. NM: 0.015-mm dia. NV: 0.012-mm dia.	Super-thin; minute object detection
E32-CC200 	 M6 screw	NT: 110 mm NM: 100 mm NV: 110 mm NVG: 10 mm	NT: 22 mm NM: 20 mm NV: 22 mm NVG: 2 mm	NT: 10 x 10 cm NM: 10 x 10 cm NV: 10 x 10 cm NVG: 2.5 x 2.5 cm	NT: 0.012-mm dia. NM: 0.015-mm dia. NV: 0.012-mm dia. NVG: 0.5-mm dia.	Coaxial; positioning accuracy
E32-D32 	 2-mm dia.	NT: 33 mm NM: 30 mm NV: 33 mm NVG: 2.5 mm	NT: 5.8 mm NM: 5.3 mm NV: 11 mm NVG: ---	2.5 x 2.5 cm	NT: 0.012-mm dia. NM: 0.015-mm dia. NV: 0.012-mm dia. NVG: 0.5-mm dia.	
E32-D32L 	 3-mm dia.	NT: 65 mm NM: 60 mm NV: 65 mm NVG: 4 mm	NT: 11 mm NM: 10 mm NV: 11 mm NVG: ---	NT: 10 x 10 cm NM: 10 x 10 cm NV: 10 x 10 cm NVG: 2.5 x 2.5 cm	NT: 0.012-mm dia. NM: 0.015-mm dia. NV: 0.012-mm dia. NVG: 1-mm dia.	
E32-D14L 	6-mm dia. 	NT: 44 mm NM: 40 mm NV: 44 mm NVG: 1.5 mm	NT: 8.8 mm NM: 8 mm NV: 8.8 mm NVG: ---	NT: 5 x 5 cm NM: 5 x 5 cm NV: 5 x 5 cm NVG: 2.5 x 2.5 cm	NT: 0.015-mm dia. NM: 0.03-mm dia. NV: 0.015-mm dia. NVG: 1.0-mm dia.	Side-view; long distance
E32-D24 	 2-mm dia.	NT: 17 mm NM: 15 mm NV: 17 mm NVG: 1.6 mm	NT: 2.8 mm NM: 2.5 mm NV: 2.8 mm NVG: ---	2.5 x 2.5 cm	NT: 0.012-mm dia. NM: 0.03-mm dia. NV: 0.012-mm dia. NVG: 1.0-mm dia.	Side-view; space saving
E32-D12F 	 6-mm dia.	NT: 55 mm NM: 50 mm NV: 55 mm NVG: 4 mm	NT: 16 mm NM: 15 mm NV: 16 mm NVG: ---	NT: 5 x 5 cm NM: 5 x 5 cm NV: 5 x 5 cm NVG: 2.5 x 2.5 cm	NT: 0.012-mm dia. NM: 0.03-mm dia. NV: 0.012-mm dia. NVG: 0.5-mm dia.	Teflon-covered* ¹ ; withstands chemicals and harsh environments
E32-D51 	 M6 screw	NT: 65 mm NM: 60 mm NV: 65 mm NVG: 5 mm	NT: 13 mm NM: 12 mm NV: 13 mm NVG: ---	NT: 10 x 10 cm NM: 10 x 10 cm NV: 10 x 10 cm NVG: 2.5 x 2.5 cm	NT: 0.012-mm dia. NM: 0.03-mm dia. NV: 0.012-mm dia. NVG: 1.0-mm dia.	Heat-resistant* ² ; resists 150°C
E32-D61 	 M6 screw	NT: 50 mm NM: 45 mm NV: 50 mm NVG: 5 mm	NT: 10 mm NM: 9 mm NV: 10 mm NVG: ---	NT: 5 x 5 cm NM: 5 x 5 cm NV: 5 x 5 cm NVG: 2.5 x 2.5 cm	NT: 0.012-mm dia. NM: 0.03-mm dia. NV: 0.012-mm dia. NVG: 1.0-mm dia.	Heat-resistant* ³ ; resists 300°C
E32-D73 	 M4 screw 1.25-mm dia.	NT: 33 mm NM: 30 mm NV: 33 mm NVG: 3 mm	NT: 6.6 mm NM: 6 mm NV: 6.6 mm NVG: ---	NT: 5 x 5 cm NM: 5 x 5 cm NV: 5 x 5 cm NVG: 2.5 x 2.5 cm	NT: 0.012-mm dia. NM: 0.03-mm dia. NV: 0.012-mm dia. NVG: 1.0-mm dia.	Heat-resistant* ³ ; resists 400°C









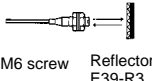

Note: The Sensor may be set to the light-ON state if the sensitivity (teaching) is set to maximum, in which case, use the Sensor at a sensitivity setting other than the maximum level.

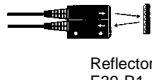
*1 Teflon is a registered trademark of the Dupont Company and the Mitsui Dupont Chemical Company for their fluoride resin.

*2 For continuous operation, use the products within the temperature ranging from -40°C to 130°C.

*3 The resistive temperature varies with the part of the Fiber Unit. For details, refer to *Dimensions*.

 Indicates models that allow free cutting. Models without this mark do not allow free cutting.

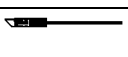
Model	Appearance	Sensing distance (standard object: opaque) (NT: E3X-NT□□; NM: E3X-NM□□ NV: E3X-NV21; NVG: E3X-NVG21)		Min. sensing object (copper wire)	Features
		White paper	Black paper		
E32-R21 +E39-R3*4 	 M6 screw Reflector E39-R3	NT: 25 to 250 mm (35-mm dia. min.)*1 NM: 25 to 250 mm (35-mm dia. min.)*1 NV: 25 to 250 mm (35-mm dia. min.)	---	NT: 0.3-mm dia. NM: 0.6-mm dia. NV: 0.3-mm dia.	Transparent objects detection Retroreflective (with M.S.R. function)*5
E32-R16 +E39-R1*4 	 Reflector E39-R1	NT: 150 to 1,500 mm (35-mm dia. min.)*1 NM: 150 to 1,500 mm (35-mm dia. min.)*1 NV: 150 to 1,500 mm (35-mm dia. min.)*1	---	NT: 0.5-mm dia. NM: 1.9-mm dia. NV: 0.5-mm dia.	Transparent objects detection
E32-L25*2 		NT: 3.3 mm (2.5 x 2.5 cm) NM: 3.3 mm (2.5 x 2.5 cm) NV: 3.3 mm (2.5 x 2.5 cm)	---	NT: 0.012-mm dia. NM: 0.015-mm dia. NV: 0.012-mm dia.	Limited reflective; detects wafers and small difference in height
E32-L25A*2 		NT: 3.3 mm (2.5 x 2.5 cm) NM: 3.3 mm (2.5 x 2.5 cm) NV: 3.3 mm (2.5 x 2.5 cm)*1	---	NT: 0.012-mm dia. NM: 0.015-mm dia. NV: 0.012-mm dia.	Limited reflective; detects wafers and small difference in height
E32-L25L*2,3 		NT: 7.2±1.8 mm (2.5 x 2.5 cm) NM: 7.2±1.8 mm (2.5 x 2.5 cm) NV: 7.2±1.8 mm (2.5 x 2.5 cm)*1	---	NT: 0.012-mm dia. NM: 0.015-mm dia. NV: 0.012-mm dia.	Limited reflective, long distance; detects wafers and small difference in height
E32-L24L*3 		NT: 4±2 mm (2.5 x 2.5 cm) NM: 4±2 mm (2.5 x 2.5 cm) NV: 4±2 mm (2.5 x 2.5 cm)	---	NT: 0.012-mm dia. NM: 0.015-mm dia. NV: 0.012-mm dia.	Limited reflective, long distance, side-view; detects wafers and small difference in height

*1 Standard object: opaque

*2 For standard sensing distances, refer to *Dimensions*.





*3 For continuous operation, use the products within the temperature ranging from -40°C to 90°C.

*4 The operating ambient temperature of the reflectors supplied with the product are the same as that for the E32-R21 and E32-R16.

*5 The M.S.R. (mirror surface rejection) function provides stable sensing for glossy objects.

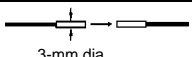

 Indicates models that allow free cutting. Models without this mark do not allow free cutting.

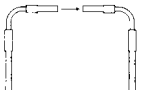
Fine Through-beam Sensors

Model	Appearance	Sensing distance (standard object: opaque) (NT: E3X-NT□□; NM: E3X-NM□□ NV: E3X-NV21; NVG: E3X-NVG21)	Min. sensing object (opaque objects)	Features
E32-T22S 	 3-mm dia.	NT: 650 mm (1.7-mm dia. min.) NM: 650 mm (1.7-mm dia. min.) NV: 650 mm (1.7-mm dia. min.)	NT: 0.2-mm dia. NM: 0.4-mm dia. NV: 0.2-mm dia.	General-purpose; detects wafers and small difference in height
E32-T24S 	 3.5 x 3 mm dia.	NT: 480 mm (2-mm dia. min.) NM: 450 mm (2-mm dia. min.) NV: 480 mm (2-mm dia. min.)	NT: 0.2-mm dia. NM: 0.4-mm dia. NV: 0.2-mm dia.	Side-view; detects wafers and small difference in height
E32-T84S 		NT: 480 mm (2-mm dia. min.) NM: 450 mm (2-mm dia. min.) NV: 480 mm (2-mm dia. min.)	NT: 0.3-mm dia. NM: 0.3-mm dia. NV: 0.3-mm dia.	L-shaped through-beam; heat resistance of up to 200°C.*

* The resistive temperature varies with the part of the Fiber Unit. For details, refer to *Dimensions*.

Slot Sensor

Model	Appearance	Sensing distance (standard object: opaque) (NT: E3X-NT□□; NM: E3X-NM□□ NV: E3X-NV21; NVG: E3X-NVG21)	Min. sensing object (opaque objects)	Features
E32-G14 		10 mm (slot width)*1 (4-mm dia. min.)	NT: 0.4-mm dia. NM: 0.7-mm dia. NV: 0.4-mm dia. NVG: 0.6-mm dia.	Slot through-beam; no optical axis adjustment required

*1 No-object teaching is not possible with the E32-G14 because the sensing distance of the E32-G14 is short and the light will be excessive. Perform with/without-object teaching instead.



Indicates models that allow free cutting. Models without this mark do not allow free cutting.

High-precision Screen Sensors

Model	Appearance	Slit width	Sensing distance (NT: E3X-NT□□□; NM: E3X-NM□□□ NV: E3X-NV21; NVG: E3X-NVGz1)	Min. sensing object*1 (horizontal beam)
E32-T16P		Not used	NT: 480 mm NM: 400 mm NV: 480 mm	NT: 1.3-mm dia. (0.6-mm dia.) NM: 1.0-mm dia. (0.7-mm dia.) NV: 1.3-mm dia. (0.6-mm dia.)
		0.5 mm wide	NT: 80 mm NM: 65 mm NV: 80 mm	NT: 1.3-mm dia. (0.4-mm dia.) NM: 1.0-mm dia. (0.4-mm dia.) NV: 1.3-mm dia. (0.4-mm dia.)
		1.0 mm wide	NT: 160 mm NM: 130 mm NV: 160 mm	NT: 1.3-mm dia. (0.5-mm dia.) NM: 1.0-mm dia. (0.6-mm dia.) NV: 1.3-mm dia. (0.5-mm dia.)
E32-T16		Not used	NT: 1,070 mm*2 NM: 1,000 mm*2 NV: 1,070 mm*2 NVG: 150 mm*2	NT: 5.0-mm dia. (0.15-mm dia.) NM: 5.0-mm dia. (0.2-mm dia.) NV: 5.0-mm dia. (0.15-mm dia.) NVG: 7.0-mm dia. (1.0-mm dia.)
		0.5 mm wide	NT: 480 mm NM: 450 mm	NT: 5.0-mm dia. (0.1-mm dia.) NM: 5.0-mm dia. (0.2-mm dia.)
		1.0 mm wide	NT: 850 mm NM: 800 mm	NT: 5.0-mm dia. (0.1-mm dia.) NM: 5.0-mm dia. (0.3-mm dia.)

*1 Values at the sensing distance of 100 mm. Values not in parentheses represent sensing objects within the 11-mm sensing area except values for the T16. The values for the T16 represent sensing objects within the 10-mm sensing area. The diameters of sensing objects in the above table represent sensing object sizes, on condition that the objects are not moving.

*2 Visual field NT/NV: 2 x 10 mm, NM: 10 mm width, NVG: 2 x 10 mm.

Sensing Direction

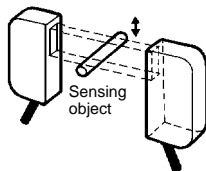

Mounting Bracket for E32-T16P (Option)

Sold in pairs.

Model	Applicable fibers	Appearance
E39-L94	E32-T16P	See page 36.

Specifications

■ Ratings/Characteristics

Amplifier Unit

Item	General-purpose		Multi-function		Four-channel		Waterproof red light source	Waterproof green light source
	E3X-NT11	E3X-NT41	E3X-NT21	E3X-NT51	E3X-NM11	E3X-NM41	E3X-NV21	E3X-NVG21
NPN/PNP output	NPN	PNP	NPN	PNP	NPN	PNP	NPN	NPN
Indicator	Orange LED: Lit during output operation Green LED: Lit with stable light reception or no light							
Circuit protection	Reverse polarity, output short-circuit, mutual interference prevention							
Ambient temperature	Operating: -25°C to 55°C (with no icing) Storage: -40°C to 70°C (with no icing)							
Ambient humidity	Operating: 35% to 85% (with no condensation)							
Ambient illumination	Sunlight: 10,000 lx max.; Incandescent lamp: 3,000 lx max.							
Insulation resistance	20 MΩ min. (at 500 VDC)							
Dielectric strength	1,000 VAC, 50/60 Hz for 1 min							
Vibration resistance	10 to 55 Hz, 1.5-mm double amplitude or 300 m/s ² (approx. 30G) for 2 hrs each in X, Y, and Z directions							
Shock resistance	500 m/s ² (approx. 50G) for 3 times each in X, Y, and Z directions							
Degree of protection	IEC60529 IP50 (with protective cover in place)						IEC60529 IP66 (with protective cover in place)	
Material	Case: PBT; Cover: Polycarbonate						Case: Heat-resisting ABS; Cover: Polycarbonate	
Cord length	Prewired (2 m)							
Connection method	V _{cc} : Brown 0 V: Blue Control output: Black Remote teaching input: Pink (E3X-NT21/-NT51 only)				V _{cc} : Brown 0 V: Blue Control output 1: Black Control output 2: White Control output 3: Grey Control output 4: Orange Remote teaching input: Pink		V _{cc} : Brown 0 V: Blue Control output : Black Remote teaching input: Pink	
Weight (with 2-m cord)	Approx. 100 g				Approx. 200 g		Approx. 100 g	

Fiber Unit

Common

Ambient storage temperature	Heat-resistive fiber: -40°C to 110°C (with no icing) Other fibers: -40°C to 70°C (with no icing)
Ambient storage humidity	Operating: 35% to 95% (with no condensation)
Vibration resistance	10 to 55 Hz, 1.5-mm double amplitude for 2 hrs each in X, Y, and Z directions
Shock resistance	500 m/s ² (approx. 50G) for 3 times each in X, Y, and Z directions

Through-beam (Separate) Sensors

Model	Ambient temperature	Ambient humidity	Permissible bending radius	Material	Degree of protection	
E32-T11L	Operating: -40°C to 70°C (with no icing)	Operating: 35% to 85%	25 mm min.	Black polyethylene	IEC60529 IP67	
E32-T12L						
E32-T21L						
E32-T22L						
E32-TC200						
E32-TC200B E32-TC200B4						
E32-T22						
E32-TC200E						
E32-TC200F E32-TC200F4						
E32-TC200A						
E32-T11						
E32-T21						
E32-T14L						
E32-T24						
E32-T14						
E32-T17L						
E32-T12F	Operating: -30°C to 70°C (with no icing)		40 mm min.	Teflon-covered* ¹ black polyethylene		
E32-T14F						
E32-M21	Operating: -40°C to 70°C (with no icing)		25 mm min.	Black polyethylene		
E32-T51	Operating: -40°C to 150°C* ² (with no icing)		35 mm min.	Fluoride resin		
E32-T54						
E32-T61	Operating: -40°C to 300°C* ³ (with no icing)		25 mm min.	SUS		

*¹ Teflon is a registered trademark of the Dupont Company and the Mitsui Dupont Chemical Company for their fluoride resin.

*² When used continuously between -40°C and 130°C.

*³ The resistive temperature varies with the part of the Fiber Unit. For details, refer to Dimensions.

Reflective Sensors

Model	Differential travel	Ambient temperature	Ambient humidity	Permissible bending radius	Material	Degree of protection
E32-D11L	20% of max. of sensing distance	Operating: -40°C to 70°C (with no icing)	Operating: 35% to 85%	25 mm min.	Black polyethylene	IEC60529 IP67
E32-D12						
E32-D21L						
E32-D22L						
E32-DC200						
E32-DC200B E32-DC200B4						
E32-DC200E						
E32-DC200F E32-DC200F4						
E32-D11						
E32-D21						
E32-DC9G E32-DC9G4						
E32-D33						
E32-CC200						
E32-D32						
E32-D32L						
E32-D14L						
E32-D24						
E32-D12F		Operating: -30°C to 70°C (with no icing)		40 mm min.	Teflon-covered black polyethylene*1	
E32-D51		Operating: -40°C to 150°C (with no icing)*2		35 mm min.	Fluoride resin	
E32-D61		Operating: -40°C to 300°C (with no icing)*3		25 mm min.	SUS	
E32-D73		Operating: -40°C to 400°C (with no icing)*3				
E32-R21 with E39-R3		Operating: -40°C to 70°C (with no icing)				Black polyethylene
E32-R16 with E39-R1		Operating: -25°C to 55°C (with no icing)				IEC60529 IP50
E32-L25*4	5% of max. of sensing distance	Operating: -40°C to 70°C (with no icing)		10 mm min. (average at 10% decrease of sensing distance)	Reinforced polyethylene	
E32-L25A*4						
E32-L25L*4						
E32-L24L*4						

Note: The Sensor may be set to the light-ON state if the sensitivity (teaching) is set to maximum, in which case, use the Sensor at a sensitivity setting other than the maximum level.

*1 Teflon is a registered trademark of the Dupont Company and the Mitsui Dupont Chemical Company for their fluoride resin.

*2 When used continuously between -40°C and 130°C.

*3 The resistive temperature varies with the part of the Fiber Unit. For details, refer to *Dimensions*.

*4 Beam size: 2-mm dia.

*5 For continuous operation, use the products within the temperature ranging from -40°C to 90°C.

Fine Through-beam Sensors

Model	Beam size	Differential travel	Horizontal positioning accuracy	Ambient temperature	Ambient humidity	Permissible bending radius	Material	Degree of protection
E32-T22S	13 mm dia. (at a distance of 200 mm)	---	---	Operating: -40°C to 70°C (with no icing)	Operating: 35% to 85%	10 mm min.*	Reinforced laminated vinyl chloride	IEC60529 IP67
E32-T24S								
E32-T84S				Operating: -40°C to 200°C (with no icing)		25 mm min.	SUS	

* Average at 10% decrease of sensing distance

Slot Sensor

Model	Ambient temperature	Ambient humidity	Permissible bending radius	Material	Degree of protection
E32-G14	Operating: -40°C to 70°C (with no icing)	Operating: 35% to 85%	25 mm min.	Fiber sheath: Black polyethylene	IEC60529 IP67



High-precision Screen Fiber Unit

Model	Ambient temperature	Ambient humidity	Permissible bending radius*1	Material	Degree of protection
E32-T16P	Operating: -40°C to 70°C (with no icing)	Operating: 35% to 85%	10 mm min.	Sensing head: Heat-resistive ABS Fiber sheath: Vinyl chloride	IEC60529 IP50
E32-T16			25 mm min.	Sensing head: Heat-resistive ABS Sensing surface: PMMA Fiber sheath: Black polyethylene	IEC60529 IP67

*1 Average at 10% decrease of sensing distance

*2 Attachments: two slits each (0.5 mm and 1.0 mm wide)

Attachments



Name		Small Spot Lens Unit	Long Distance Lens Unit		
Applications		Detection over 0.5-mm-dia. spots	Increasing sensing distance		
Model		E39-F3A	E39-F1		
Appearance		Reflective 	Through-beam (separate) 		
Applicable fibers		E32-D32	E32-T11L	E32-TC200 E32-T61	E32-T11
With E3X-NT□□	Sensing distance	22 mm*1	1,280 mm	2,100 mm	1,400 mm
	Standard object	White paper 2.5 x 2.5 cm	Opaque objects: 4-mm dia. min.		
With E3X-NM□□	Sensing distance	20 mm*1	1,200 mm	2,000 mm	1,300 mm
	Standard object	White paper 2.5 x 2.5 cm	Opaque objects: 4-mm dia. min.		
With E3X-NV21	Sensing distance	22 mm*1	1,280 mm	2,100 mm	1,400 mm
	Standard object	White paper 2.5 x 2.5 cm	Opaque objects: 4-mm dia. min.		
With E3X-NVG21	Sensing distance	---	120 mm	190 mm*2	120 mm
	Standard object	---	Opaque objects: 4-mm dia. min.		
Directivity		---	5° to 40°		
Differential travel		20% of sensing distance	---		
Ambient temperature		Operating: -40°C to 70°C	E32-T61: -40°C to 200°C (Do not exceed the operating temperature of the fiber.)		
Material	Shaft	Aluminum	Brass		
	Lens	Optical glass			
	Base	---			
	Reflector	---			

*1 When inserting 15 mm.

*2 130 mm for the E32-T61.

Name		Side-view Unit		
Applications		Changing the sensing direction at °90		
Model		E39-F2		
Appearance		Through-beam (separate) 		
Applicable fibers		E32-T11L	E32-TC200	E32-T61/11
With E3X-NT□□	Sensing distance	265 mm	265 mm	210 mm
	Standard object	Opaque objects: 3-mm dia. min.		
With E3X-NM□□	Sensing distance	250 mm	250 mm	200 mm
	Standard object	Opaque objects: 3-mm dia. min.		
With E3X-NV21	Sensing distance	265 mm	265 mm	210 mm
	Standard object	Opaque objects: 3-mm dia. min.		
With E3X-NVG21	Sensing distance	10 mm	19 mm	10 mm
	Standard object	Opaque objects: 4-mm dia. min.	Opaque objects: 3-mm dia. min.	
Directivity		20° to 60°		
Differential travel		---		
Ambient temperature		E32-T61: -40°C to 200°C (Do not exceed the operating temperature of the fiber.)		
Material	Shaft	Brass		
	Lens	Optical glass		
	Base	---		
	Reflector	---		

Name		Lens-equipped Reflective Unit		
Applications		Converting through-beam sensors to reflective sensors		
Model		E39-F3		
Appearance		Reflective 		
Applicable fibers		E32-T11L	E32-TC200	E32-T61
With E3X-NT□□	Sensing distance (standard object)	White paper	55 to 160 mm*1	85 to 110 mm*1
		Black paper	---	16 to 18 mm*1 17 to 19 mm*1
With E3X-NM□□	Sensing distance (standard object)	White paper	55 to 150 mm*1	85 to 100 mm*1
		Black paper	---	15 to 17 mm*1 16 to 18 mm*1
With E3X-NV21	Sensing distance (standard object)	White paper	55 to 160 mm*1	85 to 110 mm*1
		Black paper	---	16 to 18 mm*1 16 to 18 mm*1
With E3X-NVG21	Sensing distance (standard object)	White paper	---	10 to 15 mm (2.5 x 2.5 cm)
		Black paper	---	---
Directivity		---		
Differential travel		20% of sensing distance		
Ambient temperature		E32-T61: -40°C to 200°C (Do not exceed the operating temperature of the fiber.)		
Material	Shaft	Brass		
	Lens	Optical glass		
	Base	Aluminum		
	Reflector	---		

Name		Lens-equipped Reflective Unit		Side-view Reflective Unit
Applications		Converting through-beam sensors to reflective sensors		Converting through-beam to reflective sensor
Model		E39-F3		E39-F5
Appearance		Reflective 		Reflective 
Applicable fibers		E32-T11		E32-TC200A
With E3X-NT□□	Sensing distance (standard object)	White paper	90 to 110 mm*1	5 to 32 mm
		Black paper	---	6 to 10 mm
With E3X-NM□□	Sensing distance (standard object)	White paper	90 to 100 mm*1	5 to 30 mm
		Black paper	---	6 to 9 mm
With E3X-NV21	Sensing distance (standard object)	White paper	90 to 110 mm*1	5 to 32 mm
		Black paper	---	6 to 10 mm
With E3X-NVG21	Sensing distance (standard object)	White paper	---	---
		Black paper	---	---
Directivity		---		
Differential travel		20% of sensing distance		
Ambient temperature		E32-T61: -40°C to 200°C (Do not exceed the operating temperature of the fiber.)		Operating: -40°C to 70°C
Material	Shaft	Brass		---
	Lens	Optical glass		---
	Base	Aluminum		Brass
	Reflector	---		Stainless

*1 These values are possible when the angle of the E39-F3 is smallest (parallel).

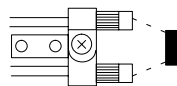

Beam Spot Characteristics

E39-F3A with E32-D32

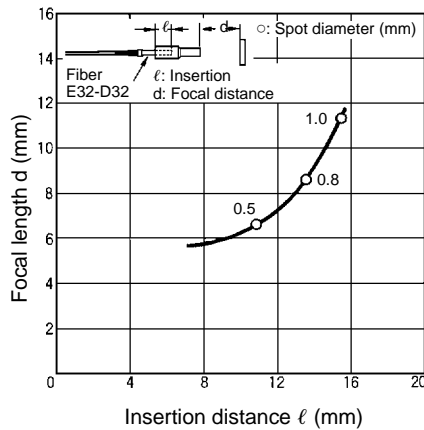

Spiral Tubes

Model	E39-F32A5	E39-F32A	E39-F32B5	E39-F32B	E39-F32C5	E39-F32C	E39-F32D5	E39-F32D
Appearance								
Length (L)	500 mm	1,000 mm	500 mm	1,000 mm	500 mm	1,000 mm	500 mm	1,000 mm
Applicable fiber	E32-DC200E E32-DC200F(4) E32-D21		E32-TC200E E32-TC200F(4) E32-T21 E32-T21L		E32-TC200 E32-TC200B(4) E32-T11 E32-T51 E32-T11L		E32-DC200 E32-DC200B(4) E32-CC200 E32-D11 E32-D51 E32-D11L	
Ambient temperature	Operating: -40°C to 150°C (Do not exceed the operating temperature of the fiber)							
Ambient humidity	Operating: 35% to 85%							
Permissible bending radius	30 mm min.							
Tensile strength	Between head connector and end cap with tube: 1.5 N • m (15 kgf • cm) Tube: 2 N • m (20 kgf • cm)							
Compression load	Tube: 29.4 N (3 kg)							

Accessories

Name	Fiber Cutter	Fine-fiber Attachment	Fiber Connector	Sleeve Bender
Model	E39-F4	E39-F9	E39-F10	E39-F11
Appearance				
Features	Used to cut fibers to desired lengths	Used when inserting fine fibers into the amp	Used to connect fibers for extension	Used to bend fiber sleeves
Applicable fiber	All models equipped with fibers that can be trimmed.	E32-DC200E, -TC200E E32-DC200F(4), -TC200F(4) E32-D21, -D21L, -D22L E32-T21, -T21L, -T22L E32-D32, -T22 E32-D24, -T24 E32-D33 E32-R21, E32-D21R	E32-DC200, -TC200 E32-DC200B(4), -TC200B(4) E32-TC200A E32-T14, -G14 E32-D11L, -T11L, -T12L E32-D14L, -T14L E32-T17L	E32-TC200B(4) E32-DC200F(4), -TC200F(4) E32-DC9G(4)
	Provided with Fiber Units		Sold Separately	

Name	Protection cover	
Model	E39-G10 (see note)	E39-G9
Appearance		
Application	Replacement part: Order when the Protection Cover included with the Amplifier is damaged or lost.	
Applicable Amplifier	E3X-NT	E3X-NM

Note: Cannot be mounted on the push type as shown below.

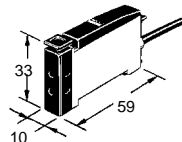

Engineering Data

■ Excess Gain Ratio (Typical)

with Standard Sensing Object at Max. Sensitivity

The characteristics of the E3X-NV are the same as for the E3X-NT.

E32-TC200

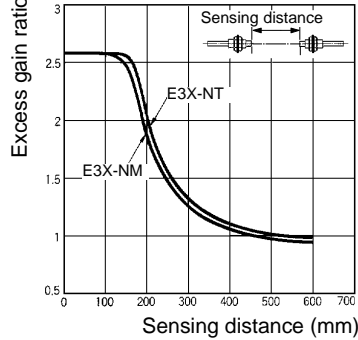

E32-T11L

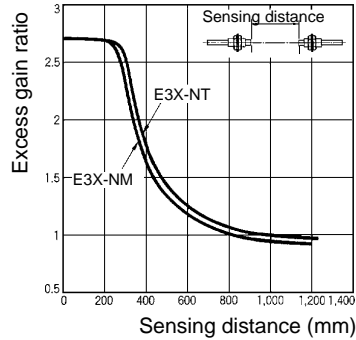

E32-T11L with E39-F1

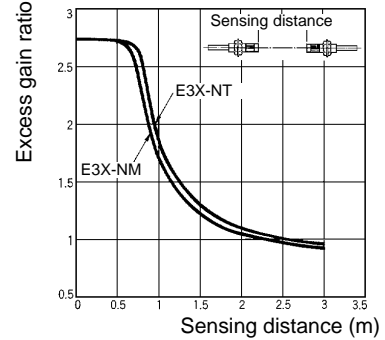

E32-T11L with E39-F2

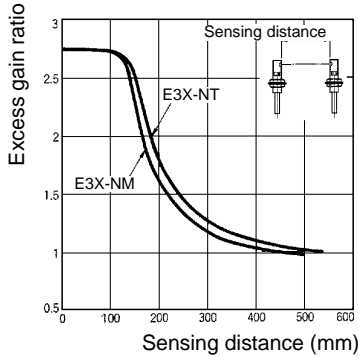

E32-T11L with E39-F3

(When the angle of the E39-F3 is at its minimum (parallel).)

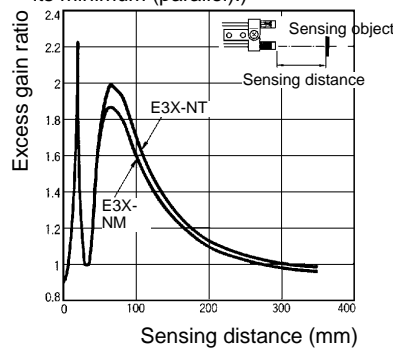

E32-T21L

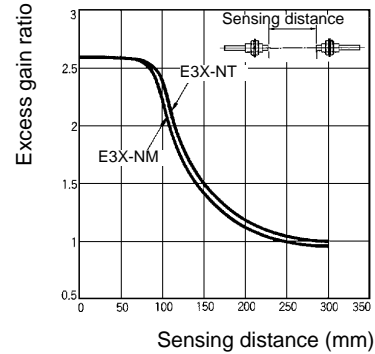

E32-T14L

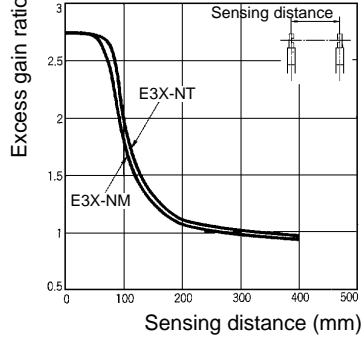

E32-T17L

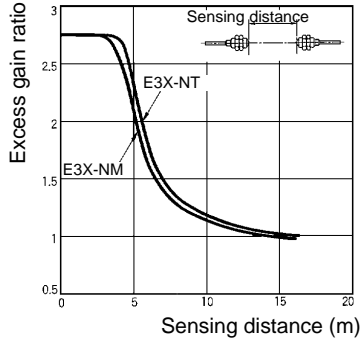

E32-T16

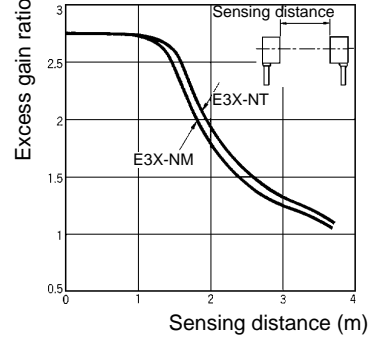

E32-DC200/E32-CC200

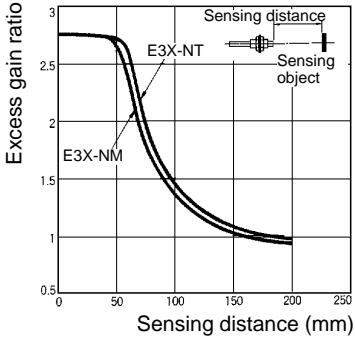

E32-D11L

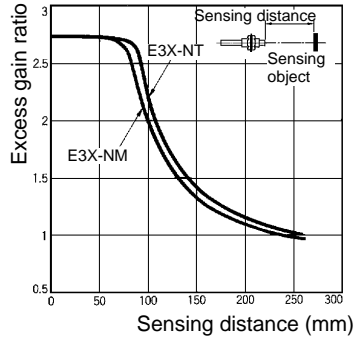

E32-D21L

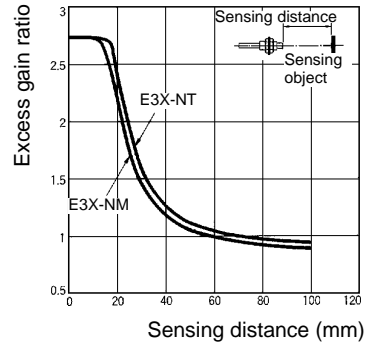

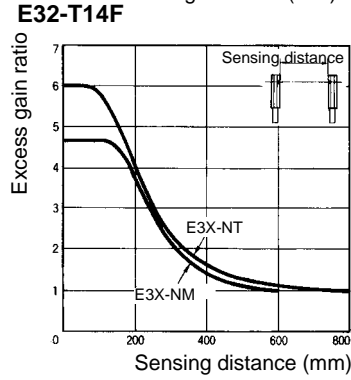
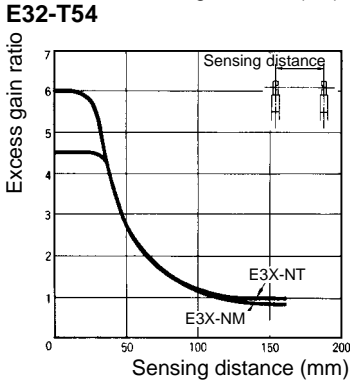
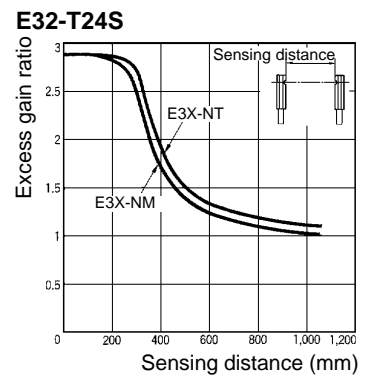
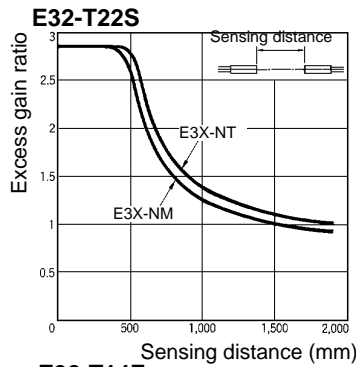
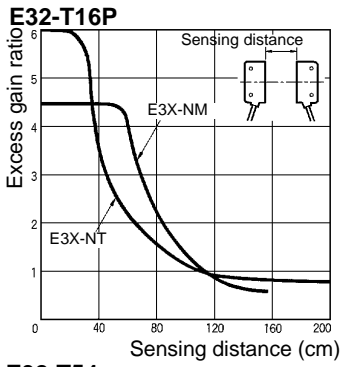

■ Operating Range (Typical)

With standard sensing object at max. sensitivity.

The characteristics of the E3X-NV are the same as for the E3X-NT.

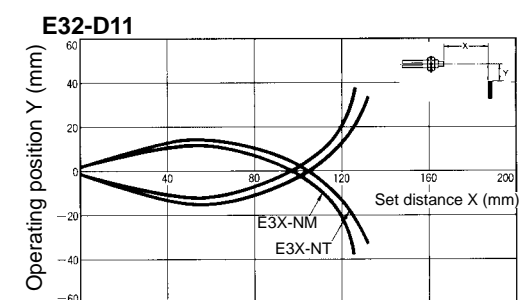
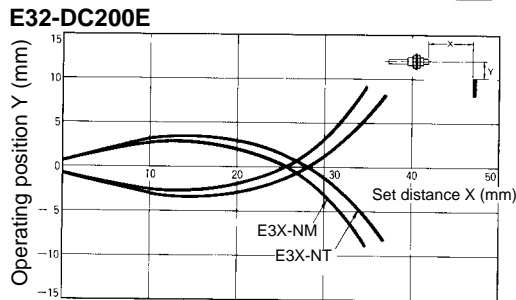
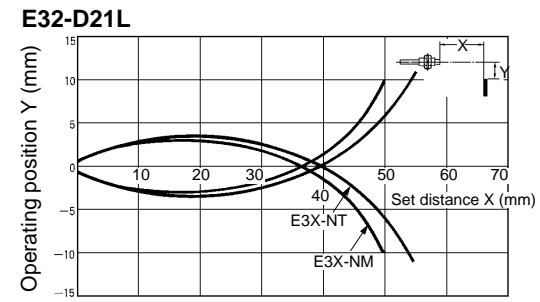
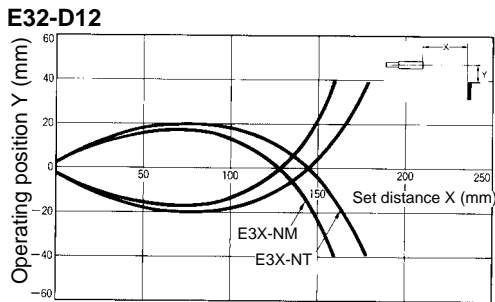
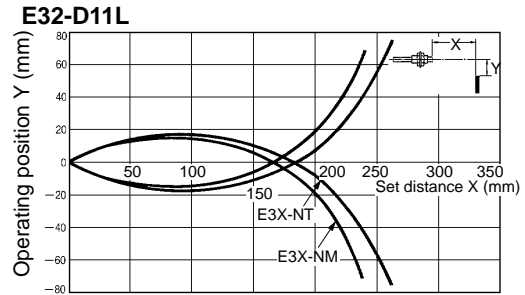
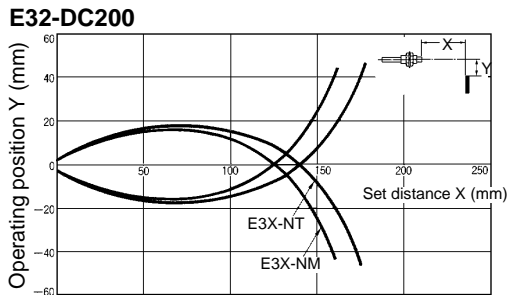

E32-D21

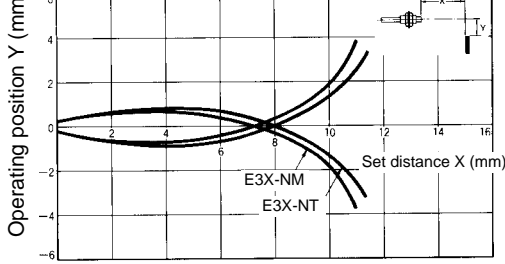

E32-D33

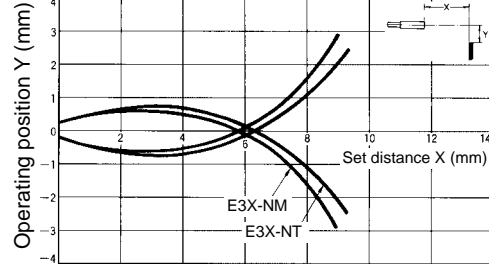

E32-CC200

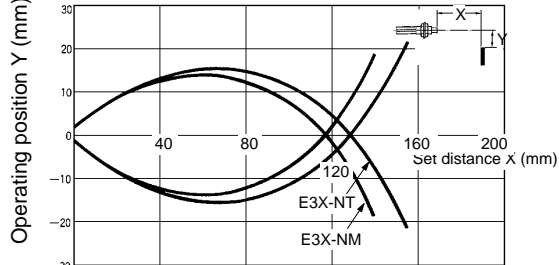

E32-D32

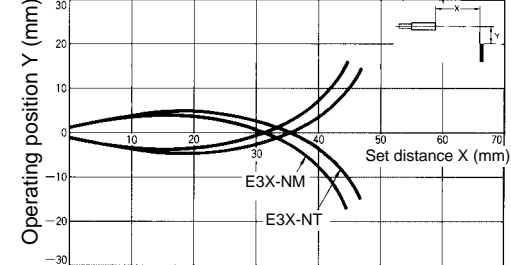

E32-D32L

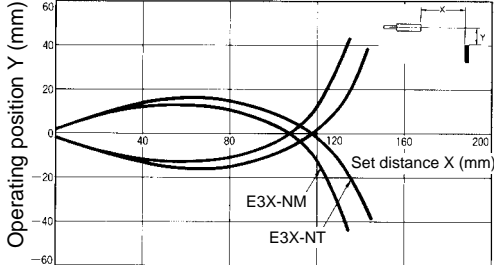

E32-D14L

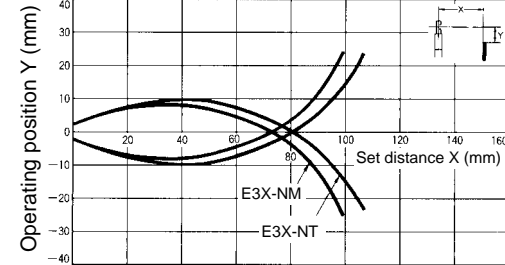

E32-D24

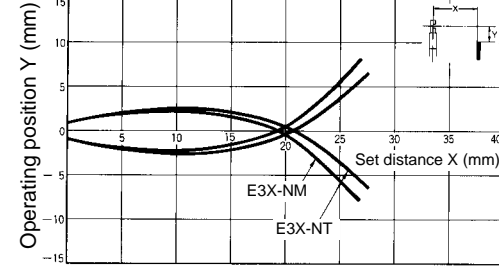

E32-D51

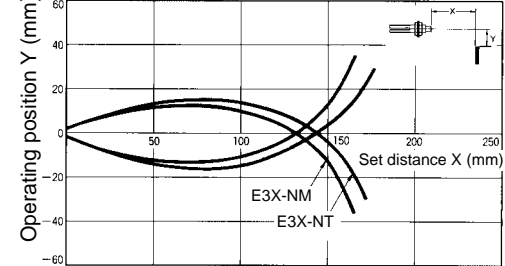

E32-D61

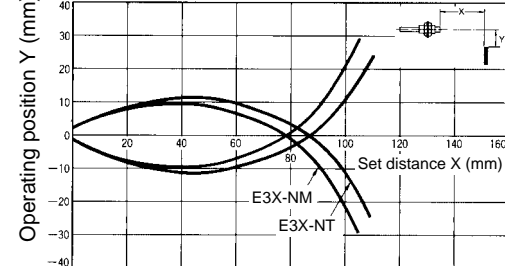

E32-D73

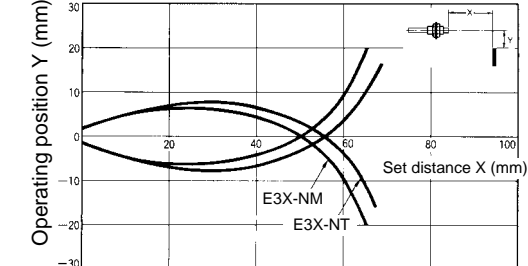

E32-L25

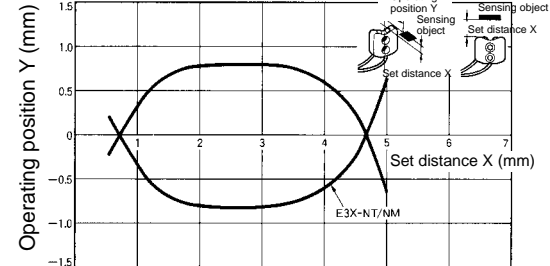

E32-L24L

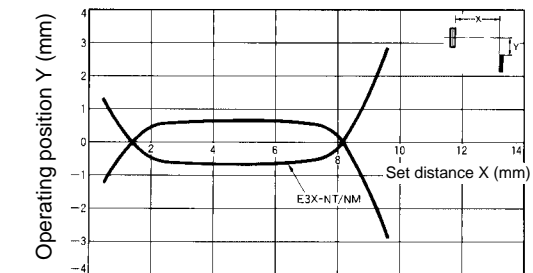

Parallel Operating Range (Typical)

At max. sensitivity.

The characteristics of the E3X-NV are the same as for the E3X-NT.

E32-TC200

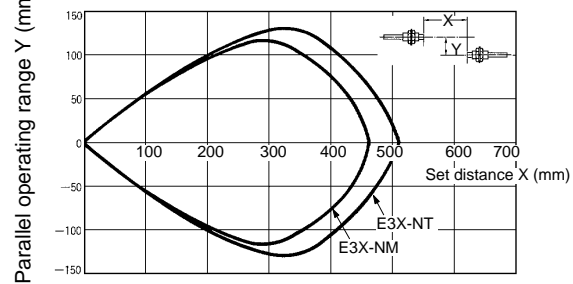

E32-TC200+E39-F1

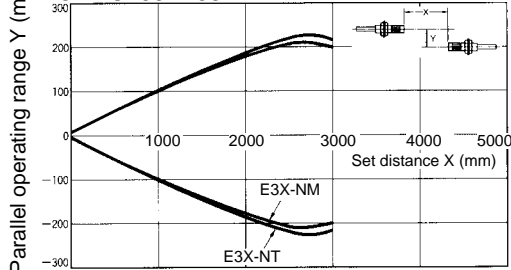

E32-TC200+E39-F2

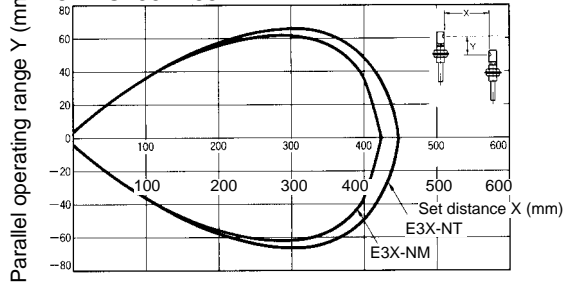

E32-T11L

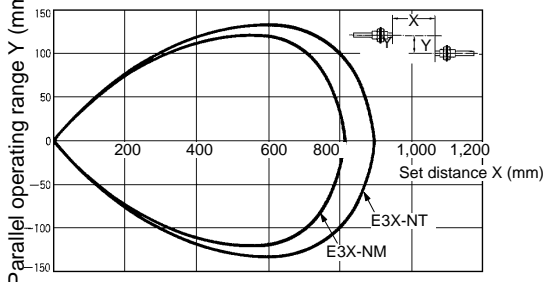

E32-T11L with E39-F1

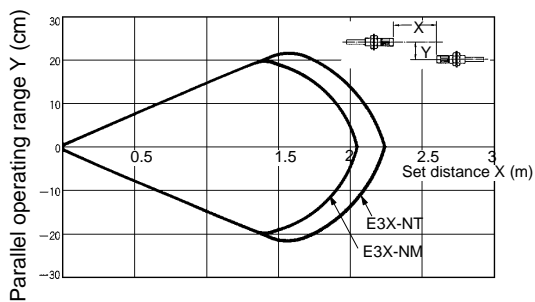

E32-T11L with E39-F2

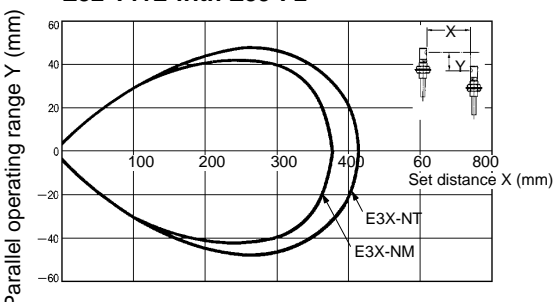

E32-T21L

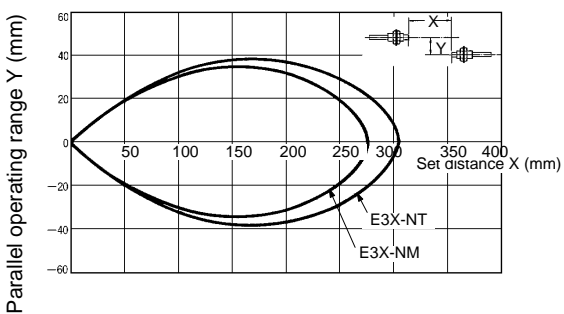

E32-TC200E

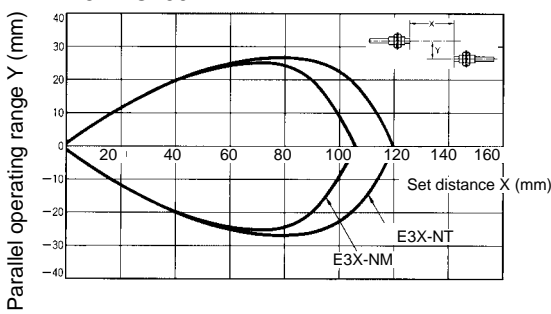

E32-T11

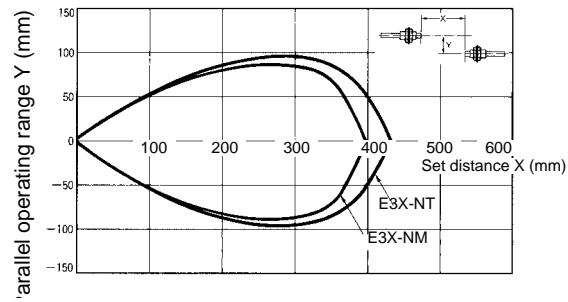

E32-T11+E39-F1

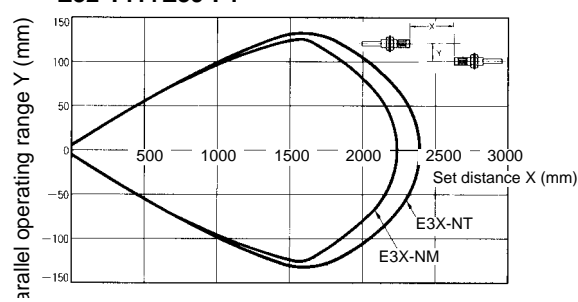

E32-T11+E39-F2

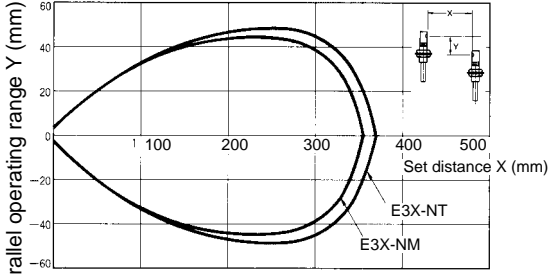

E32-T21

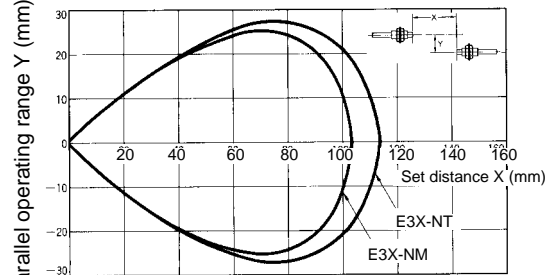

E32-T14L

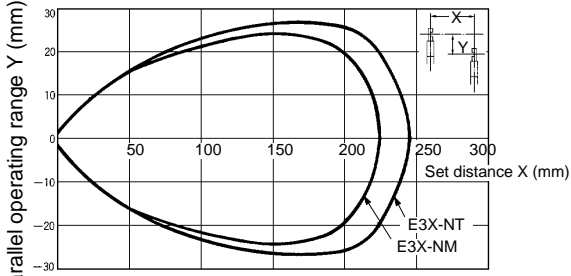

E32-T14

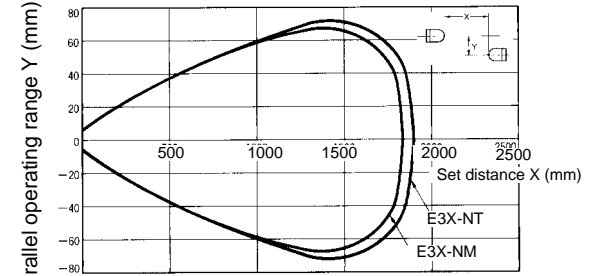

E32-T24

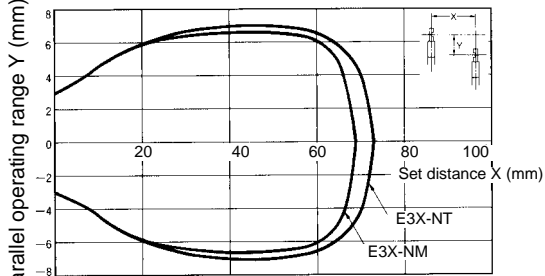

E32-T17L

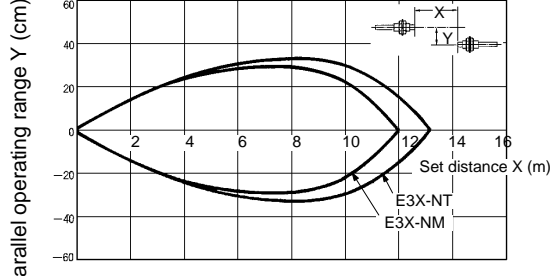

E32-T12F

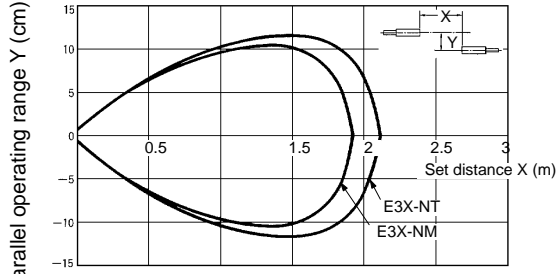

E32-M21

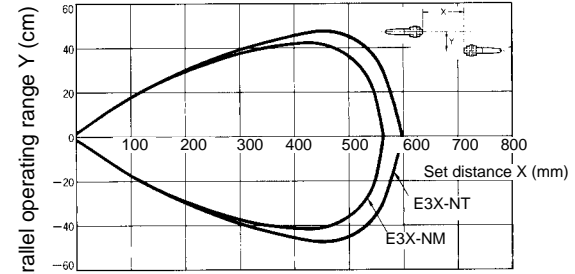

E32-T51

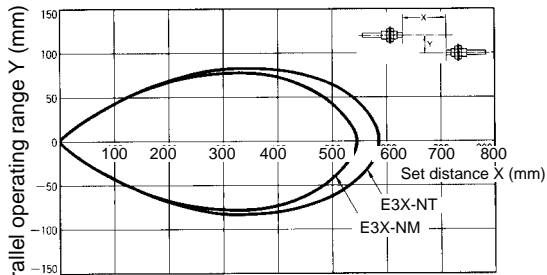

E32-T61

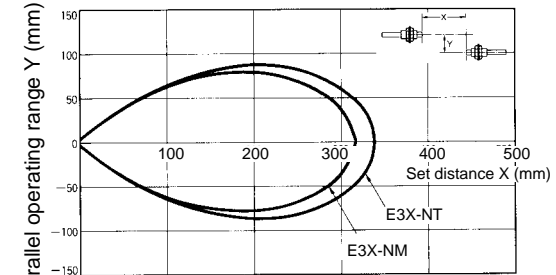

E32-R21+E39-R3

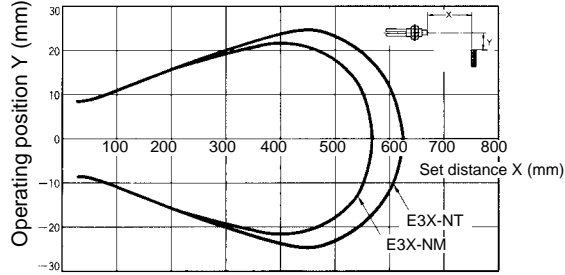

E32-R16+E39-R1

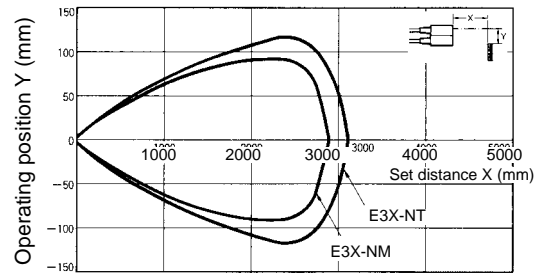

E32-T25S

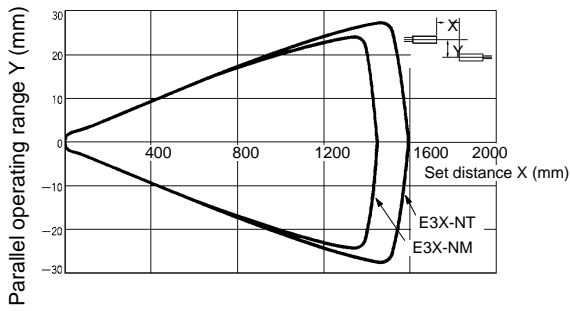

E32-T24S

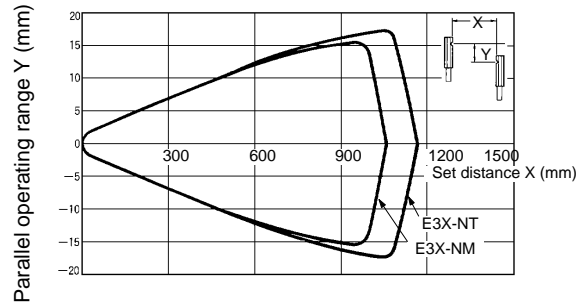

E32-T16P

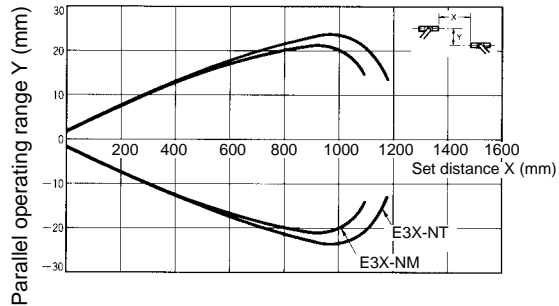

E32-T16P

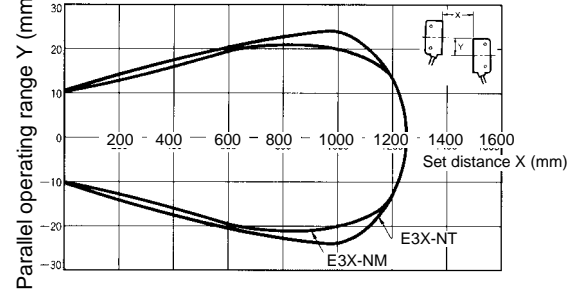

E32-T54

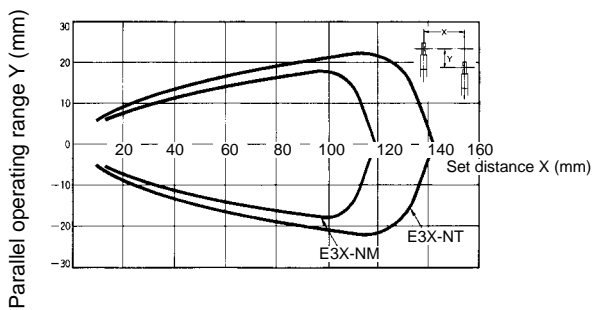

E32-T14F

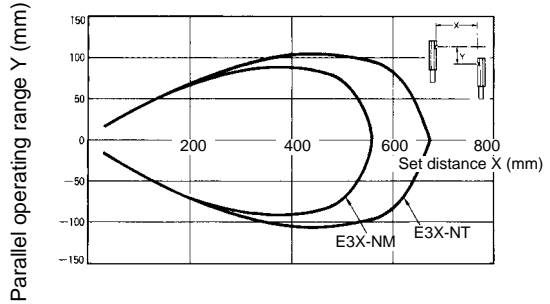

■ Sensing Objects vs. Operating Range (Typical)

The characteristics of the E3X-NV are the same as for the E3X-NT.

E32-DC200 with E3X-NT11

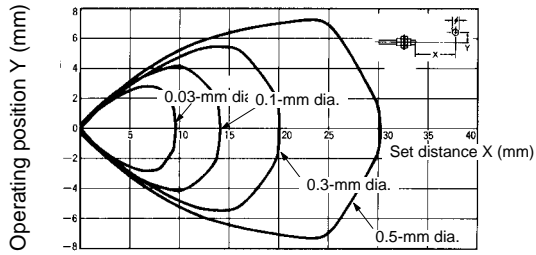

E32-DC200 with E3X-NM11

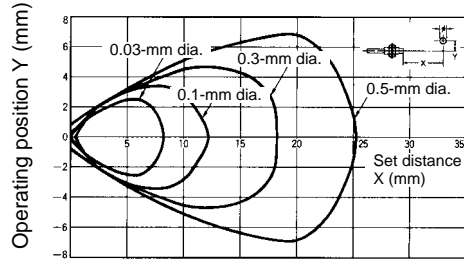

E32-D22L with E3X-NT11

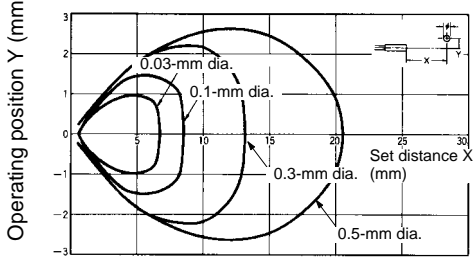

E32-D22L with E3X-NM11

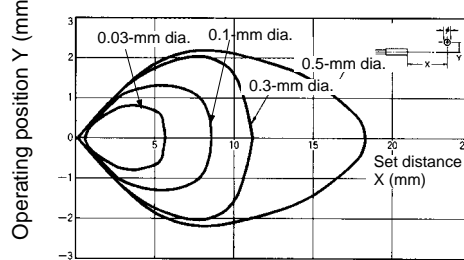

E32-D11L with E3X-NT11

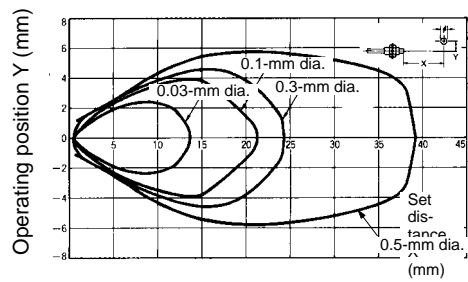

E32-D11L with E3X-NM11

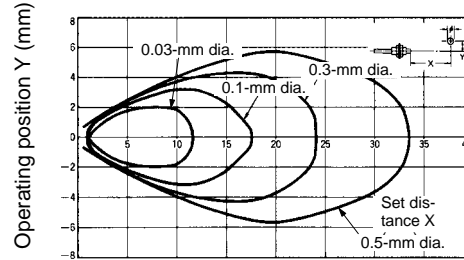

E32-D33 with E3X-NT11

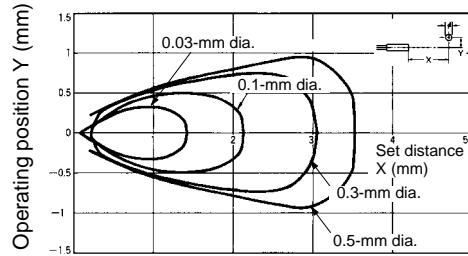

E32-D33 with E3X-NM11

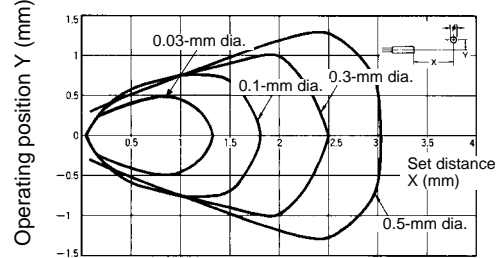

E32-CC200 with E3X-NT11

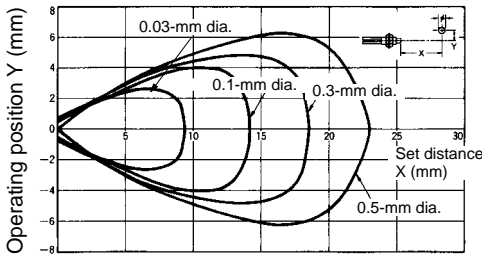

E32-CC200 with E3X-NM11

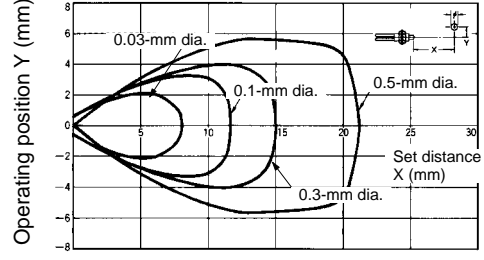

E32-D32 with E3X-NT11

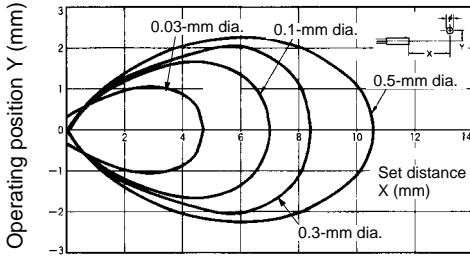

E32-D32 with E3X-NM11

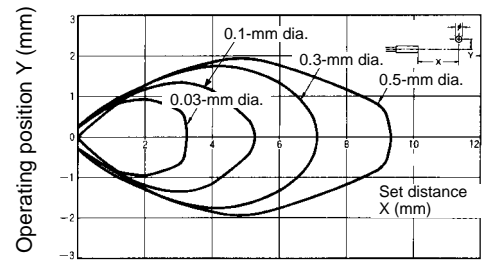

■ Excess Gain vs. Sensing Distance (E3X-NVG)

E32-D11L

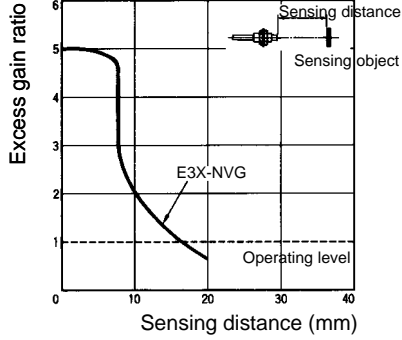

E32-T11L, -T12L

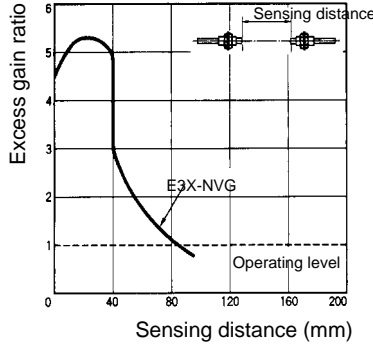

■ Parallel Operating Range (E3X-NVG)

E32-T11L, -T12L

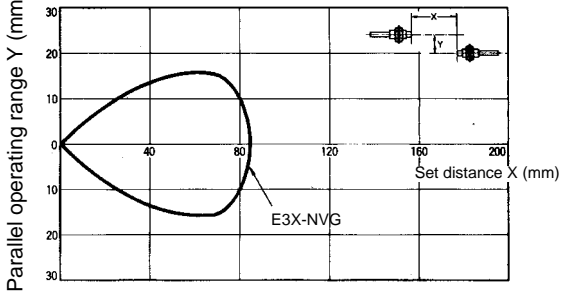

E32-D11L

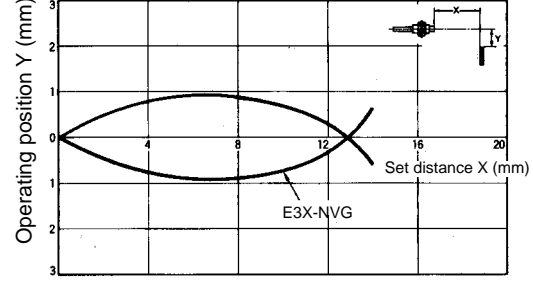

Nomenclature

E3X-NT11 (NPN)
E3X-NT21 (NPN)
E3X-NT41 (PNP)
E3X-NT51 (PNP)

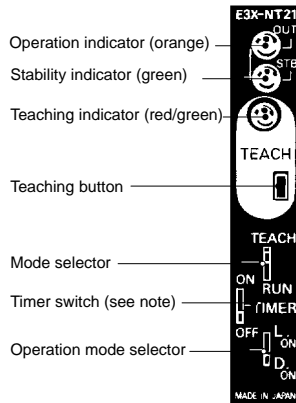

E3X-NM11 (NPN)
E3X-NM41 (PNP)

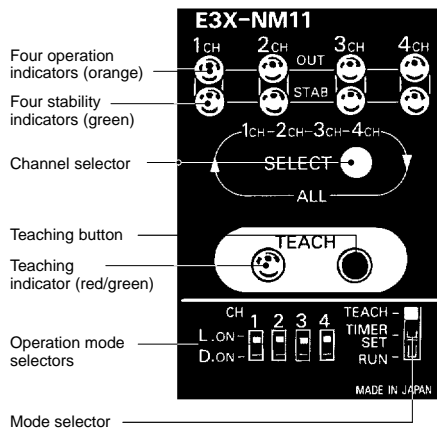

E3X-NV21 (NPN)
E3X-NVG21 (NPN)

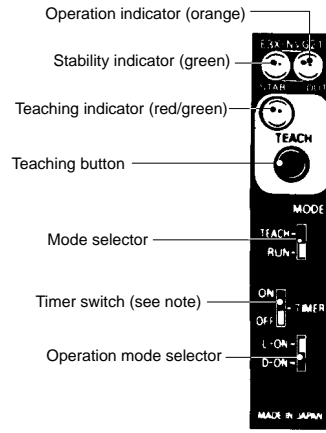

Note: The E3X-NT11 or E3X-NT41 do not have a timer function.

Operation

Output Circuits

E3X-NT11

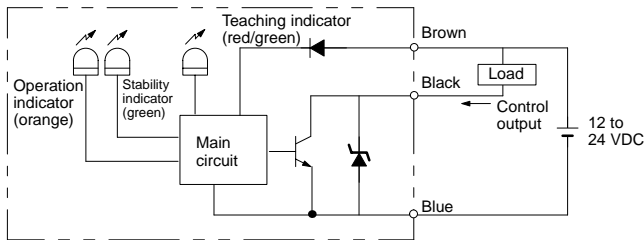

E3X-NT21/E3X-NV21/E3X-NVG21

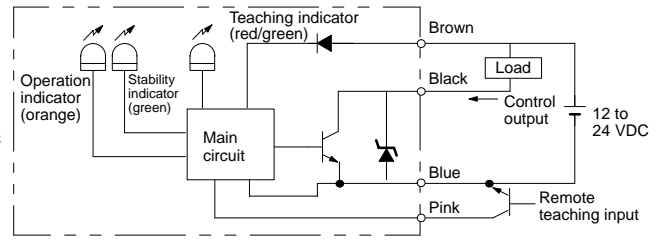

E3X-NM11

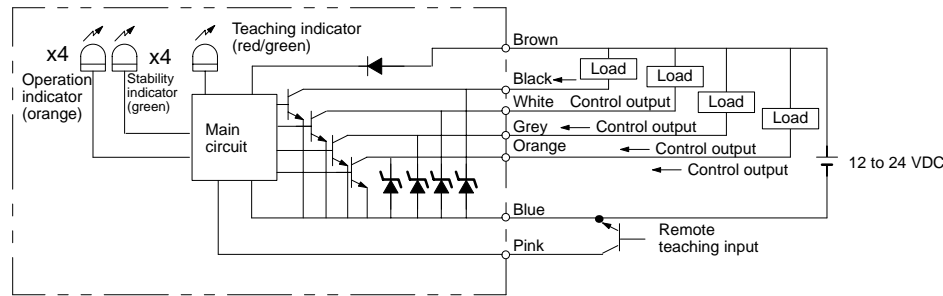

E3X-NT41

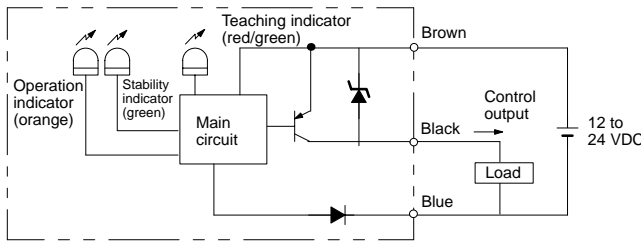

E3X-NT51

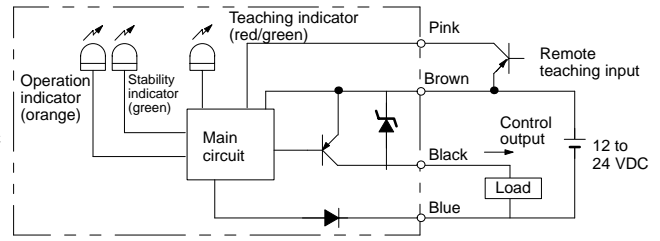

E3X-NM41

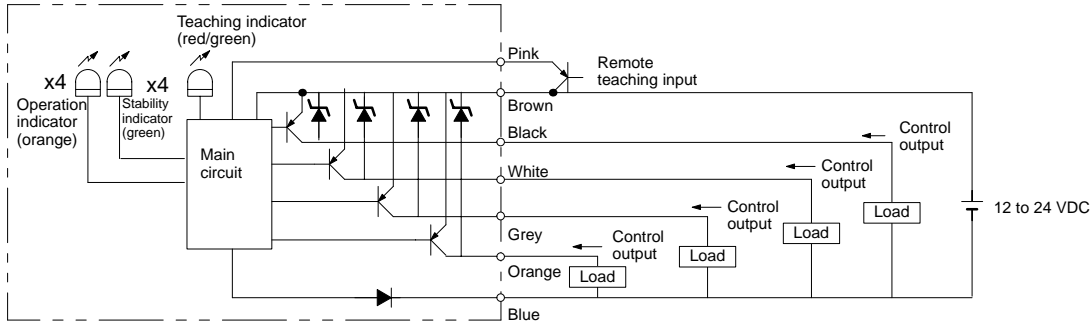

Channel no.	Control output wire color
1	Black
2	White
3	Grey
4	Orange

■ With/Without-object Teaching, No-object Teaching, Maximum Sensitivity Setting

Refer to the following table to select the most suitable sensitivity setting method.

Sensitivity setting method	Maximum sensitivity setting	No-object teaching	With/Without-object teaching
Typical application	Detection of the existence of objects that interrupt light perfectly Detection of objects with no background objects	If teaching is impossible by stopping the movement of sensing objects	Detection of a slight difference in reflection Color discrimination
		To detect bright or dark objects by teaching only with background objects	Background objects with unstable reflection Detection of object surface irregularities
		Elimination of background object influence	

- Note:**
1. None of the four channels has any output when the E3X-NM (four channels) is in teaching mode (i.e., all the four channels will be in teaching mode).
 2. If the set distance is very short (i.e., 0 to 12 mm for the E32-TC200 and 0 to 4 mm for the E32-DC200), no-object teaching is not possible due to excessive light, in which case, perform with/without-object teaching.
 3. In principle, use the E3X-NM (four channels) for the close connection of a maximum of four Fiber Units. When closely connecting two to three Fiber Units to more than one E3X-NT (one channel), perform with/without-object teaching, in which case teaching must be performed on a single E3X-NT at a time. Therefore, turn on only the E3X-NT on which teaching is performed. If all the E3X-NTs are turned on, interrupt the emitters of the Fiber Units on which teaching is not performed.

■ No-object Teaching with an Initial Operating Level Compensation Function With Through-beam (Dark-ON) Fiber Unit

1. Teaching button is pressed once.
2. The first sensing object is in the sensing area.

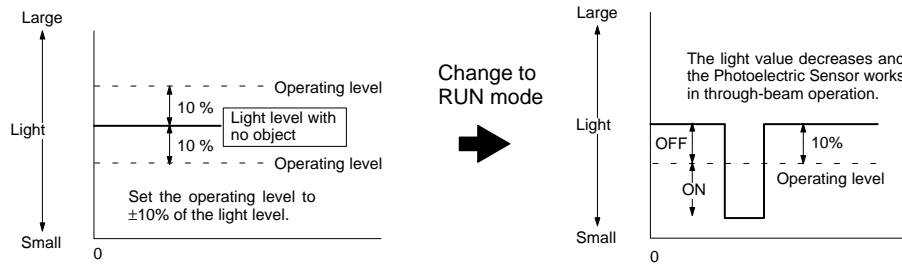

3. Sensing objects continue to pass through the sensing area.

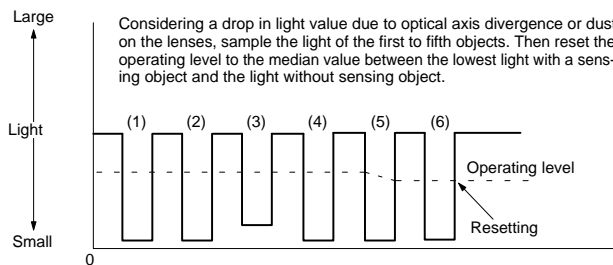

With Reflective (Light-ON) Fiber Unit

1. Teaching button is pressed once.
2. The first sensing object is in the sensing area.

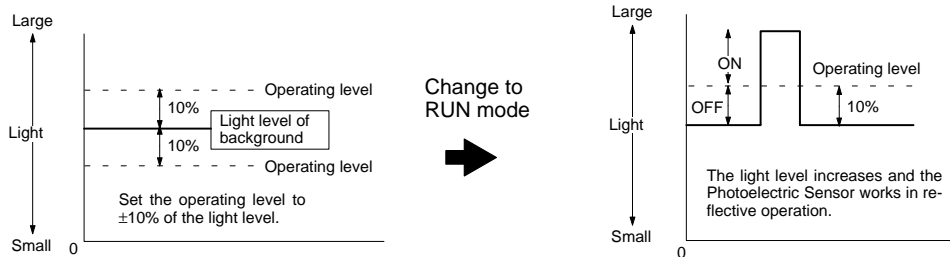

3. Sensing objects continue to pass through the sensing area.

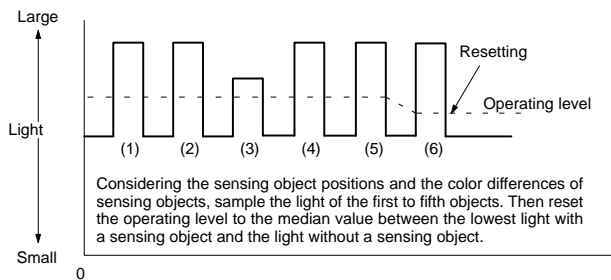

Note: If the light value up to the fifth object is at least twice as large as the operating level, the initial set operating level (10%) will be maintained.

- Note:**
1. After no-object teaching, when the E3X-N□ is turned off and on, the operation level will be set to the +10% of the initial light level (refer to the above (1)) in reflective operation and -10% of the initial light level in through-beam operation and stand by.
 2. After performing no-object teaching and changing to RUN mode, until the first sensing object is in the sensing area, the control output will be prohibited (OFF). The control output will be determined when the first sensing object is detected.
 3. The initial operating level compensation function will operate after teaching and/or after the E3X-N□ is turned on.
 4. During no-object teaching, after the E3X-N□ is in RUN mode, each channel requires approximately 60 ms to determine the operating level from the time the first sensing object is in the sensing area. Therefore, when using the E3X-NM (four channels), set an interval of 60 ms minimum for each channel if sensing objects are forwarded in sequence to the sensing area of each channel. After the operating level is determined, the E3X-NM will operate with a normal response speed of 500 μs.

■ Sensitivity Adjustment

Combination of the E3X-NT/E3X-NM and Fine Through-beam Fiber Units (E32-T22S/T24S/T84S)

No-object Teaching

Press the teaching button once with no wafer in the sensing area.

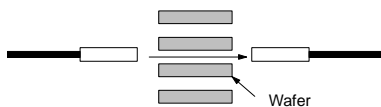

With/Without-object Teaching

Press the teaching button once with no wafer in the sensing area.

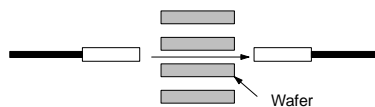

Note: If detection is not stable after no-object teaching, perform with/without-object teaching.

Press the teaching button once again with a wafer in the sensing area.

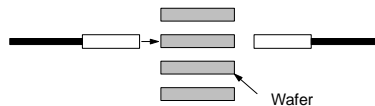







Maximum Sensitivity Setting

Note: The sensitivity of the E3X-NT and E3X-NM are set to maximum before shipping. When resetting the sensitivity of the E3X-NT or E3X-NM to maximum after no-object teaching or with/without-object teaching, follow the steps described below.

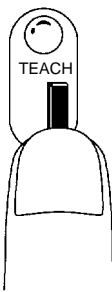
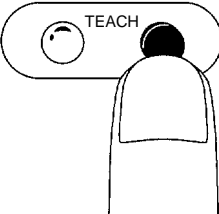
Procedure	Operation	E3X-NT	E3X-NM
1	Locate the sensor head within the rated sensing range with the E3X-N□.		
2	Set the mode selector to TEACH.		
3	The super-flashing function of the E3X-N□ will be activated. Therefore, adjust the optical axes so that the tip of the emitting fiber will be lit. If the optical axes are divergent, the tip of the emitting fiber will flash and the built-in buzzer of the E3X-N□ will beep.	---	
4	Press the teaching button for three seconds minimum with or without a sensing object. In the case of the E3X-NM, select a channel with the channel selector, at which time the stability indicator for the selected channel will flash. The teaching indicator (red) turns green. The built-in buzzer beeps once when the color of the teaching indicator is red. The built-in buzzer beeps continuously when the color of the teaching indicator is green. Note: The built-in buzzer will stop beeping when the teaching button is no longer being pressed.		
5	Set the mode selector to RUN to complete the sensitivity setting. The teaching indicator is OFF. Note: When the sensitivity is set to maximum, the sensitivity will be automatically adjusted regardless of the set distances of the fibers or light.		
6	Select the logical output required with the operation mode selector.		

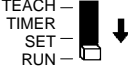
No-object Teaching

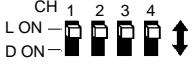
Procedure	Operation	E3X-NT	E3X-NM
1	Locate the sensor head within the rated sensing range with the E3X-N□.		
2	Set the mode selector to TEACH.		
3	The super-flashing function of the E3X-N□ will be activated. Therefore, adjust the optical axes so that the tip of the emitting fiber will be lit. If the optical axes are divergent, the tip of the emitting fiber will flash and the built-in buzzer of the E3X-N□ will beep.	---	
4	Press the teaching button for 0.5 to 2.5 seconds without a sensing object. In the case the E3X-NM, select a channel with the channel selector and press the teaching button, at which time the stability indicator for the selected channel will flash. The teaching indicator (red) is lit. The built-in buzzer beeps once.		
5	Set the mode selector to RUN. No-object teaching will be set when the first sensing object passes through the sensing area. The teaching indicator (red) turns green (automatically turned off in one second).		
6	Select the logical output required with the operation mode selector.		

- Note:**
- To detect dark objects in front of bright backgrounds, set the operation mode selector to D. ON.
 - If the set distance is very short (i.e., 0 to 12 mm for the E32-TC200 and 0 to 4 mm for the E32-DC200), no-object teaching is not possible due to excessive light, in which case, perform with/without-object teaching.
 - If the teaching button is pressed for more than three seconds, the sensitivity of the E3X-N□ will be set to maximum, at which time the green indicator will be lit.
 - The E3X-N□ will be ready to detect objects in approximately one second after the mode selector is set to RUN.

Remote Teaching/Timer Set Function

Remote Teaching Function

In principle, the remote teaching function of the E3X-N□ should be used for initial teaching. Basically, the method of remote teaching is the same as that of sensitivity setting. In remote teaching, instead of pressing the teaching button, teaching is performed with a remote teaching input signal.

1. Set the mode selector to RUN.
2. The following signal conditions must be given as remote teaching input conditions.

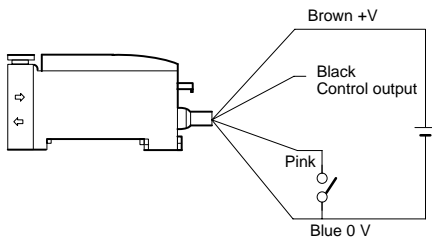

1. In the case of the E3X-NM, teaching is performed on all the four channels of the E3X-NM.
2. If all four channels are not used (e.g., only three channels are used), with/without-object teaching will not be available. In which case, perform the usual with/without-object teaching on the channels that are used instead of performing remote teaching.
3. If remote teaching is not performed, cut the pink wire at the base or connect the pink wire to the +V terminal.
4. After remote teaching input setting is finished, the E3X-N□ will be ready to detect objects in approximately one second.

Power supply		ON OFF
Remote teaching input	With/Without-object teaching	<p>T₁: 0.5 to 2 s T₂: 3 s min.</p>
	Maximum sensitivity setting	<p>T₃: 5 s min.</p>
	No-object teaching	<p>T₄: 0.5 to 2 s T₅: 1.5 to 2 s</p>

Timer Set Function (E3X-NM)

1. Set the mode selector to TIMER SET.
2. Select a channel with the channel selector, at which time the stability indicator for the selected channel will flash.
3. The timer of the E3X-NM will be set by pressing the teaching button of the E3X-NM, at which time the operation indicator will be lit. When the teaching button is pressed again, the timer will be disabled and the operation indicator of the E3X-NM will be lit. To perform setting on other channels repeat procedures 2 and 3.
4. Set the mode selector to RUN.

Note: Channels are selected in the following order.

When all the channels are selected, it is possible to set the timer function on all channels.

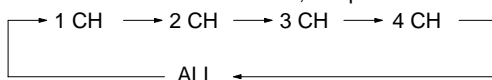

Optical Axis Adjustment (Super-flashing Function)

Set the mode selector of the E3X-N□ to TEACH. The super flashing function of E3X-N□ will be activated. When the optical axes of the fiber heads are divergent and the light value decreases by approximately 10% of the maximum value, the tip of the emitting fiber will start flashing and the built-in buzzer will beep. At this time, if the optical axes are divergent, adjust the axes. The peak light value will be memorized by the E3X-N□. Do not press the teaching button before or while adjusting the optical axes, otherwise, the super-flashing function will not operate.

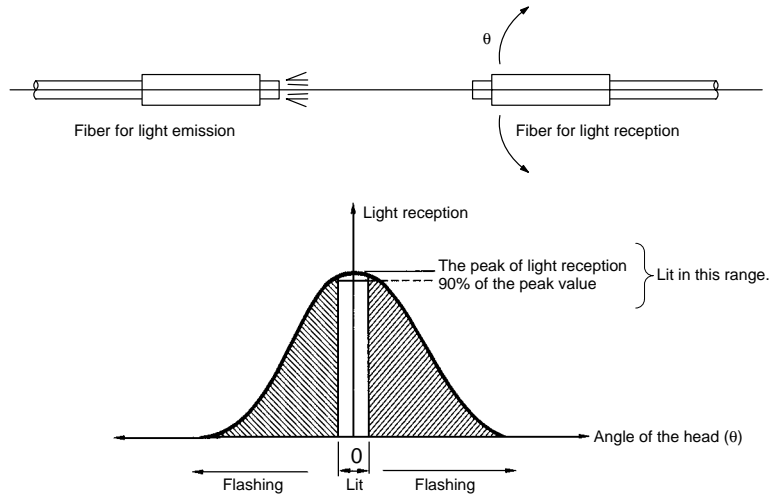

Special Fiber Units

The following special accessories are available (order separately). Contact your OMRON representative for the details.

Fiber Units with Special Length of Stainless Steel Tube

Fiber with different lengths of stainless steel tubes are available.

Applicable Models

- E32-TC200F (tube with 0.9-mm dia.)
- E32-TC200B/DC200F (tube with 1.2-mm dia.)
- E32-DC200B (tube with 2.5-mm dia.)

Appearance



The length can be ordered in increments of 10 mm between 10 mm min. and 120 mm max.

Tolerance: ±1.0 mm if L is 40 mm or less, and ±2.0 mm if L is more than 40 mm. (Note that standard Fiber Units have a 90-mm or 40-mm long stainless steel tube.)

Fiber Units with 90° Bend in Stainless Steel Tube

Applicable Models

E32-TC200B/TC200F/DC200F

Appearance

Stainless Steel Tube with a 90° Bend at the Tip

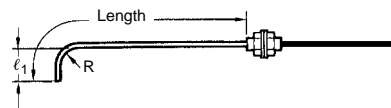

Bending radius	$l_1 (\pm 1)$	
R 5.0	10.0 mm	15.0 mm
R 7.5	12.5 mm	17.5 mm
R 10.0	15.0 mm	20.0 mm
R 12.5	17.5 mm	22.5 mm

The length overall is 120 mm max.

Note: If larger l_1 is required, use the E39-F11 Sleeve Bender.

Stainless Steel Tube with a 90° Bend at the Base

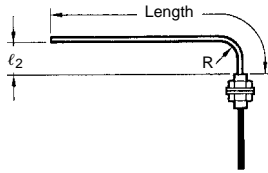

Bending radius	$l_1 (\pm 1)$	
R 5.0	5.0 mm	10.0 mm
R 7.5	7.5 mm	17.5 mm
R 10.0	10.0 mm	20.0 mm
R 12.5	12.5 mm	22.5 mm

The length overall is 120 mm max.

Note: If larger l_2 is required, use the E39-F11 Sleeve Bender.

Sensing Distance for Tubes with 90° Bends

Model	Amplifier	Bending radius				
		Standard	R5.0	R7.5	R10.0	R12.5
E32-TC200B	E3X-NT	290 mm	180 mm	235 mm	255 mm	290 mm
	E3X-NM	270 mm	170 mm	220 mm	240 mm	270 mm
E32-TC200F	E3X-NT	70 mm	32 mm	70 mm	70 mm	70 mm
	E3X-NM	65 mm	30 mm	65 mm	65 mm	65 mm
E32-DC200F	E3X-NT	22 mm	16 mm	22 mm	22 mm	22 mm
	E3X-NM	20 mm	15 mm	20 mm	20 mm	20 mm

Fiber Unit with Longer Fiber

Applicable Models

- E32-TC200/-DC200
- E32-TC200B/-DC200B
- E32-TC200E/-DC200E
- E32-TC200F/-DC200F
- E32-TC200A

Appearance



The length can be ordered in increments of 1 m between 6 m min. and 20 m max. (2 m and 5 m fiber length types are standard for E32-TC200, E32-DC200.)

Fiber Length vs. Sensing Distance

Through-beam Fiber Unit

(Based on the sensing distance using a fiber length of 2 m as 100%)

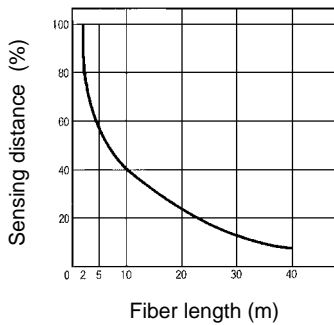

Reflective Fiber Unit

(Based on the sensing distance using a fiber length of 2 m as 100%)

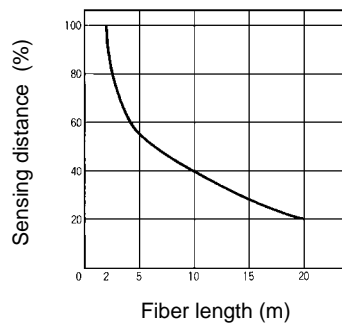

Changes in the Rated Sensing Distance

E32-TC200 with E3X-N□□□

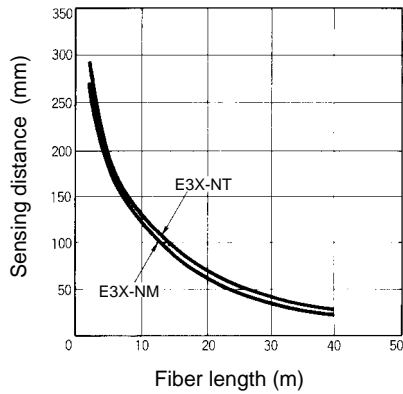

E32-DC200 with E3X-N□□□

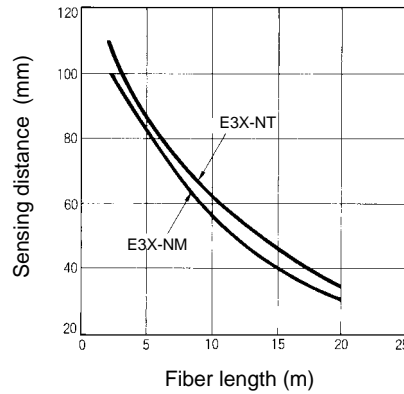

Dimensions

Note: All units are in millimeters unless otherwise indicated.

■ Amplifier

- E3X-NT11
- E3X-NT21
- E3X-NT41
- E3X-NT51

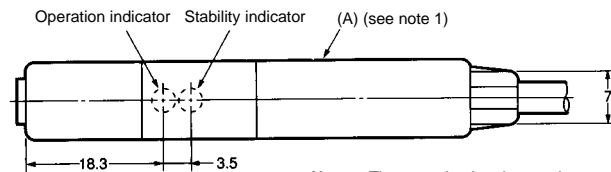
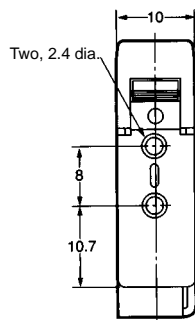
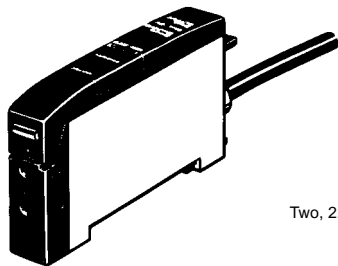

Note: The mounting bracket can be attached to this side.

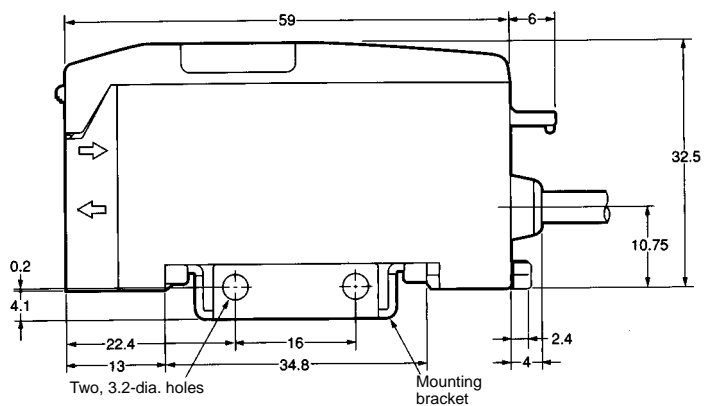

Vinyl insulated round cord
(cord type: see note)
Standard length 2 m

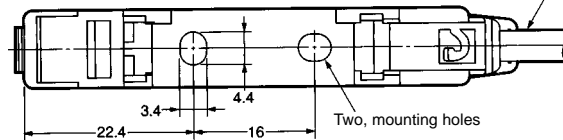

Note: The cord types are as follow:

- Cord: Polyvinyl chloride-covered cord
- E3X-NT11: 4-mm dia. (40/0.12 dia.), 3 cores
- E3X-NT21: 4-mm dia. (40/0.08 dia.), 4 cores
- E3X-NT41: 4-mm dia. (40/0.12 dia.), 3 cores
- E3X-NT51: 4-mm dia. (40/0.08 dia.), 4 cores
- Standard length: 2 m

Weight: Approx. 100 g

E3X-NM11
E3X-NM41

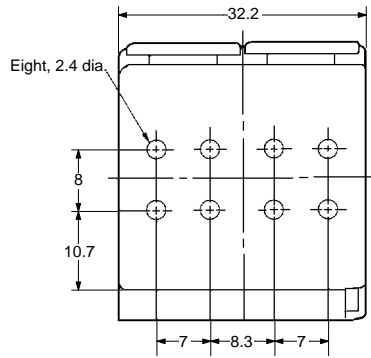
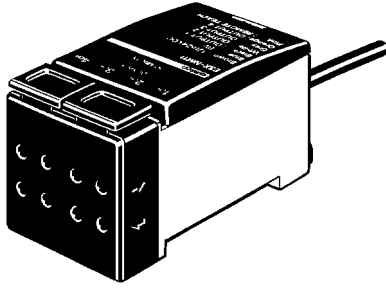

Cord: Polyvinyl chloride-covered cord
4-mm dia. (40/0.08 dia), 7 cores
Standard length: 2 m

Weight: Approx. 200 g

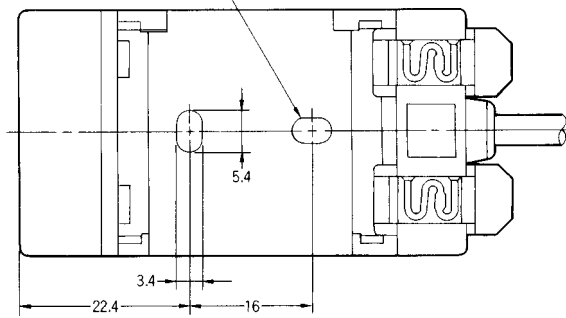
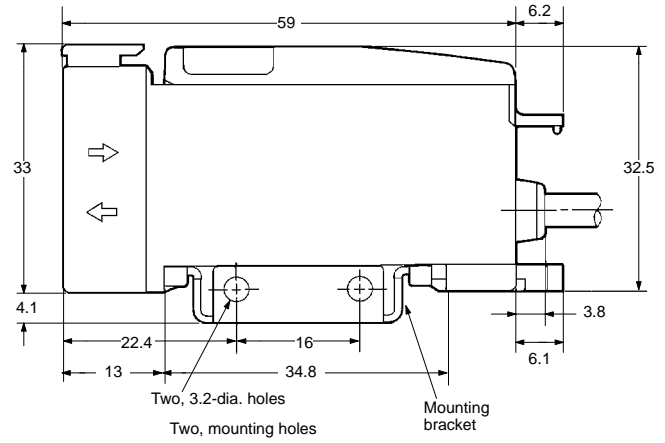
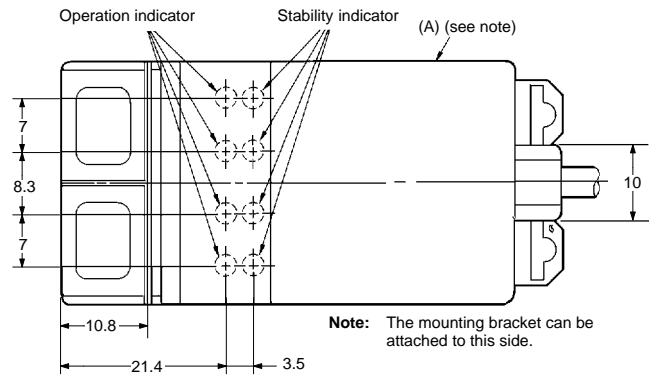

E3X-NV
E3X-NVG

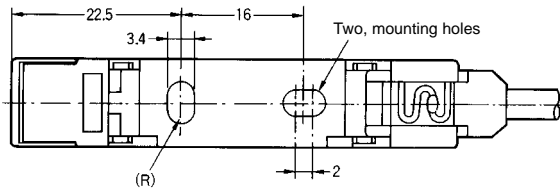
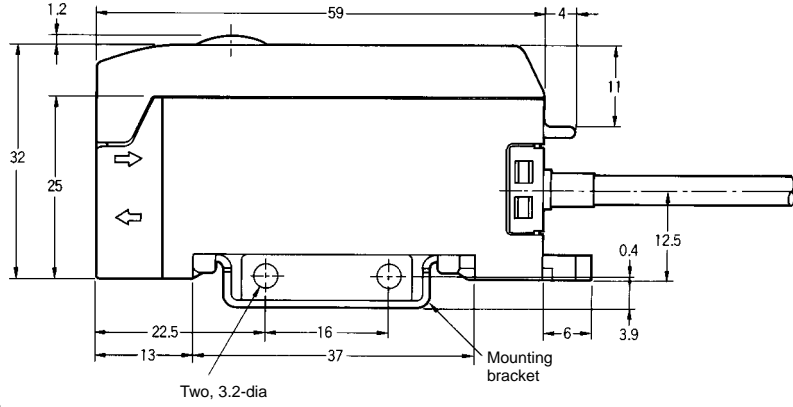
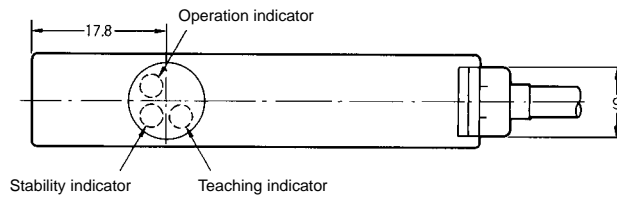
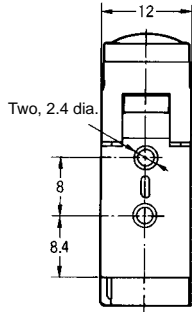
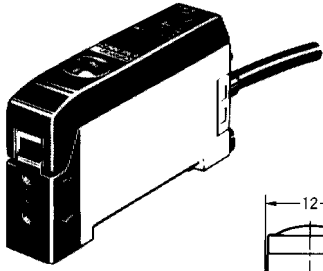

Cord: Polyvinyl chloride-covered cord
4-mm dia. (40/0.08 dia), 4 cores
Standard length: 2 m

Weight: Approx. 100 g

■ Fiber Units

Through-beam (Sold in Pairs)

 Indicates models that allow free cutting. Models without this mark do not allow free cutting.

E32-T11L 

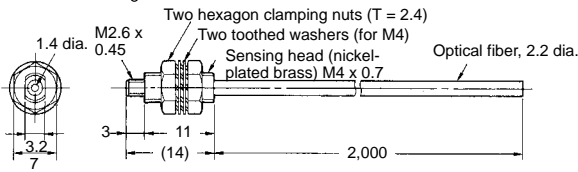

E32-T12L 

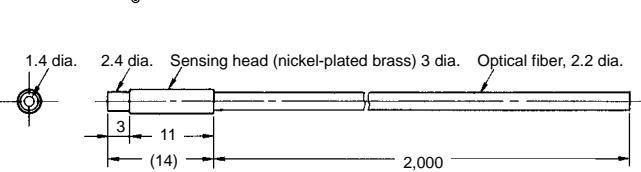

E32-T21L 

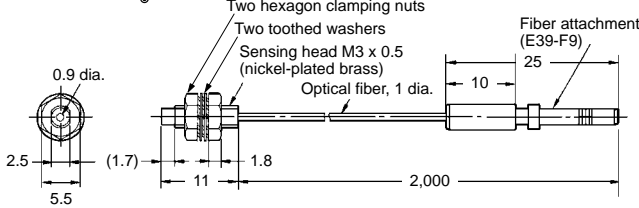

E32-T22L 

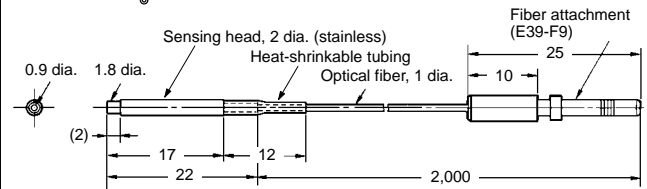

E32-TC200 

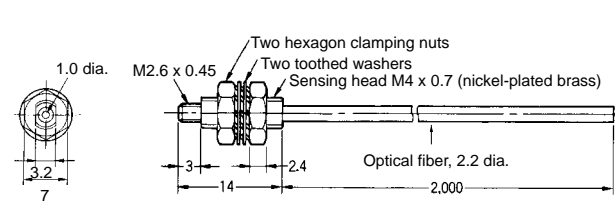

E32-TC200B 
E32-TC200B4

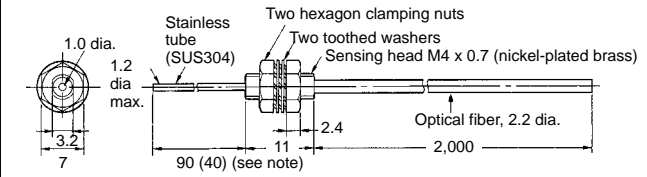

Note: The value in the parentheses is for the E32-TC200B4.

E32-T22 

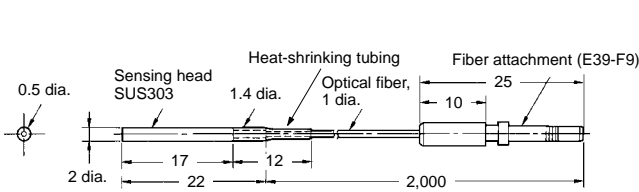

E32-TC200E 

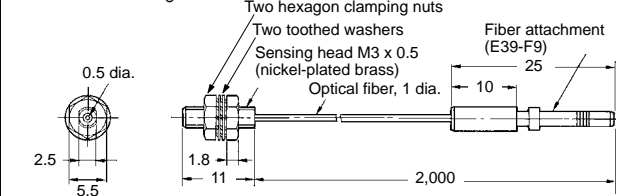

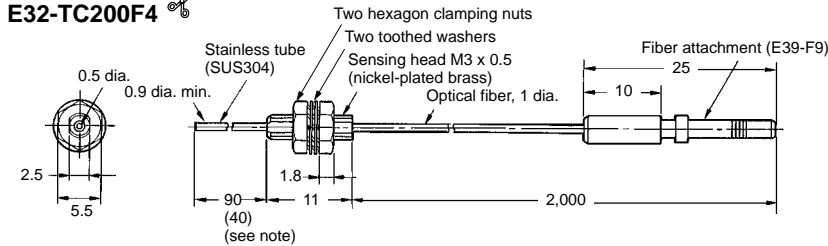

E32-TC200F 
E32-TC200F4

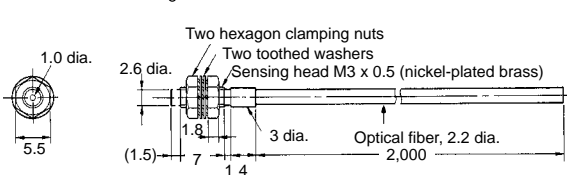

Note: The value in the parentheses is for the E32-TC200F4.

E32-TC200A 



E32-T11 

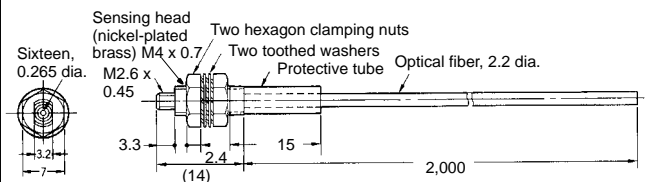

E32-T21

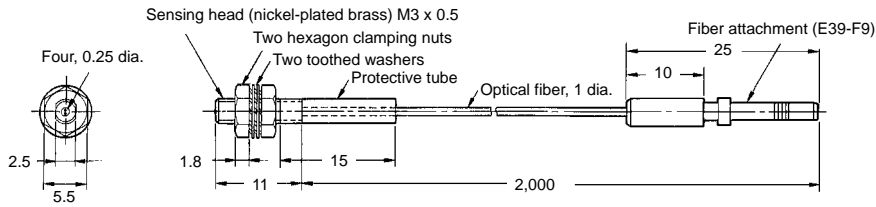

E32-TC200C

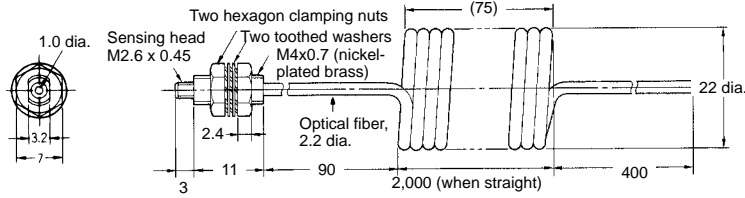

E32-TC200D
E32-TC200D4

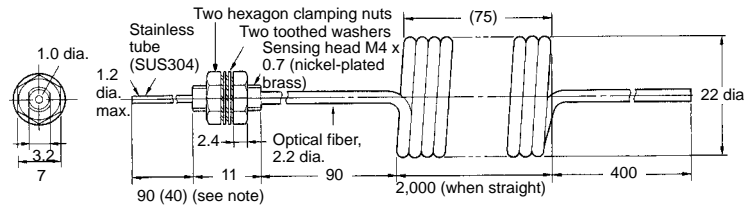

Note: The value in the parentheses is for the E32-TC200D4.

E32-T14L

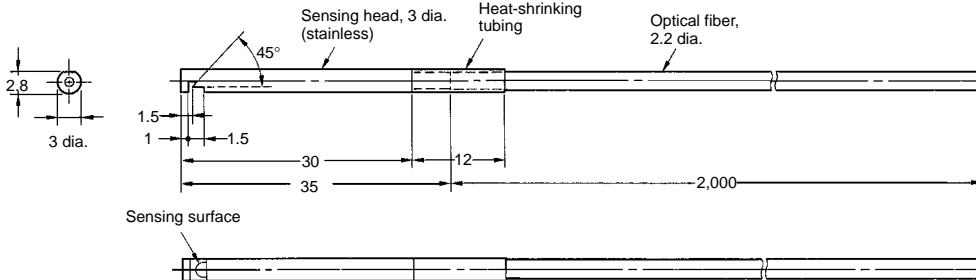

E32-T24

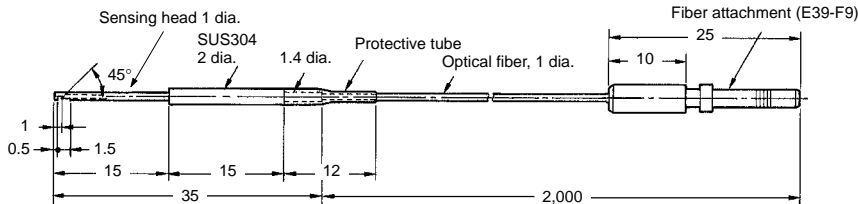

E32-T14

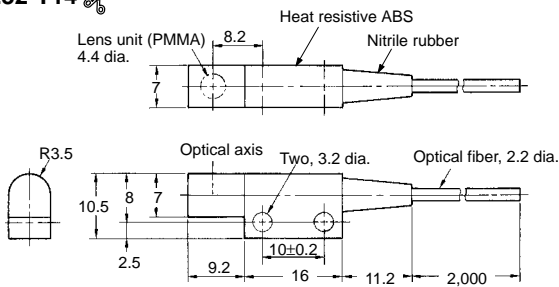

E32-T17L

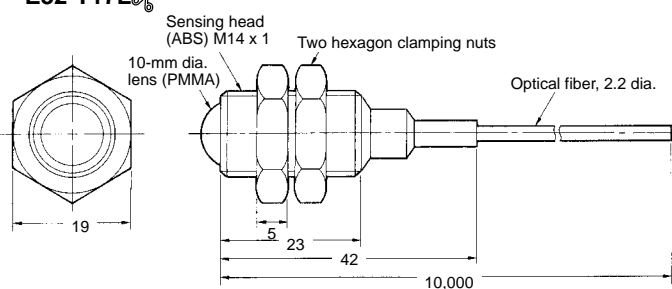

E32-T12F

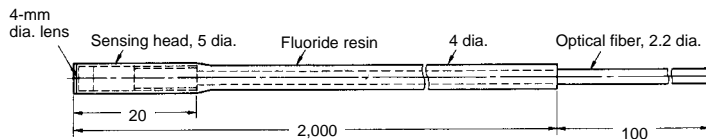

E32-T14F

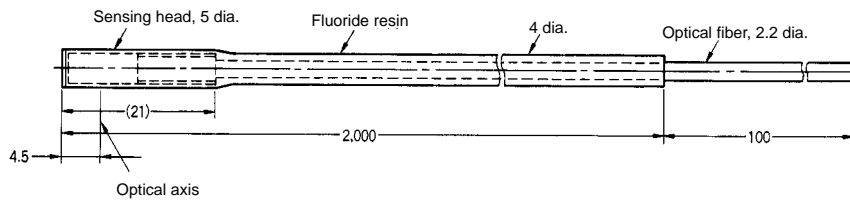

E32-T16

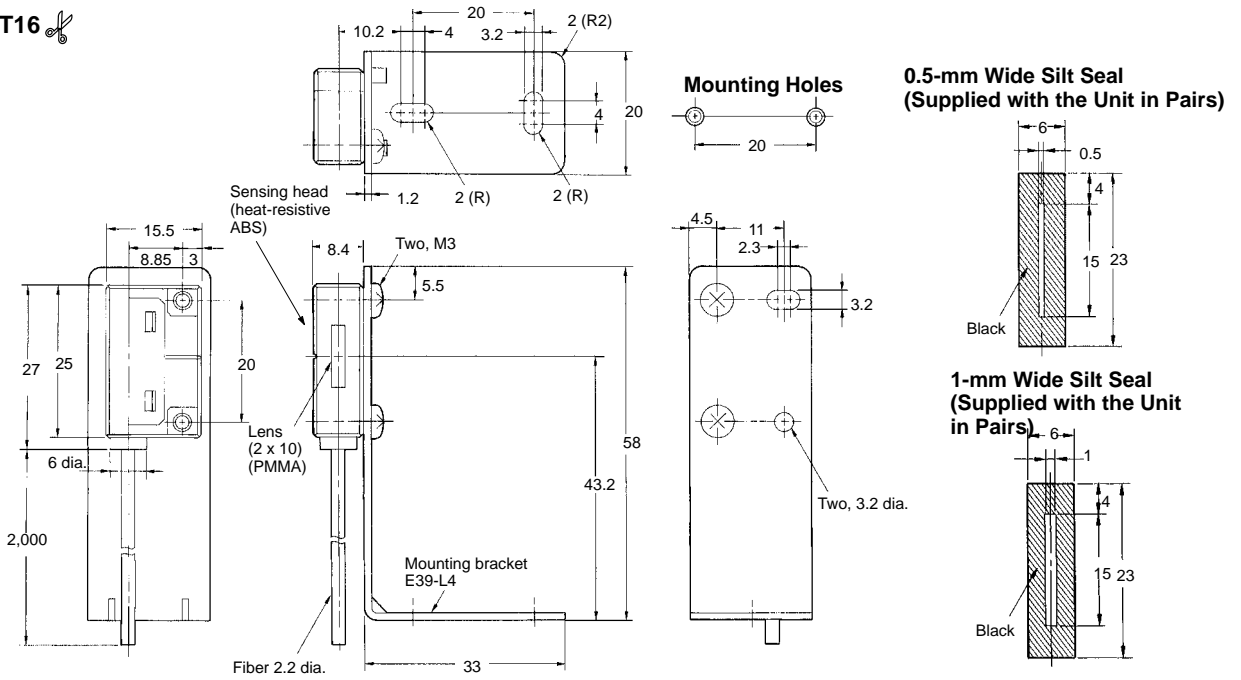

E32-T16P

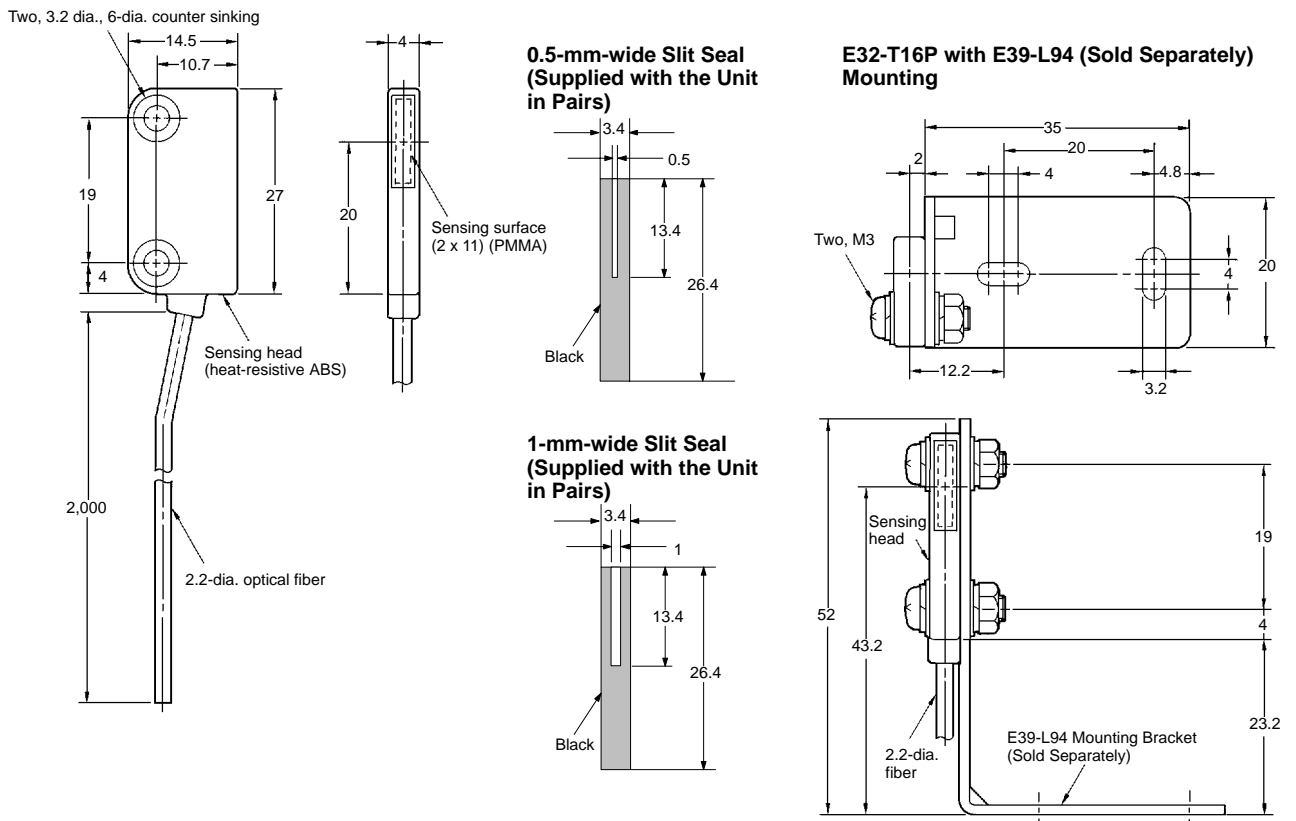

E32-M21

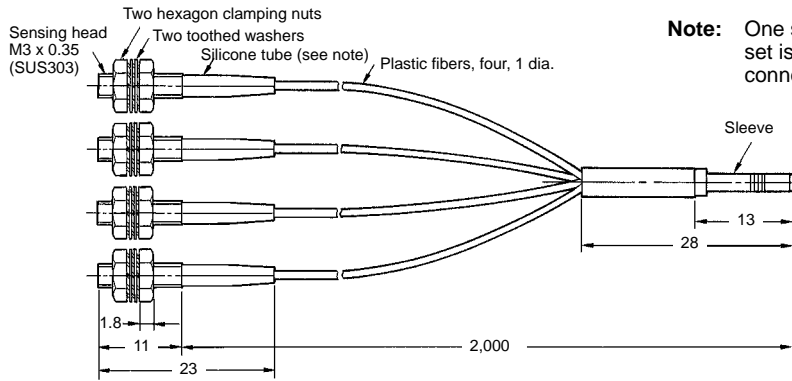

Note: One set of silicone tubes is black while the other set is grey for easy identification when they are connected to the emitter and receiver.

E32-T51

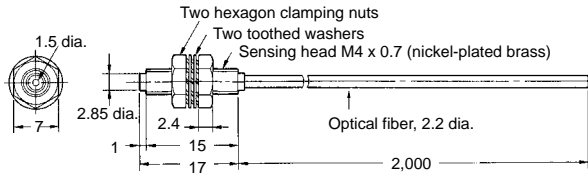

Note: Resistant temperature is 150°C. Resistant temperature is 130°C when used continuously.

E32-T54

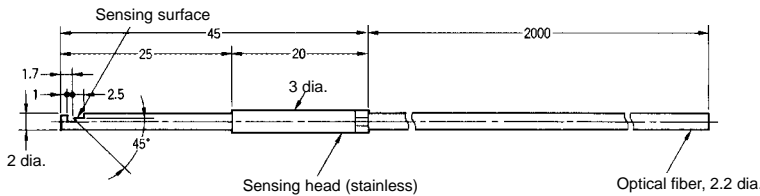

Note: Resistant temperature is 150°C. Resistant temperature is 130°C when used continuously.

E32-T61

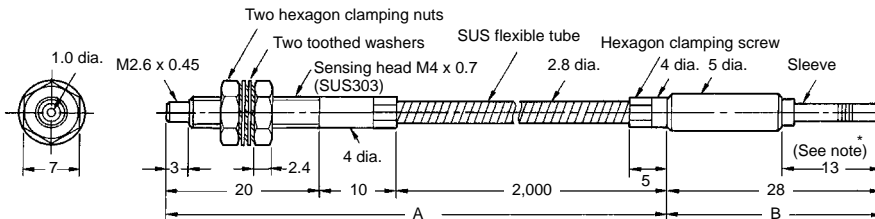



Note: Section A resists 300°C and section B (which is inserted to the Amplifier) resists 110°C. The operating temperature of the section to be inserted into the Sensor (marked with *) must be within the operating temperature range of the Amplifier.

Reflective

 Indicates models that allow free cutting. Models without this mark do not allow free cutting.

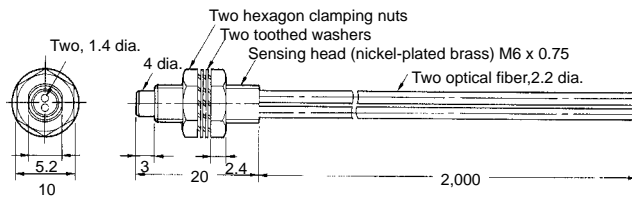
E32-D11L 



E32-D12 

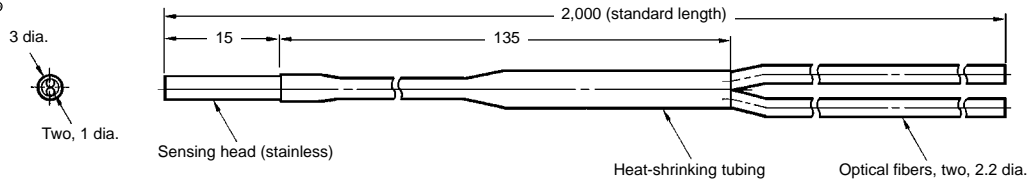

E32-D21L 

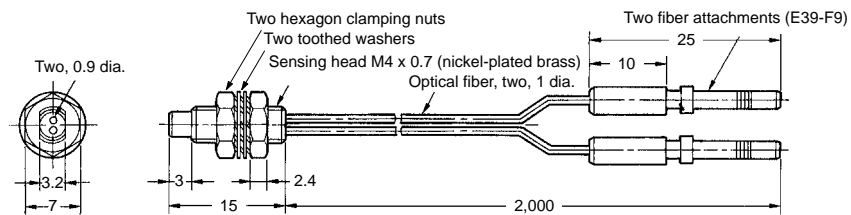

E32-D22L 

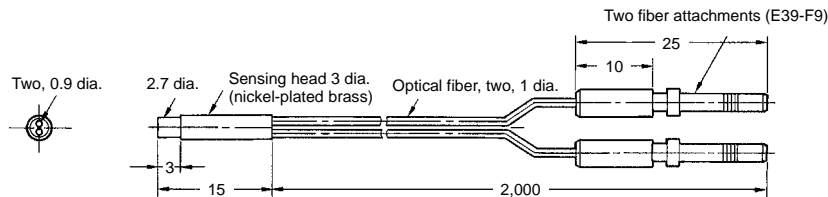

E32-DC200 

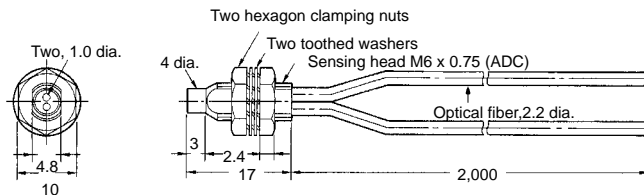

E32-DC200B
E32-DC200B4 

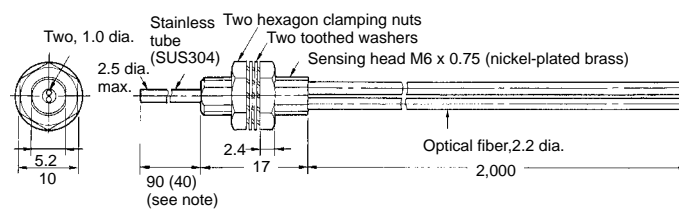

Note: The value in the parentheses is for the E32-DC200B4.

E32-DC200E 

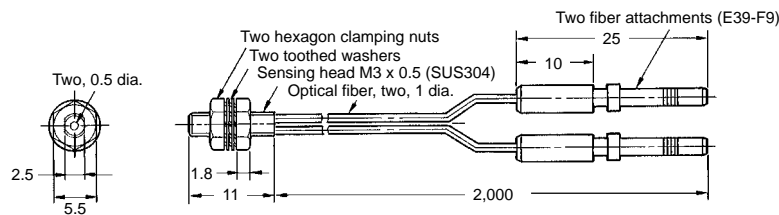

E32-DC200F
E32-DC200F4

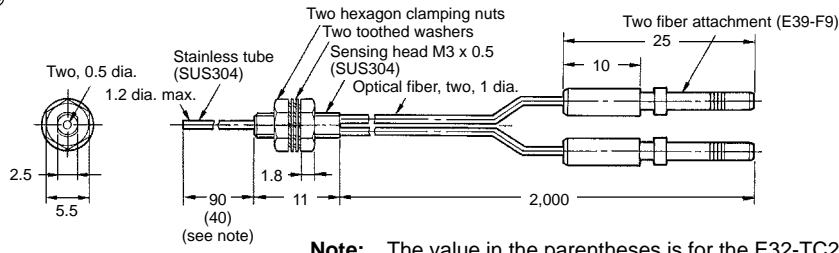

Note: The value in the parentheses is for the E32-TC200F4.

E32-D11

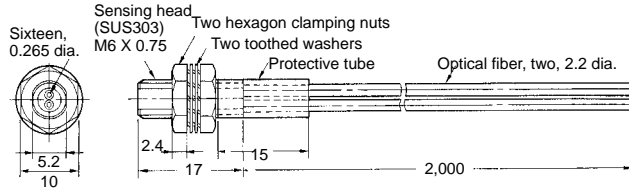

E32-D21

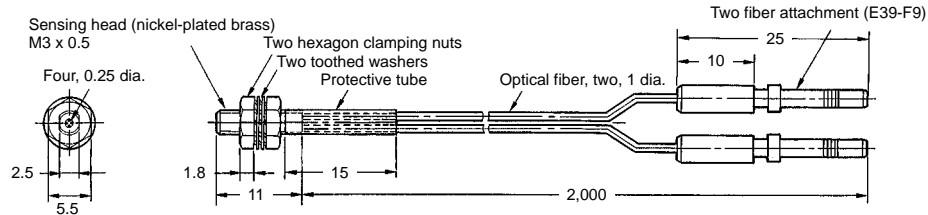

E32-D33

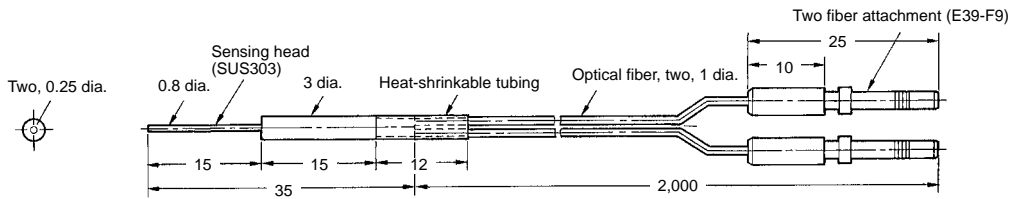

E32-CC200

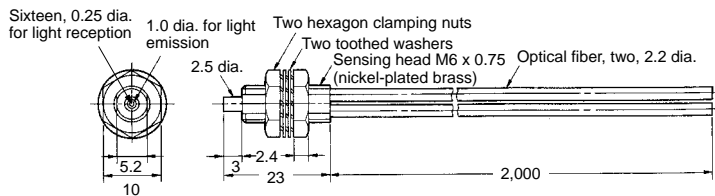

Note: The fiber for the emitter is identified by a white line.

E32-D32

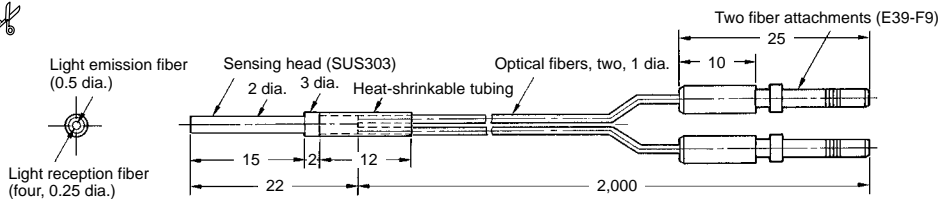

Note: The fiber for the emitter is identified by a white line.

E32-D32L

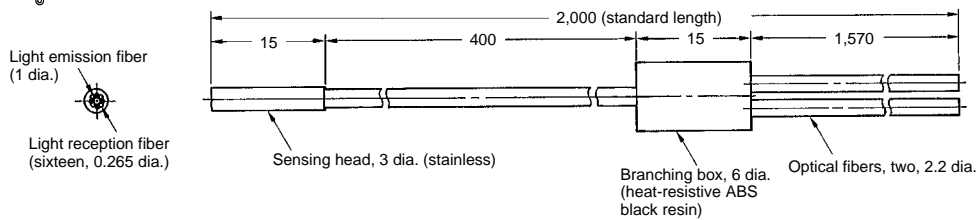

E32-D14L ✂

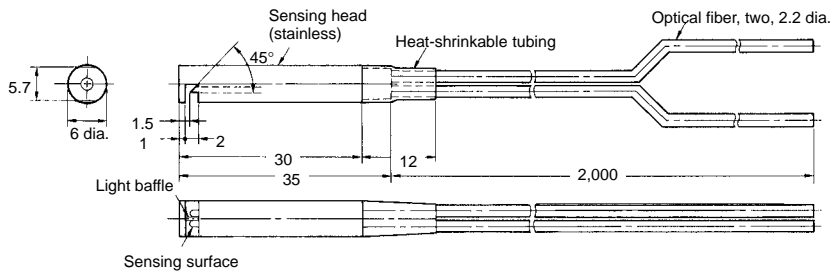

E32-D24 ✂

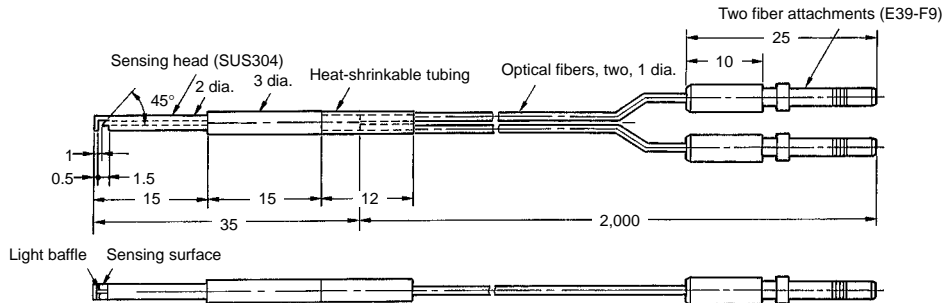

E32-D12F ✂

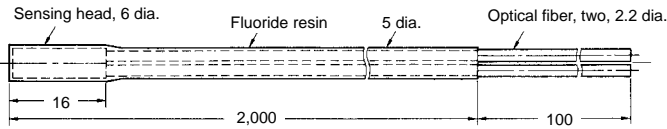

E32-D51 ✂

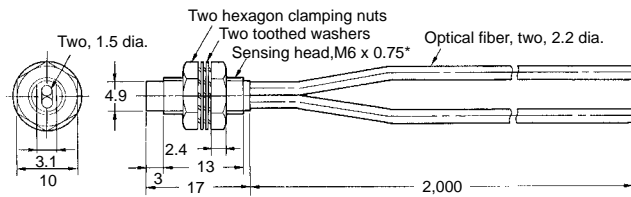

*nickel-plated brass

Note: Resistant temperature is 150°C.
Resistant temperature is 130°C when used continuously.

E32-D61

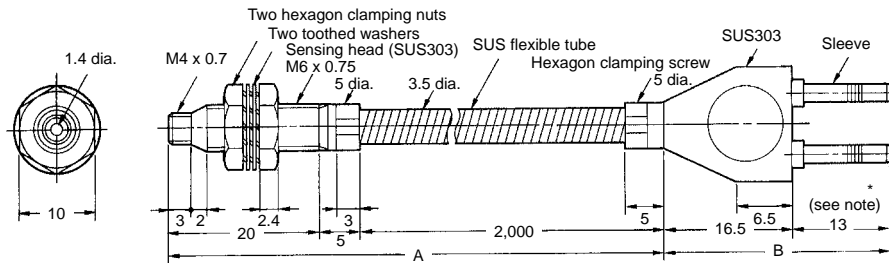

Note: Section A resists 300°C and section B (which is inserted to the Amplifier) resists 110°C. The operating temperature of the section to be inserted into the Sensor (marked with *) must be within the operating temperature range of the Amplifier.

E32-D73

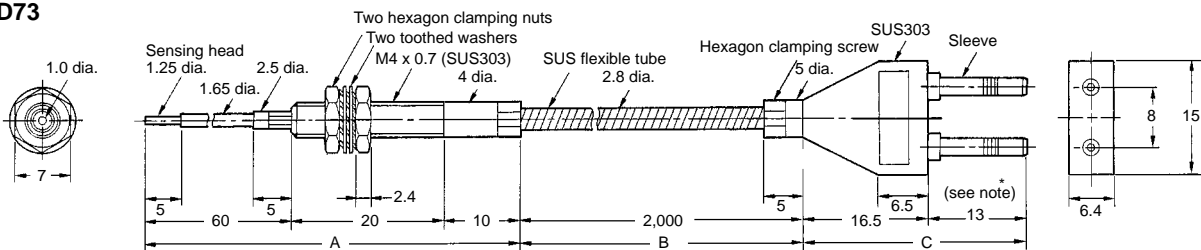

Note: Section A resists 400°C, section B resists 300°C, and section C (which is inserted to the Amplifier) resists 110°C. The operating temperature of the section to be inserted into the Sensor (marked with *) must be within the operating temperature range of the Amplifier.

E32-R21
(One E39-R3 Reflector is supplied with the Sensor)

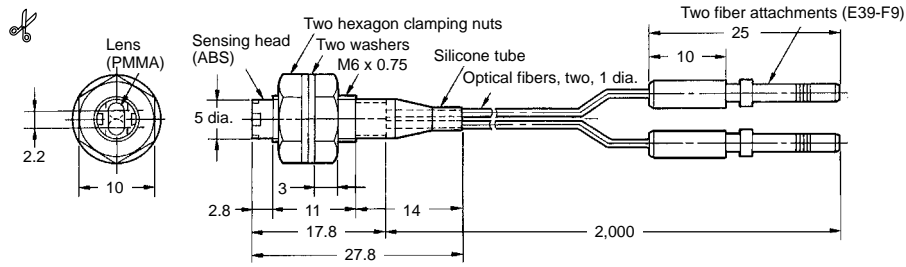

E32-R16
(One E39-R1 Reflector is supplied with the Sensor)

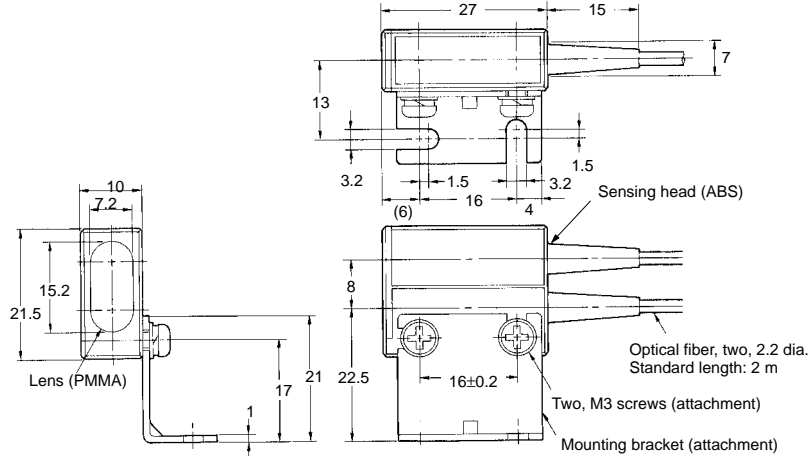

E32-L25

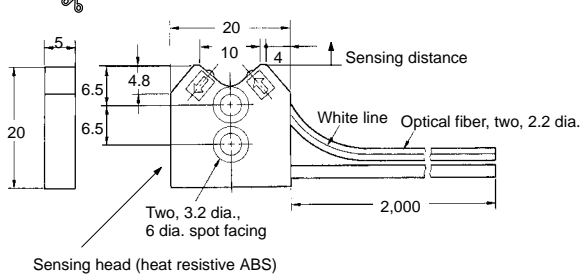

Note: The fiber for the emitter is identified by a white line.

E32-L25A

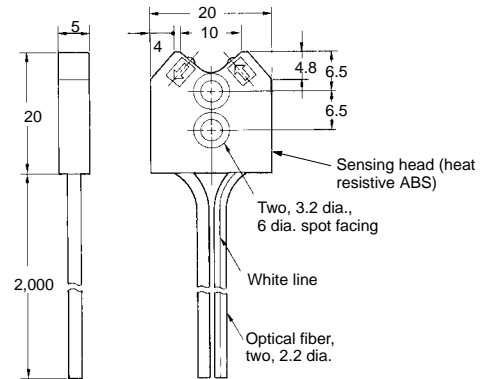

E32-L25L

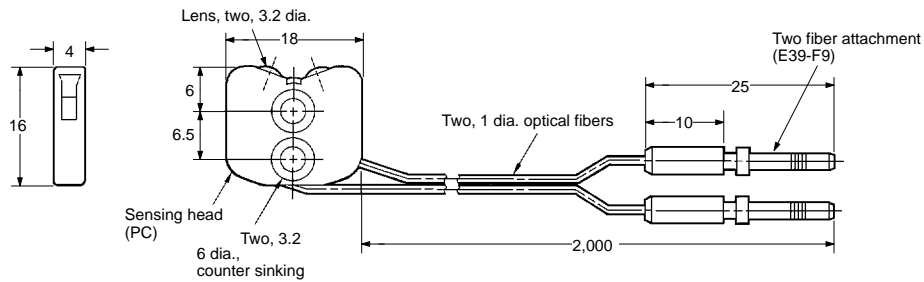

E32-L24L

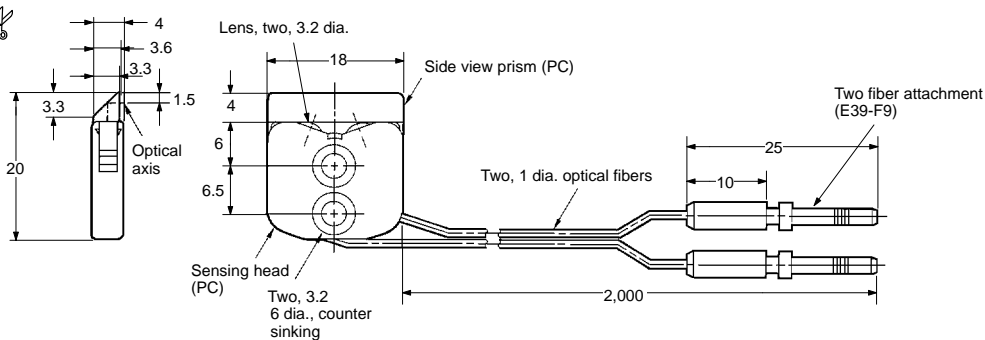

Fine Through-beam

 Indicates models that allow free cutting. Models without this mark do not allow free cutting.

E32-T22S 

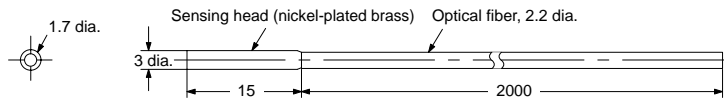

E32-T24S 

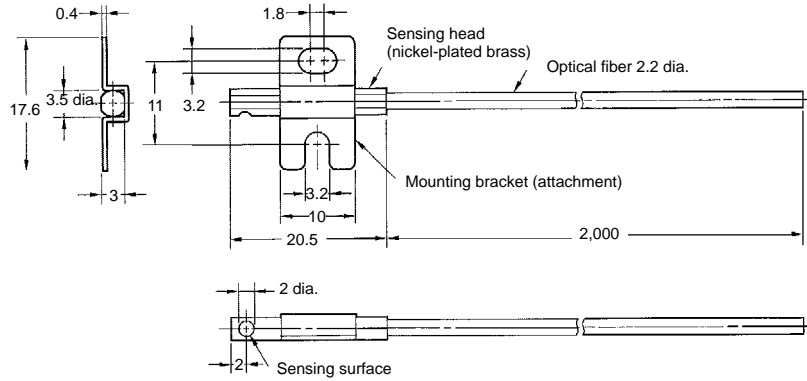

E32-T84S 

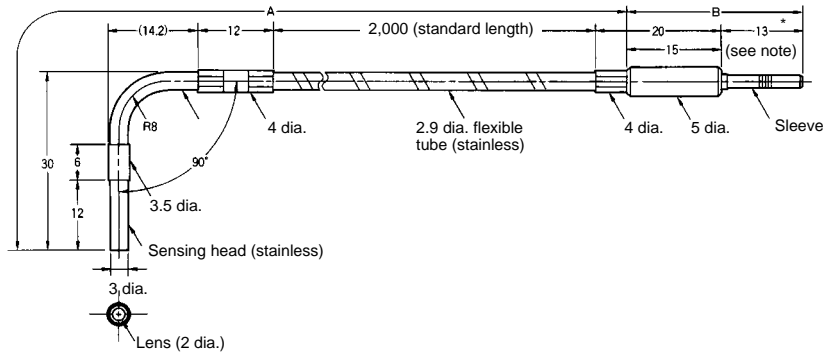

Note: Section A resists 200°C and section B (which is inserted to the Amplifier) resists 110°C. The operating temperature of section to be inserted into the Sensor (marked with *) must be within the operating temperature range of the Amplifier.

Slot Fiber Units

E32-G14 

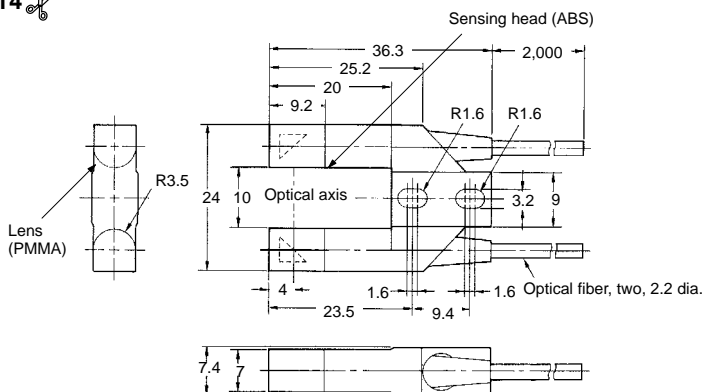

Mounting Holes

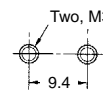

■ Reflector

Reflector (Miniature)
E39-R3



Note: Mounting bracket is attached.

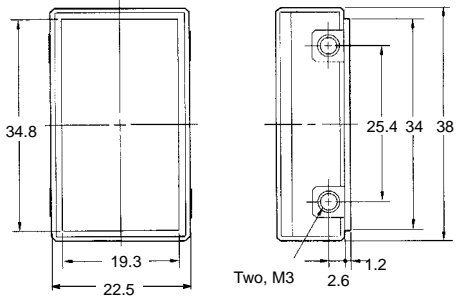

Reflector
E39-R1

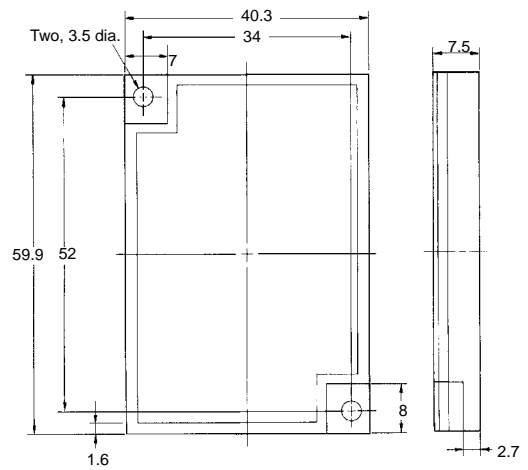

■ Attachments

E39-F1
Long Distance Lens Unit

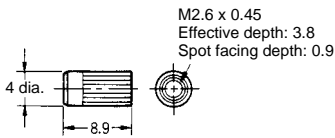

Note: One set includes two units.

E39-F2
Side-view Unit

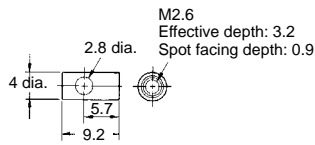

Note: One set includes two units.

E39-F3
Lens-equipped Reflective Unit

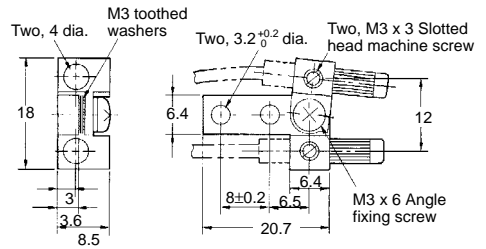

E39-F5
Side-view Reflective Unit

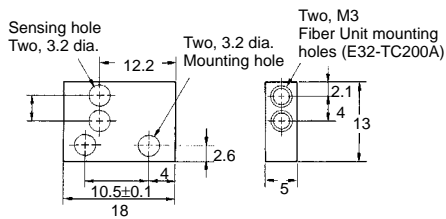

Note: When mounting, remove all of the accompanying screws first and then screw the E32-TC200A into the E39-F5 until the stopper comes into contact.

E39-F3A
Small Spot Lens Unit

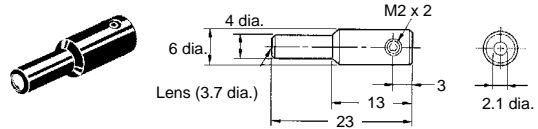

■ Protective Spiral Tubes

E39-F32A, E39-F32A5
E39-F32B, E39-F32B5

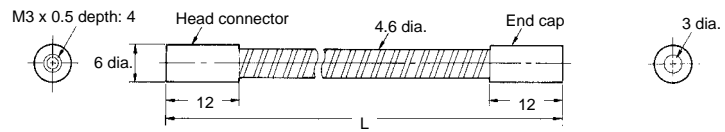
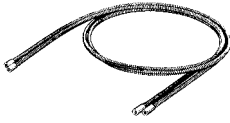

- Note:**
- L is as follows:
E39-F32A and E39-F32B: 1,000
E39-F32A5, E39-F32B5: 500
 - A pair of E39-F32A(5)'s is sold as E39-F32B(5).

E39-F32C, E39-F32C5

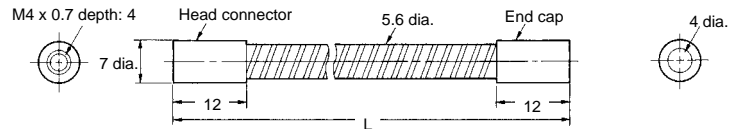

- Note:** L is as follows:
E39-F32C: 1,000
E39-F32C5: 500

E39-F32D, E39-F32D5

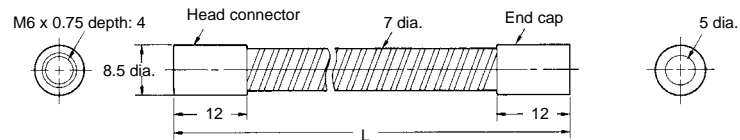
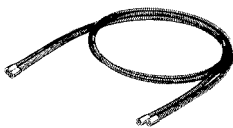

- Note:** L is as follows:
E39-F32D: 1,000
E39-F32D5: 500

■ Accessories

E39-F4 Fiber Cutter

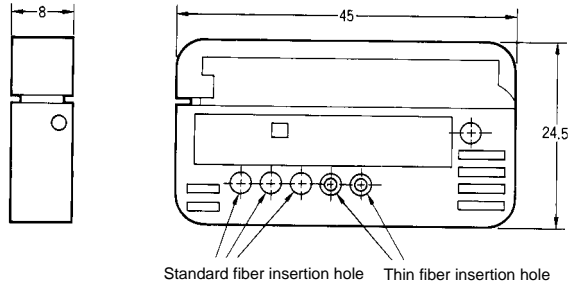
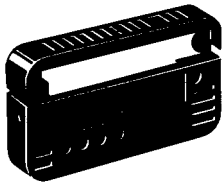

E39-F9 Attachment for Thin Fiber

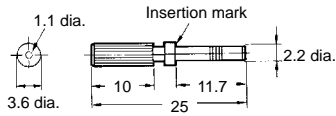
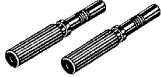

Note: One set includes two units.

E39-F10 Fiber Connector

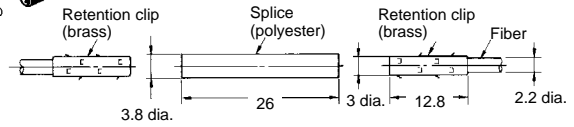
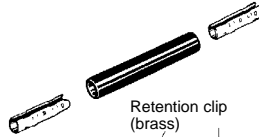

E39-G10 Protective Cover

Note: This Cover is for the E3X-NT Amplifier Unit.

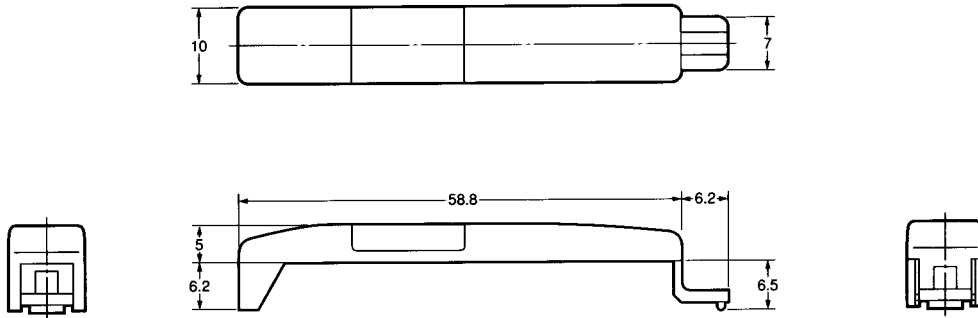

E39-G9 Protective Cover

Note: This Cover is for the E3X-NM Amplifier Unit.

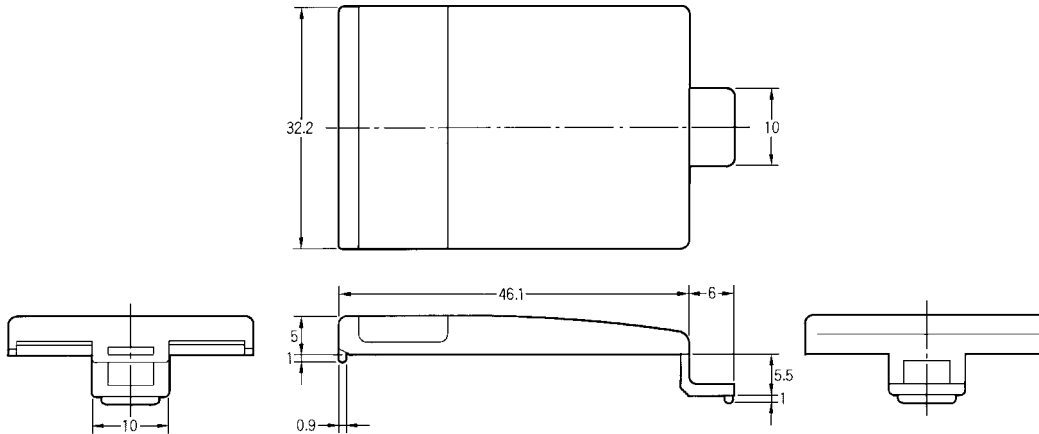

Installation

■ Connection

Connection with S3D2 Sensor Controller

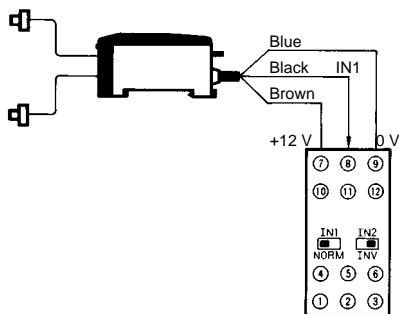

Note: A maximum of two E3X-N Sensors can be connected.

Connection with S3D8 Sensor Controller

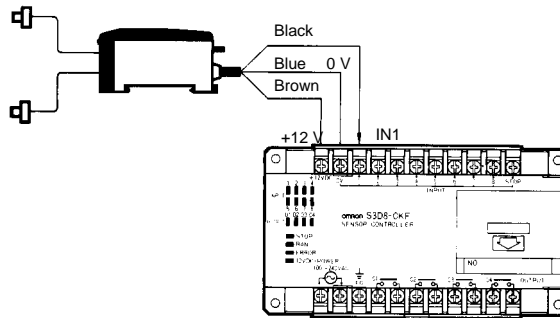

Note: 1. The E3X-N will switch to reverse operation by pressing the L Key.
2. A maximum of eight E3X-NT Sensors can be connected. (For E3X-NM, a maximum of two unit can be connected.)

Power supply voltage	Output	Functions	Model
100 to 240 VAC	Relay	AND, OR	S3D2-AK
		AND, OR, and timer	S3D2-CK
		Flip-flop	S3D2-BK
	Transistor	AND, OR, and timer	S3D2-CC
	Relay	2 inputs, 2 outputs,	S3D2-DK
		2 inputs, 2 outputs, and timer	S3D2-EK
24 VDC	Relay	AND, OR	S3D2-AKD
		AND, OR, and timer	S3D2-CKD

Precautions

■ Fiber Unit

Tightening Force

The tightening force applied to the Fiber Unit should be as follows:

Screw-mounting Model

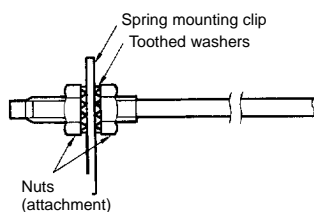

Cylindrical Model

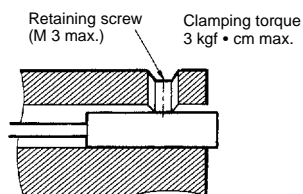

Fiber Units	Clamping torque
M3/M4 screw	0.78 N • m (8 kgf • cm)
M6 screw	0.98 N • m (10 kgf • cm)
2-mm dia. column	0.29 N • m (3 kgf • cm)
3-mm dia. column	0.29 N • m (3 kgf • cm)
E32-D14L	0.98 N • m (10 kgf • cm)
E32-T12F	0.78 N • m (8 kgf • cm)
E32-D12F	0.78 N • m (8 kgf • cm)
E32-T16	0.49 N • m (5 kgf • cm)
E32-R21	6 kgf • cm max. (0.59 N • m)
E32-M21	Up to 5 mm to the tip: 0.49 N • m (5 kgf • cm) Up to 5 mm from the tip: 0.78 N • m (8 kgf • cm)
E32-L25A	0.78 N • m (8 kgf • cm)
E32-T16P E32-T24S E32-L24L E32-L25L	0.29 N • m (3 kgf • cm)

Use a proper-sized wrench.

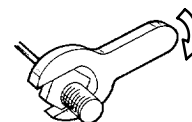

Fiber Connection and Disconnection

E3X-NT/NM/NV/NVG

The E3X-N Fiber Amplifier Unit adopts a snap-locking system. Connect or disconnect the Fiber Unit according to the following procedures:

1. Connection

• E3X-NT

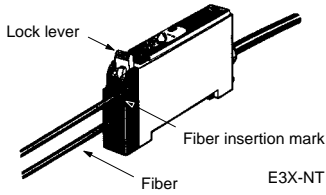

Remove the protection cover, insert the fiber into the Unit, and then lower the lock lever until a click sound is heard.

• E3X-NM

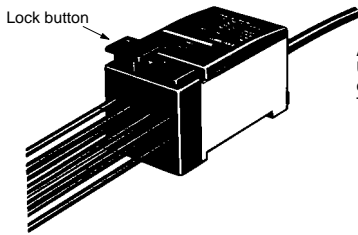

After inserting the fiber into the Unit, press the lock button until a click sound is heard. This will fix the fiber.

After cutting the fibers using the Fiber Cutter (E39-F4), place an insertion mark on the fiber so that it can be properly inserted into the Amplifier. Insert the fiber into the Amplifier up to this insertion mark.

2. Disconnection

• E3X-NT

Remove the protective cover, raise the lock lever, and then pull out the fiber.

• E3X-NM

Press the lock button again. The lock will be released and the button will pop up. Pull out the fiber. Do not forcibly pull up the lock button. (Be sure to pull out the fiber only after confirming that the lock has been released in order to maintain the fiber characteristics.)

E3X-NT

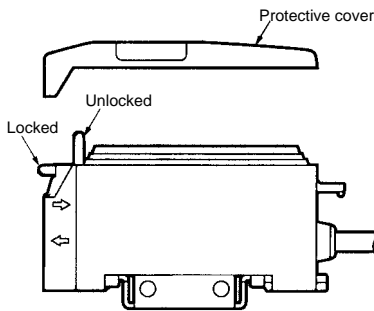

E3X-NM

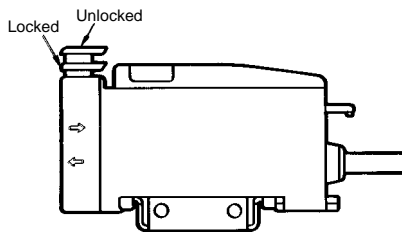

E3X-NV/NVG

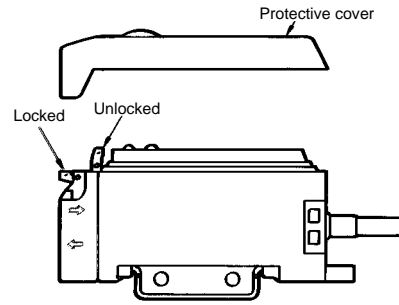

3. Precaution When Connecting or Disconnecting Fibers

Lock the fiber or release its lock under an ambient temperature range between -10°C and 40°C.

Cutting Fiber

Insert a fiber into the Fiber Cutter and determine the length of the fiber to be cut.

Press down the Fiber Cutter in a single stroke to cut the fiber.

An insertion mark can be placed on the fiber to serve as a reference when inserting the fiber into the Amplifier. Use the following procedure.

Confirm through the Cutter hole that the fiber is inserted beyond the insertion mark hole so that the insertion mark is properly indicated and then press firmly down on the Cutter.

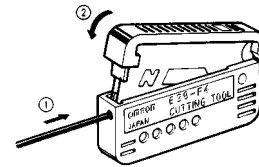

Insert the fiber into the Amplifier up to the insertion mark. Proper fiber performance will not be achieved unless the fiber is inserted all the way to the insertion mark. (This method is applicable to standard, 2.2-mm-diameter fibers only.)

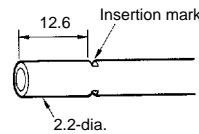

The cutting holes cannot be used twice. If the same hole is used twice, the cutting face of the fiber will be rough and the sensing distance will be reduced. Always use an unused hole.

Use either one of the two holes on the right (refer to the following figure) to cut a thin fiber as follows:

1. An attachment is temporarily fitted to a thin fiber before shipment.

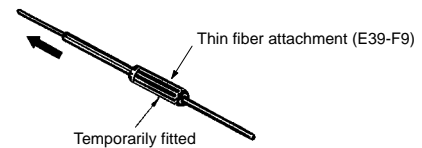

2. Secure the attachment after adjusting the position of it in the direction indicated by the arrow.



3. Insert the fiber into the E39-F4 to cut.

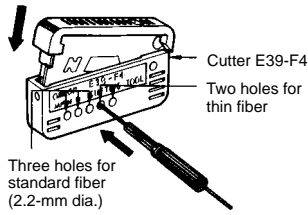

4. Finished state (proper cutting state).

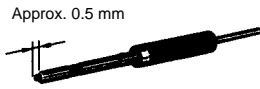

Note: Insert the fiber in the direction indicated by the arrow.

Connection

Do not pull or press the Fiber Units. The Fiber Units have a withstand force of 1 kgf or 3 kgf max. (pay utmost attention because the fibers are thin).

Do not bend the Fiber Units beyond the permissible bending radius. Do not bend the edge of the Fiber Units.

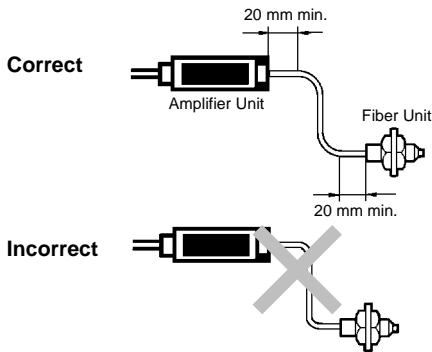

Do not apply excess force on the Fiber Units.

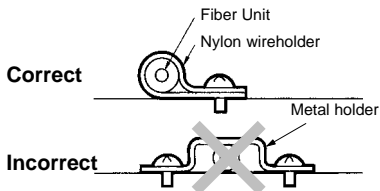

The Fiber Head could be broken by excessive vibration. To prevent this, the following is effective:

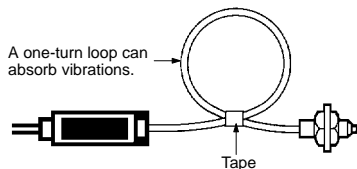

Bending Radius

E39-F11 Sleeve Bender

The bending radius of the stainless tube should be as large as possible. The smaller the bending radius becomes, the shorter the sensing distance will be.

Insert the tip of the stainless sleeve to the Sleeve Bender and bend the stainless sleeve slowly along the curve of the Sleeve Bender (refer to the figure).

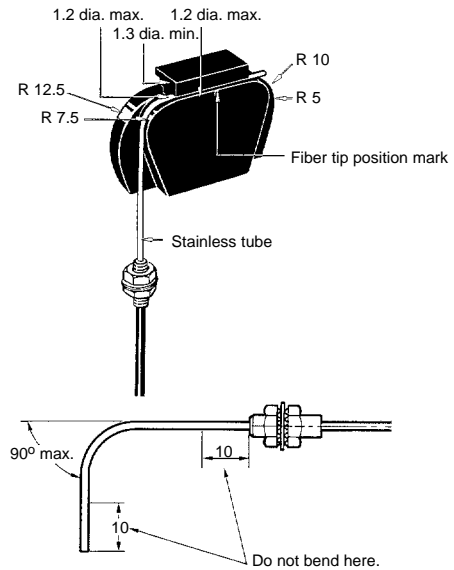

Handling

E32-D51/-T51 Heat-resistant Fiber

The bending radius of the fibers should be 35 mm min.

Connecting fibers via the E39-F10 Fiber Connector is not possible. The withstand temperature of the Heat-resistant Fibers is 150°C max. In continuous operation, the ambient temperature should be 130°C max.

E32-T14/-G14

If the Sensor is ON because some object in front of the lenses reflects light, attach the black seals (sold together) to the lenses.

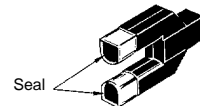

E32-L25 (A) Wafer Sensor

Insert the fiber with a white line into the light emission side of the Amplifier.

The tightening force of the sensor head is 8 kgf • cm max. (0.75 N • m).

Avoid places where water could be sprayed onto the E32-L25(A).

E32-T16/-T16P Slit Seal (Attachment)

Peel the E32-T16 Slit Seal off the ground paper and affix the Slit Seal to the sensing face of the Sensor so that the corners of the Slit Seal fit in with the corners of the sensing face. To detect an object at a distance of 45 cm max., a 0.5-mm wide Slit Seal must be used.

E32-T16 Sensing Head

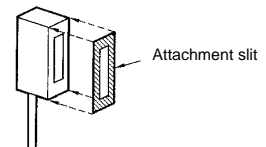

E32-M21

The four fibers must be separated so that there will be no mutual interference.

■ Amplifier Units

Mounting

Mounting

1. Mount the front part on the mounting bracket (attachment) or a DIN track.
2. Press the back part onto the mounting bracket or the DIN track.

Note: Do not mount the back part onto the mounting bracket or the DIN track first and then mount the front part on the mounting bracket or the DIN track, or the mounting strength of the Amplifier Unit may decrease.

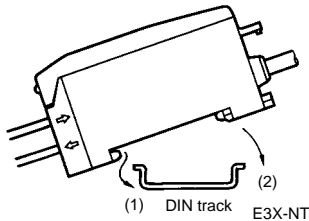

Dismounting

By pressing the Amplifier Unit in direction (3) and lifting the fiber insertion part in direction "4" as shown in the following, the Amplifier can be dismantled with ease.

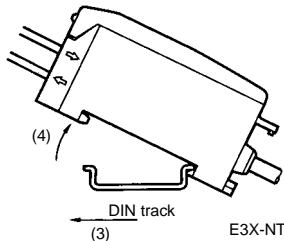

In the case of side mounting, attach the mounting bracket on the Amplifier first, and secure the Amplifier with M3 screws and washers. The diameter of the washers should be 6 mm max.

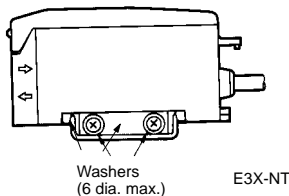

Turning Power On

After the E3X-N° is turned on, the E3X-N° will be ready to operate in 100 ms maximum. If power is supplied to the E3X-N° and the load is connected to the E3X-N° independently, be sure to turn on the power supply connected to the E3X-N° first.

Output Short-circuit Protection

When the E3X-N° is turned on or off, no control output will be ON, even though the operation indicator of the E3X-N° will be lit for an instant. If the short-circuit protection function of the E3X-NM (four channels) is activated, none of the four channels will have any output.

Unused Channels of E3X-NM (Four Channels)

Unused channel protection seals are provided with the E3X-NM. If all the four channels are not used (e.g., if only three channels are used), paste an unused channel protection seal to the fiber insertion hole.

Mutual Interference Protection Function

In principle, use the E3X-NM (four channels) for the close connection of a maximum of four Fiber Units.

When closely connecting two to three Fiber Units to more than one E3X-NT (one channel), perform with/without-object teaching, in which case teaching must be performed on a single E3X-NT at a time. Therefore, turn on only the E3X-NT on which teaching is performed. If all the E3X-NTs are turned on, interrupt the emitters of the Fiber Units on which teaching is not performed.

EEPROM Writing Error

Power interruptions or noise caused by static electricity or other causes can result in write errors during any part of the teaching process from teaching initial operating levels without a workpiece to final compensations. These errors include buzzers, lighting of teaching indicators, simultaneous flashing of read/green indicators, lighting of operation indicators, and lighting or flashing of stability indicators. If any of these occur, re-input teaching using the teaching button on the Amplifier.

Others

When power is off:

The moment power is turned off, the E3X-N° could output a pulse signal which could affect the operation of the devices connected to it. This will happen more often if power is supplied to the E3X-N° from an external power supply, thus affecting the connected timer and counter. Use a built-in power supply as much as possible to avoid this.

In the case of the cord is extended, use a wire with 0.3 mm² min. The total length of the cord should be 100 m max.

Power supply:

If a standard switching regulator is used as a power supply, the frame ground (FG) terminal and the ground (G) terminal must be grounded, or otherwise the E3X-N° can malfunction, influenced by the switching noise of the power supply.

The supplied voltage must be within the rated voltage range. Unregulated full- or half-wave rectifiers must not be used as power supplies.

Do not lay wiring to the Optical Sensor together with power lines in the same piping or ducts. Doing so will cause induction between the lines, possibly resulting in faulty operation or destruction. Always lay wiring to the Optical Sensor in separate or dedicated piping.

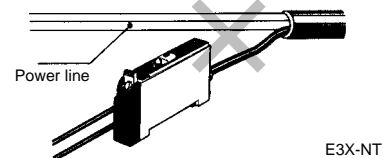

■ Attachment Units

Applications

E39-F10 Fiber Connector

Use the following procedure (refer to the figure) to connect fibers via the Fiber Connector.

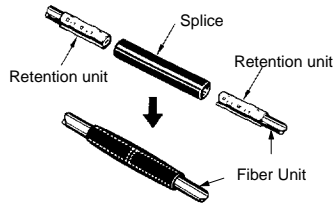

Each Fiber Unit should be as close as possible before they are connected.

Sensing distance will be reduced by approximately 25% when fibers are connected.

Only fibers with 2.2-mm dia. can be connected.

Protective Spiral Tube

Insert a fiber into the Protective Spiral Tube from the head connector side (screwed) of the tube.

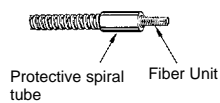

Push the fiber into the Protective Spiral Tube. The tube should be straight so that the fiber is not twisted when inserted. Then turn the end cap of the spiral tube.

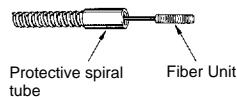

Secure the Protective Spiral Tube on a suitable place with the attached nut.

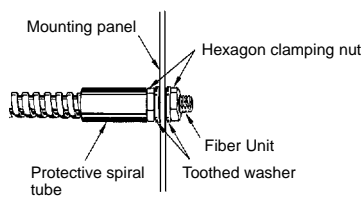

Use the attached saddle to secure the end cap of the Protective Spiral Tube. To secure the Protective Spiral Tube at a position other than the end cap, apply tape to the tube so that the portion becomes thicker in diameter.

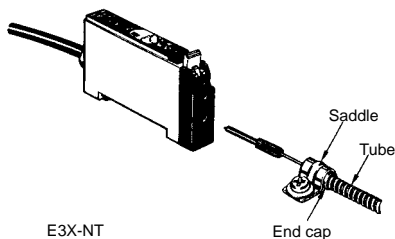

! WARNING

The E3X-N is not a safety component for ensuring the safety of people as defined in EC Directive 91/368/EEC, or as covered by separate European standards or by any other regulations or standards.

ALL DIMENSIONS SHOWN ARE IN MILLIMETERS.

To convert millimeters into inches, multiply by 0.03937. To convert grams into ounces, multiply by 0.03527.

Cat. No. E233-E1-5 **In the interest of product improvement, specifications are subject to change without notice.**

OMRON Corporation

Industrial Sensors Division
Sensing Devices and Components Division H.Q.
28th Fl., Crystal Tower Bldg.
1-2-27, Shiromi, Chuo-ku,
Osaka 540-6028 Japan
Phone: (81)6-949-6012 Fax: (81)6-949-6021

Printed in Japan
0698-2M (1194) Ⓐ