

3-Terminal 1 Amp Adjustable Voltage Regulator

Features

- Typical 1% Output Voltage Tolerance
- Typical 0.01%/V Line Regulation
- Typical 0.2% Load Regulation
- Very Low Dropout Voltage: 1.2V at 1A Output Current
- Trimmed Current Limit
- On-chip Thermal Protection
- Operation Junction Temperature: 0 to 125°C
- Available in RoHS Compliant, Lead Free Packaging

TO-220 Package

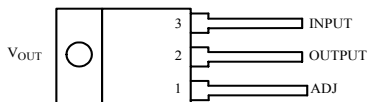

Applications

- PC Motherboard
- LCD Monitor
- Graphics Card
- DVD Player
- Network Interface Card/Switch
- Telecom Equipment
- Printer and other Peripheral Equipment

General Description

The SP317 is an adjustable three-terminal positive voltage regulator with a very low dropout of 1.2V at 1A output current. Using 2 external resistors, the SP317 can provide an adjustable output voltage down to 1.25V.

The SP317 includes a circuit of trimmed bandgap reference to assure output voltage accuracy to be within 1%. It also provides current limiting and thermal shutdown. The current limit is trimmed to ensure specified output current and controlled short-circuit current. The On-chip thermal limiting provides protection against any combination of overload and ambient temperature that would create excessive junction temperature.

The SP317 is available in the standard SOT-223, TO-220, TO-252 and TO-263 power packages.

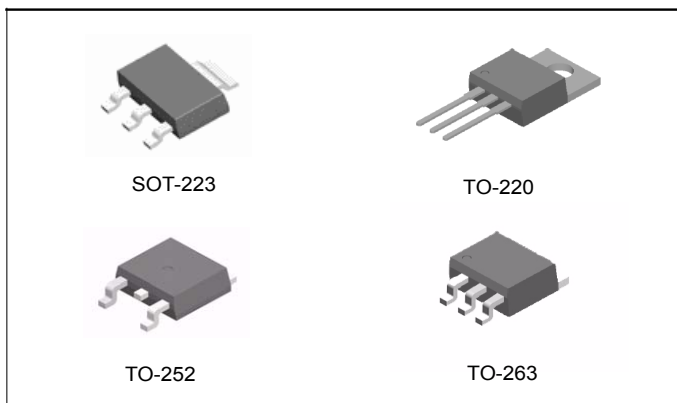

Figure 1. Package Types of SP317

Pin Configuration

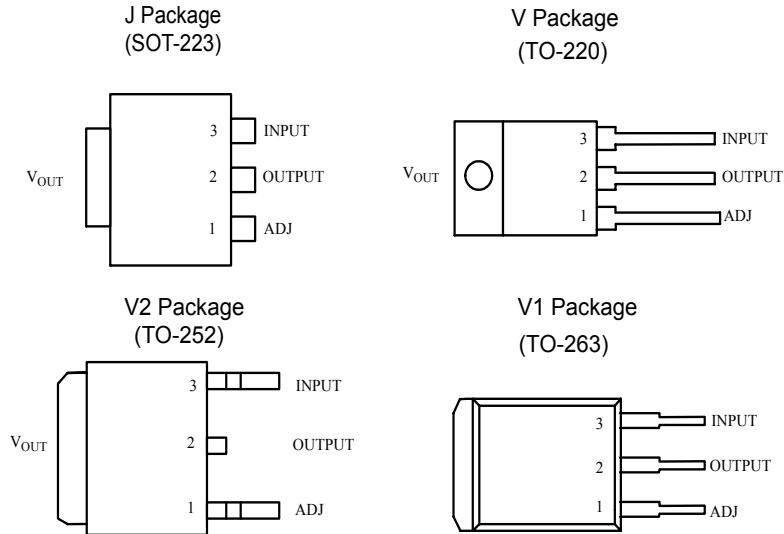

Figure 2. Pin Configuration of SP317 (Top View)

Functional Block Diagram

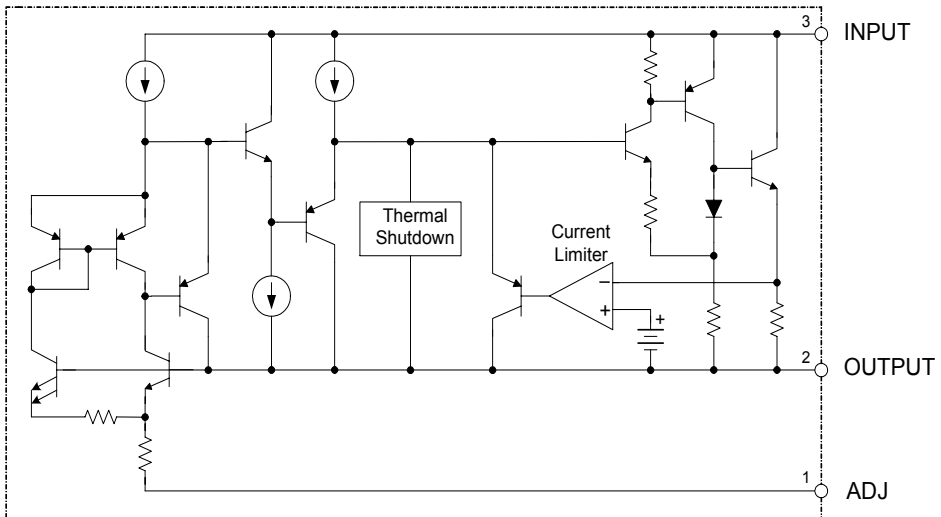

Figure 3. Functional Block Diagram of SP317

Absolute Maximum Ratings (Note 1)

Parameter	Symbol	Min	Max	Unit
Input Voltage	V_{IN}		20	V
Maximum Junction Temperature	T_J		150	°C
Storage Temperature	T_S	-65	150	°C
Lead Temperature (Soldering, 10sec)	T_{LEAD}		300	°C
ESD (Human Body Model)	ESD		4000	V

Note1: Stresses greater than those listed under "Absolute Maximum Ratings" may cause permanent damage to the device. These are stress ratings only, and functional operation of the device at these or any other conditions beyond those indicated under "Recommended Operating Conditions" is not implied. Exposure to "Absolute Maximum Ratings" for extended periods may affect device reliability.

Recommended Operating Conditions

Parameter	Symbol	Min	Max	Unit
Input Voltage	V_{IN}	$V_{OUT}+2$	15	V
Operating Junction Temperature Range	T_J	0	125	°C

Electrical Characteristics

(Typicals and limits apply for $T_J = 25^\circ\text{C}$, $P \leq$ Maximum Power Dissipation unless otherwise specified.)(Note 2)

Parameter	Symbol	Conditions	Min	Typ	Max	Unit
Reference Voltage	V_{REF}	$10\text{mA} \leq I_{OUT} \leq 1\text{A}$, $3\text{V} \leq (V_{IN} - V_{OUT}) \leq 10\text{V}$	1.20	1.25	1.30	V
Line Regulation	S_V	$I_{OUT} \leq 20\text{mA}$, $3\text{V} \leq V_{IN} - V_{OUT} \leq 10\text{V}$		0.01	0.04	%/V
Load Regulation	S_I	$V_{IN} - V_{OUT} = 2\text{V}$, $10\text{mA} \leq I_{OUT} \leq 1\text{A}$		0.2	0.4	%
Thermal Regulation		20ms Pulse		0.04	0.07	%/W
Dropout Voltage	ΔV	$I_{OUT} = 1\text{A}$		1.2	1.3	V
Current Limit	I_{LIMIT}	$(V_{IN} - V_{OUT}) = 2\text{V}$	1.2	1.5	1.8	A
Adjust Pin Current				50	100	μA
Adjust Pin Current Change		$1.4\text{V} \leq (V_{IN} - V_{OUT}) \leq 10\text{V}$, $10\text{mA} \leq I_{OUT} \leq 1\text{A}$		0.2	5	μA
Minimum Load Current		$3\text{V} \leq (V_{IN} - V_{OUT}) \leq 15\text{V}$		3.5	10	mA
Ripple Rejection		$f = 120\text{Hz}$, $C_{OUT} = 1\mu\text{F}$ Tantalum, $(V_{IN} - V_{OUT}) = 3\text{V}$, $I_{OUT} = 1\text{A}$	60	75		dB
Temperature Stability				1		%
Long -Term Stability		$T_A = 125^\circ\text{C}$, 1000hrs		0.3		%
RMS Output Noise (% of V_{OUT})		$T_A = 25^\circ\text{C}$, $10\text{Hz} \leq f \leq 10\text{kHz}$		0.003		%
Thermal Resistance, Junction to Case		SOT-223 TO-252 TO-220 TO-263		15 10 4.5 4		$^\circ\text{C}/\text{W}$
Thermal Shutdown		Junction Temperature		150		$^\circ\text{C}$
Thermal Shutdown Hysteresis				25		$^\circ\text{C}$

Note 2: Maximum Power Dissipation is Package Type and Case Temperature dependent. Please see Figure 12.

Typical Performance Characteristics

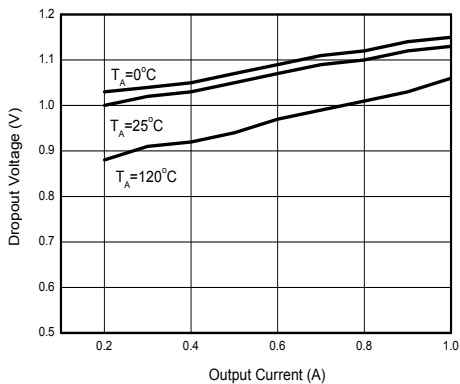

Figure 5. Dropout Voltage vs. Output Current

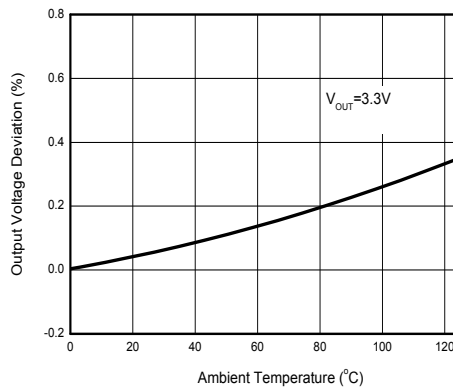

Figure 6. Load Regulation vs. Temperature

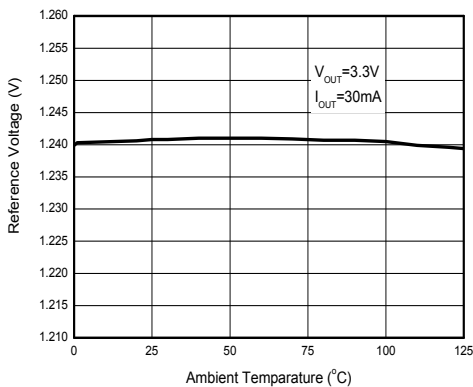

Figure 7. Reference Voltage vs. Temperature

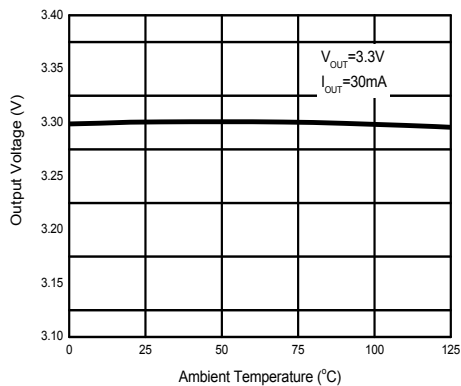

Figure 8. Output Voltage vs. Temperature

Typical Performance Characteristics (Continued)

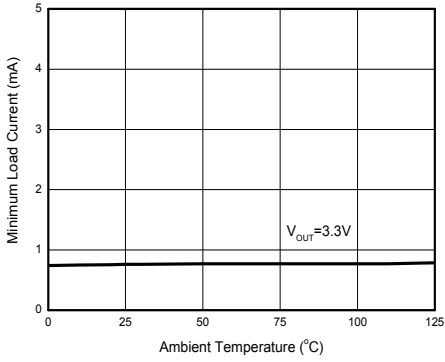

Figure 9. Minimum Load Current vs. Temperature

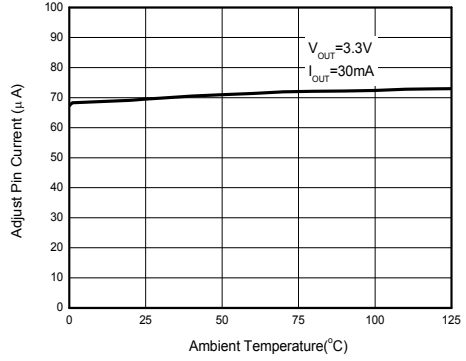

Figure 10. Adjust Pin Current vs. Temperature

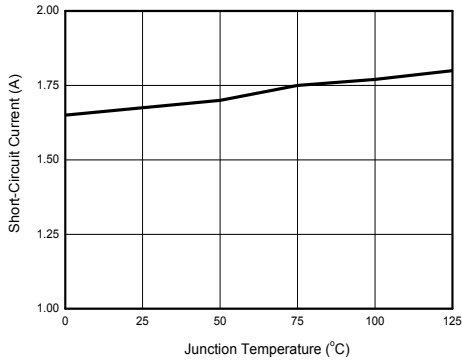

Figure 11. Short-Circuit Current vs. Temperature

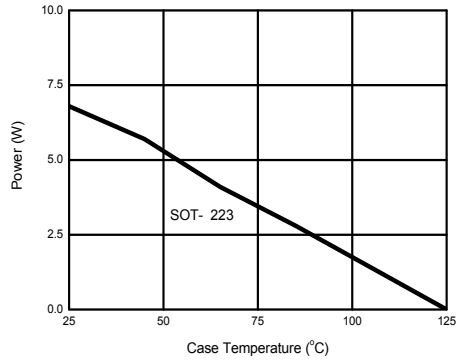

Figure 12. Maximum Power Dissipation

Typical Performance Characteristics (Continued)

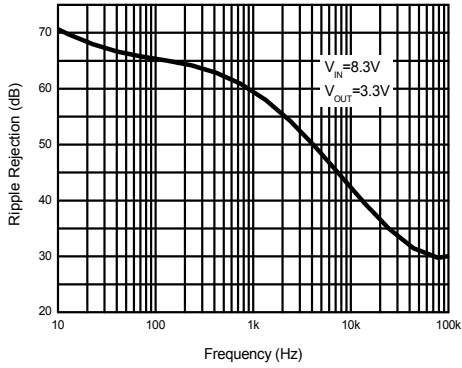

Figure 13. Ripple Rejection vs. Frequency

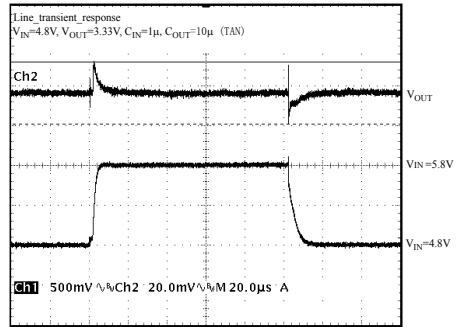

Figure 14. Line Transient Response

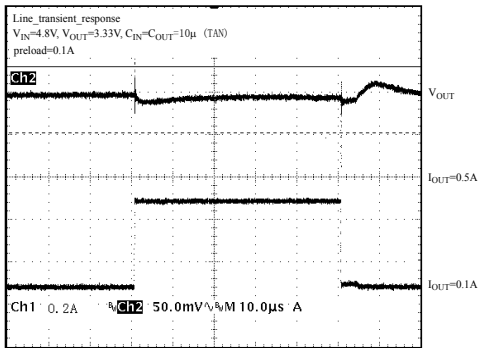

Figure 15. Load Transient Response

Typical Application

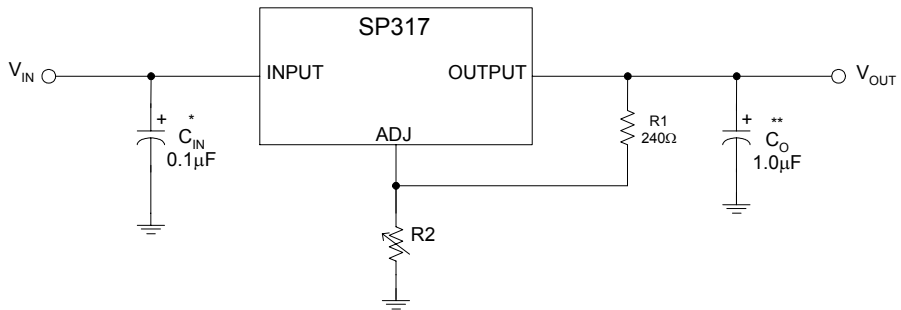

Figure 4. Typical Application of SP317

* = C_{IN} is required if the regulator is located near power supply filter.

**= C_O is needed for stability and it improves transient response.

$$V_{OUT} = V_{REF} \times (1 + R2/R1) + I_{ADJ} \times R2$$

Since I_{ADJ} is controlled to less than 100 μ A, the error associated with this term is negligible in most applications.

Mechanical Dimensions

SOT-223

Unit: mm(inch)

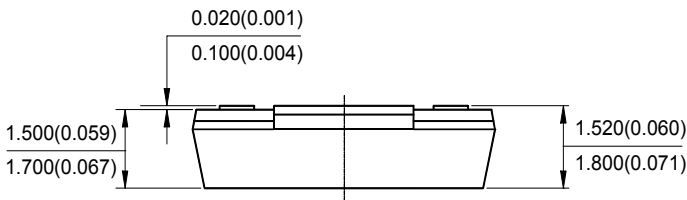
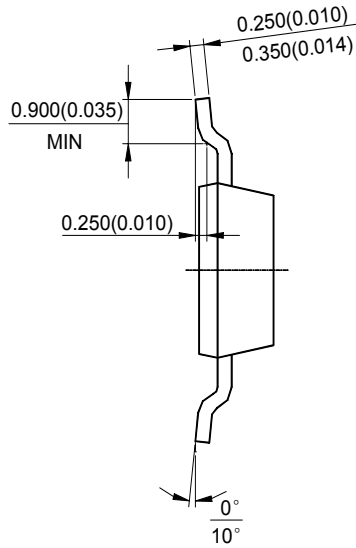
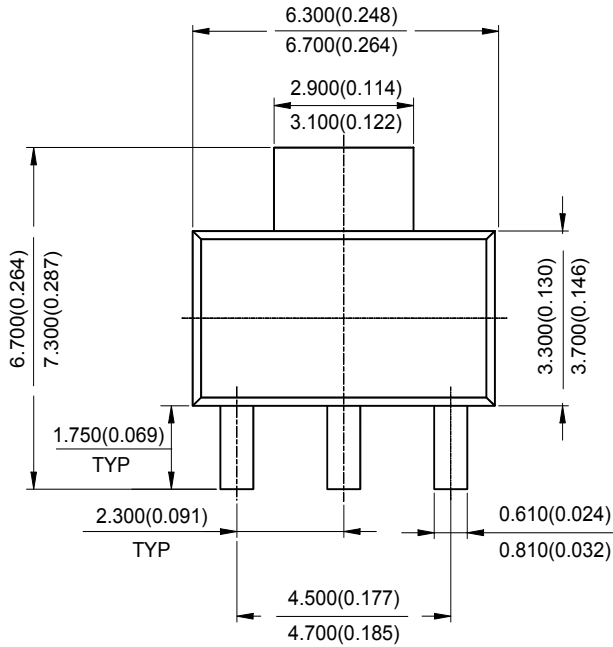

Mechanical Dimensions (Continued)

TO-220

Unit: mm(inch)

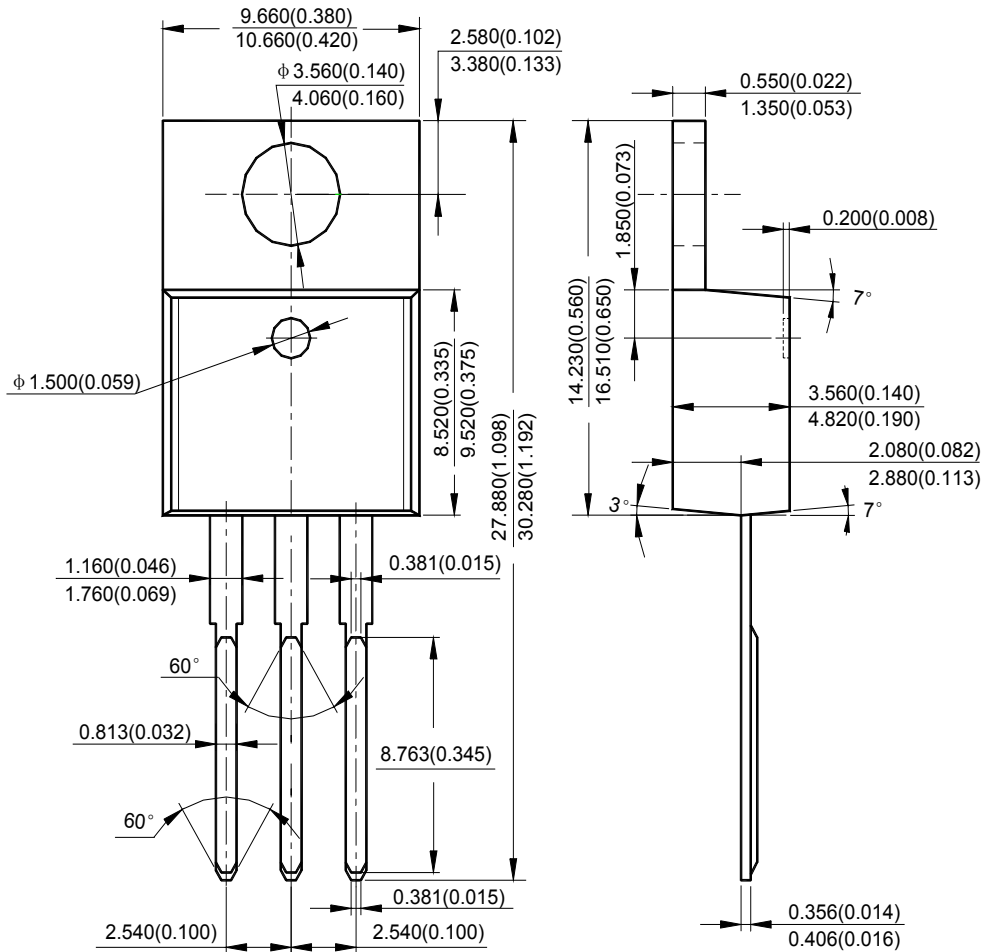

Mechanical Dimensions (Continued)

TO-252

Unit: mm(inch)

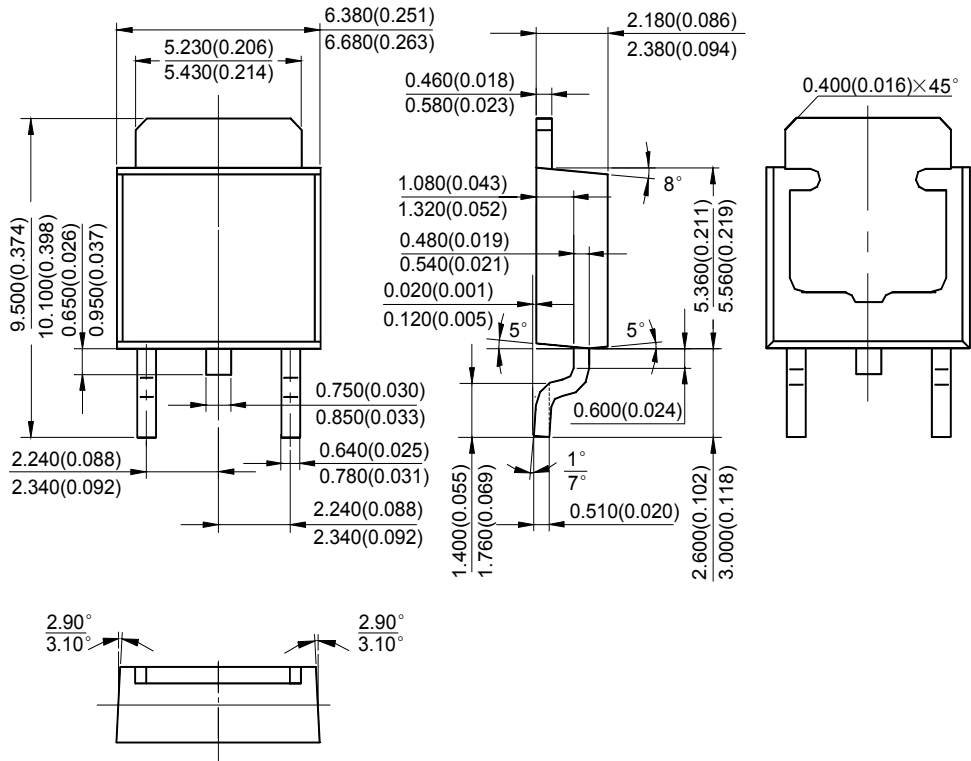

Mechanical Dimensions (Continued)

TO-263

Unit: mm(inch)

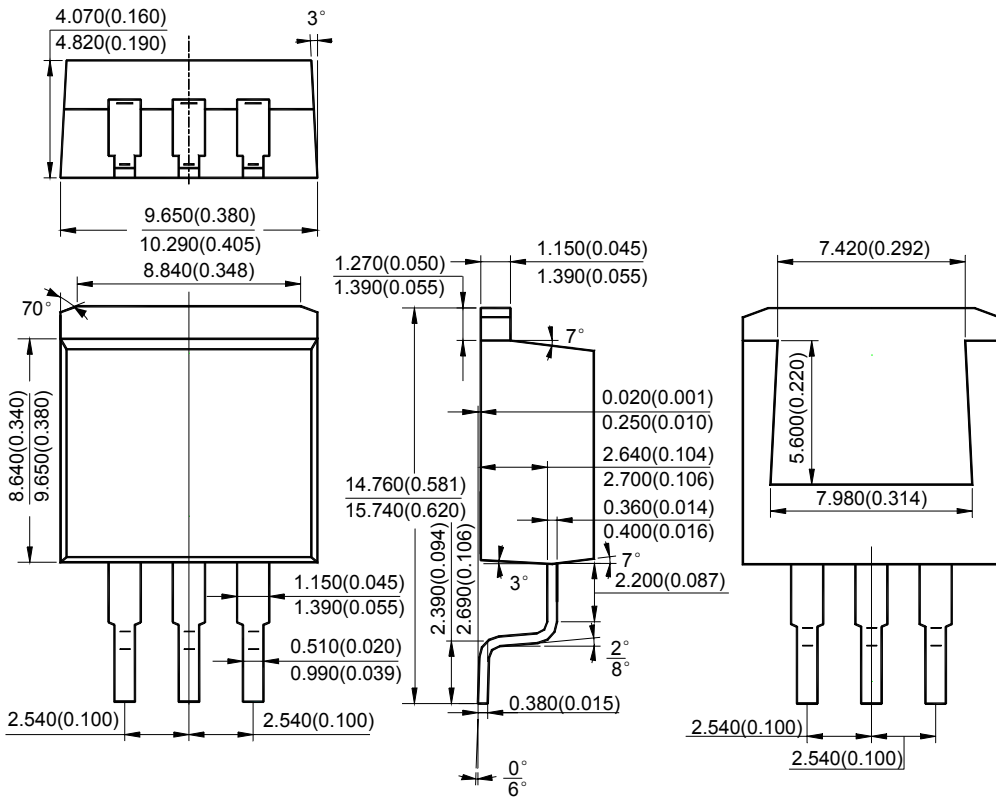

SP317
 Part Name _____ /TR: Tape and Reel
 _____ Blank: Tube
 Package _____ -L: Lead Free and
 _____ RoHS Compliant
 J: SOT-223
 V: TO-220
 V2: TO-252
 V1: TO-263

Part Number	Temperature Range	Voltage Tolerance	Output Voltage	Package	Pin Count	Packing Type
SP317J-L/TR	0°C to +125°C	1.0%	Adj	SOT-223	3	2,500/TR
SP317V-L	0°C to +125°C	1.0%	Adj	TO-220	3	50/TUBE
SP317V2-L/TR	0°C to +125°C	1.0%	Adj	TO-252	3	2,500/TR
SP317V1-L/TR	0°C to +125°C	1.0%	Adj	TO-263	3	800/TR



Sipex Corporation

**Headquarters and
 Sales Office**
 233 South Hillview Drive
 Milpitas, CA 95035
 TEL: (408) 934-7500
 FAX: (408) 935-7600

Sipex Corporation reserves the right to make changes to any products described herein. Sipex does not assume any liability arising out of the application or use of any product or circuit described herein; neither does it convey any license under its patent rights nor the rights of others.