

Performance Parameters 1ML06-023-XXt

Type	$\Delta T_{max}$ K	$Q_{max}$ W	$I_{max}$ A	$U_{max}$ V	AC R Ohm	H mm	h mm
1ML06-023-xxt (N=23) Al <sub>2</sub> O <sub>3</sub> 0.25mm ceramics version							
1ML06-023-05t	69	5.2	3.4	2.8	0.68	1.2	0.5
1ML06-023-07t							
1ML06-023-09t	71	3.1	2.0		1.20	1.6	0.9
1ML06-023-12t	71	2.3	1.5		1.60	1.9	1.2

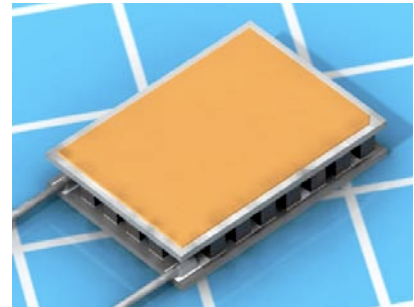

Performance data are given at 300K, vacuum

Technical Drawing

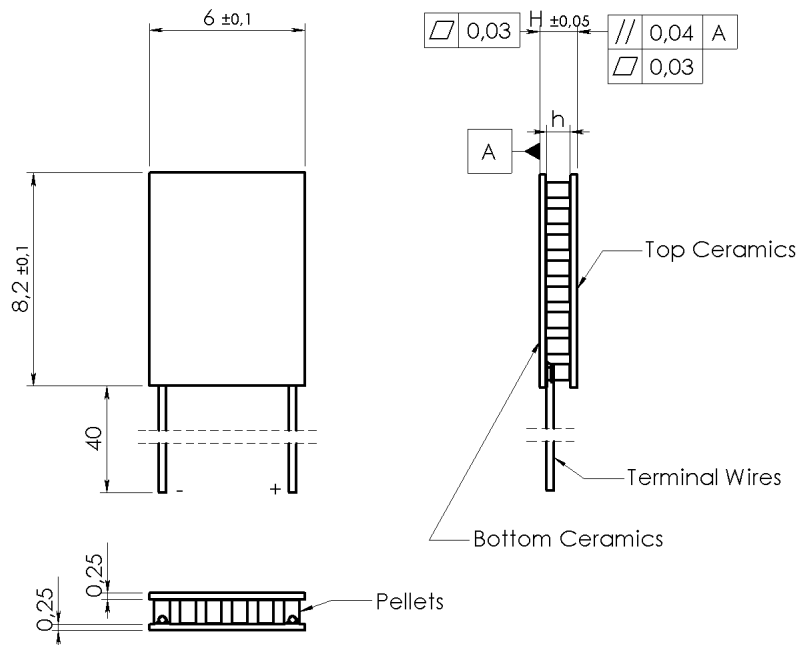

Options available

**A. TEC Assembly:**

Solder Sn-Sb (T<sub>melt</sub>=230°C)

**B. Ceramics:**

1. Pure Al<sub>2</sub>O<sub>3</sub> (100%)
2. Alumina (Al<sub>2</sub>O<sub>3</sub> - 96%)
3. Aluminum Nitride (AlN)

100% Al<sub>2</sub>O<sub>3</sub> used as standard

**C. Ceramics Surface Options**

1. Blank ceramics
2. Metallized:
  - 2.1 Ni / Sn(Bi)
  - 2.2 Gold plating
3. Metallized and pre-tinned:
  - 3.1 Solder 94 (Pb-Sn-Bi, T<sub>melt</sub>=94°C)
  - 3.2 Solder 117 (In-Sn, T<sub>melt</sub>=117°C)
  - 3.3 Solder 138 (Sn-Bi, T<sub>melt</sub>=138°C)
  - 3.4 Solder 183 (Pb-Sn, T<sub>melt</sub>=183°C)

**D. Thermistor (optional)**

Can be mounted to cold side ceramics edge. Calibration is available.

**E. Terminal wires**

1. Pre-tinned Copper
2. Insulated Wires
3. Insulated Color Coded

Performance Plots 1ML06-023-05t

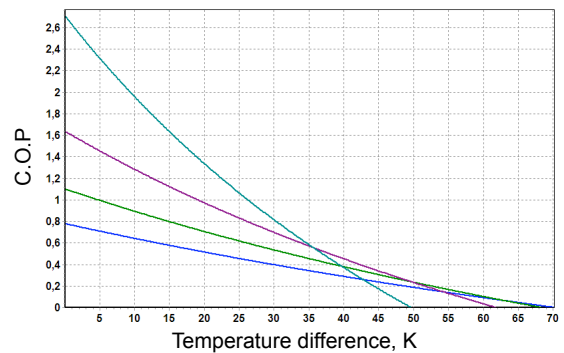
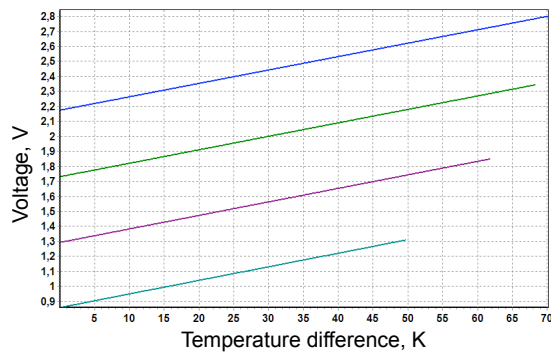
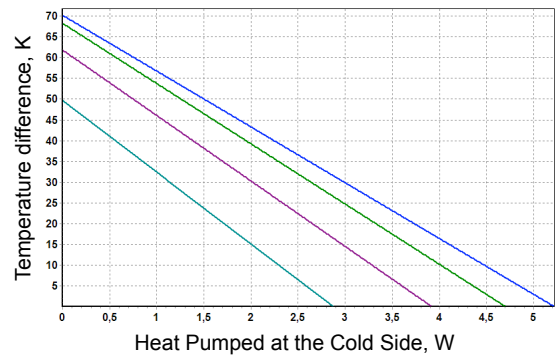
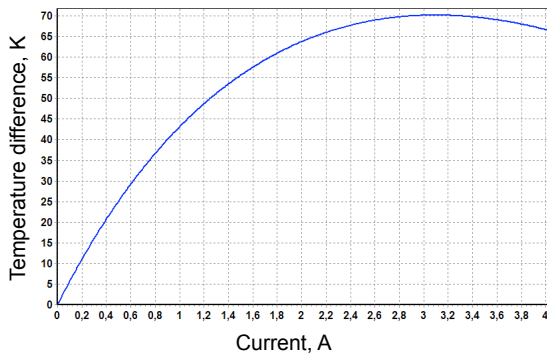

Performance Plots 1ML06-023-07t

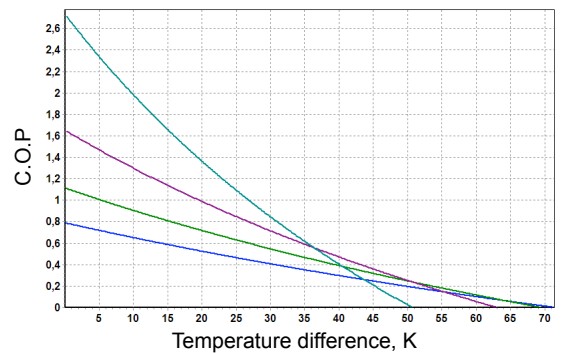
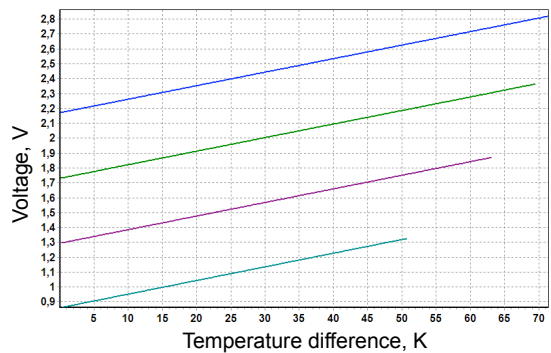
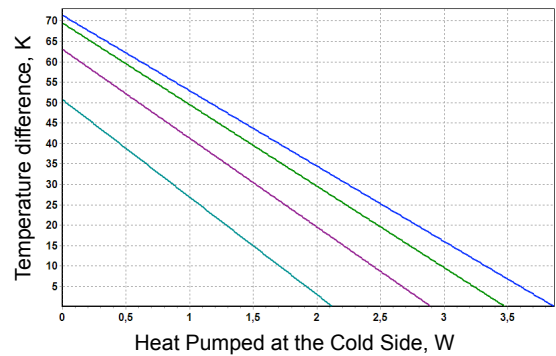
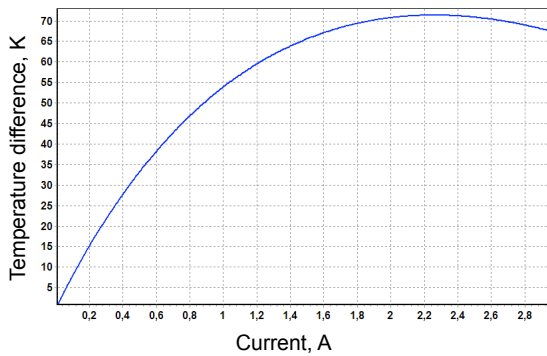

Color Legend: **Imax**, **0.8 Imax**, **0.6 Imax**, **0.4 Imax**

Performance Plots

1ML06-023-09t

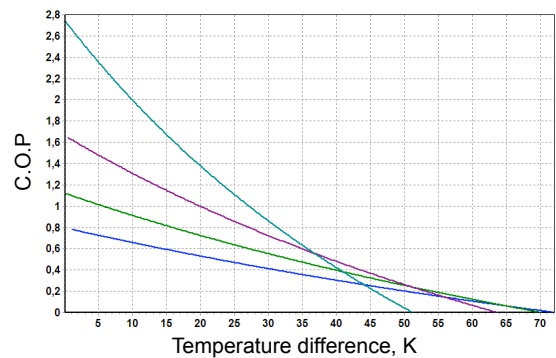
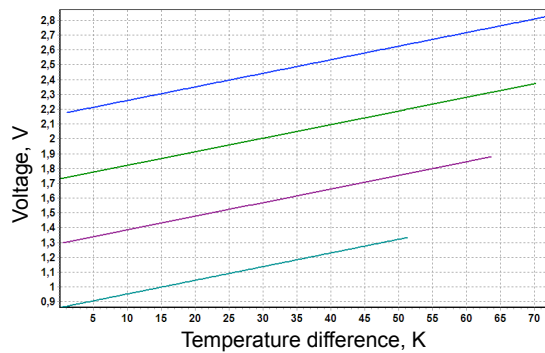
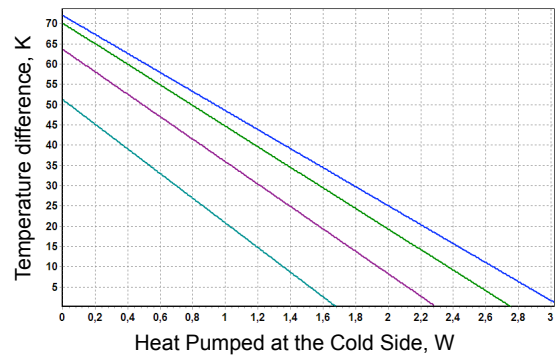
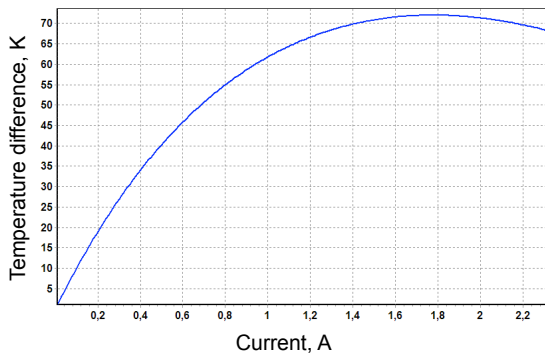

Performance Plots

1ML06-023-12t

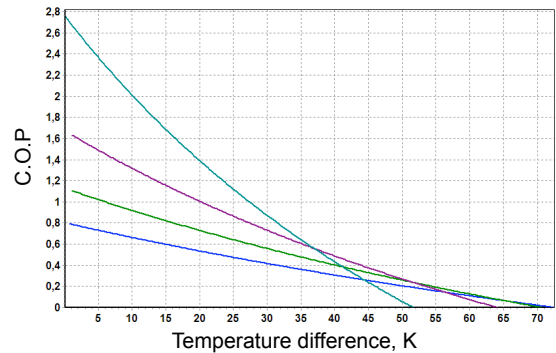
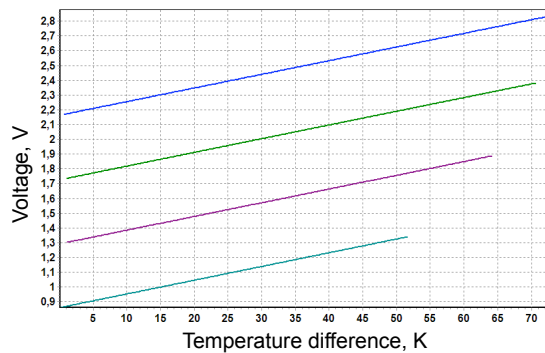
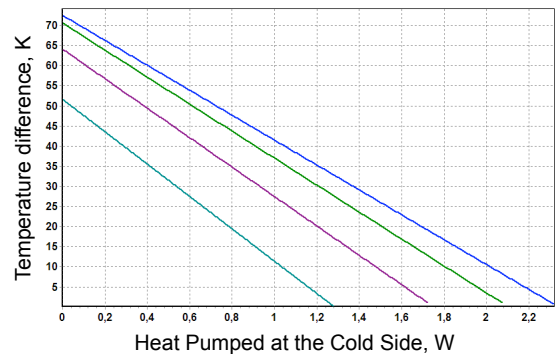
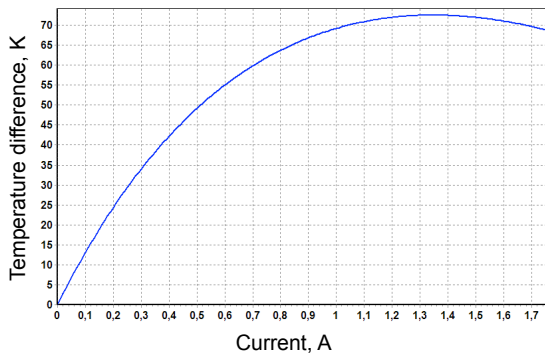

Color Legend: **I<sub>max</sub>**, **0.8 I<sub>max</sub>**, **0.6 I<sub>max</sub>**, **0.4 I<sub>max</sub>**

### Application Tips

1. Never heat TE module more than 200°C (TEC assembled at 230°C).
2. Never use TE module without attached heat sink at hot (bottom) side.
3. Connect TE module to DC power supply according to polarity.
4. Do not apply DC current higher than  $I_{max}$ .

### Installation

1. Mechanical Mounting. TEC is placed between two heat exchangers. This construction is fixed by screws or in another mechanical way. It is suitable for large modules (with dimensions 30x30mm and larger). Miniature types require other assembling methods in most cases.
2. Soldering. This method is suitable for a TE module with metallized outside surfaces. RMT provides this option and also makes pre-tinning for TE modules.
3. Glueing. It is an up-to-date method that is used by many customers due to availability of glues with good thermoconductive properties. A glue is usually based on some epoxy compound filled with some thermoconductive material such as graphite or diamond powders, silver, SiN and others. The application of a specific type depends on application features and the type of a TE module.

