

PLEASE CHECK WWW.MOLEX.COM FOR LATEST PART INFORMATION

Part Number: [0705430110](#)
Status: **Active**
Overview: [cgrid_sl_products](#)
Description: 2.54mm (.100") Pitch SL™ Header, Single Row, Vertical, .120" Pocket, Shrouded, 6 Circuits, 0.76µm (30µ") Gold (Au) Selective Plating, Tin (Sn) PC Tail Plating

Documents:

3D Model	Product Specification PS-70400 (PDF)
Packaging Specification (PDF)	Product Specification PS-70541 (PDF)
Drawing (PDF)	RoHS Certificate of Compliance (PDF)

Agency Certification

CSA	LR19980
UL	E29179

General

Product Family	PCB Headers
Series	70543
Application	Wire-to-Board
Overview	cgrid_sl_products
Product Name	SL™

Physical

Breakaway	No
Circuits (Loaded)	6
Color - Resin	Black
Durability (mating cycles max)	50
First Mate / Last Break	No
Flammability	94V-0
Glow-Wire Compliant	No
Guide to Mating Part	No
Keying to Mating Part	None
Lock to Mating Part	Yes
Material - Metal	Brass, Phosphor Bronze
Material - Plating Mating	Gold
Material - Plating Termination	Tin
Material - Resin	High Temperature Thermoplastic
Number of Rows	1
Orientation	Vertical
PC Tail Length (in)	0.130 In
PC Tail Length (mm)	3.30 mm
PCB Locator	No
PCB Retention	None
PCB Thickness Recommended (in)	0.062 In
PCB Thickness Recommended (mm)	1.60 mm
Packaging Type	Tube
Pitch - Mating Interface (in)	0.100 In
Pitch - Mating Interface (mm)	2.54 mm
Pitch - Term. Interface (in)	0.100 In
Pitch - Term. Interface (mm)	2.54 mm
Plating min: Mating (µin)	30
Plating min: Mating (µm)	0.75
Plating min: Termination (µin)	75
Plating min: Termination (µm)	1.875
Polarized to Mating Part	Yes
Shrouded	Fully

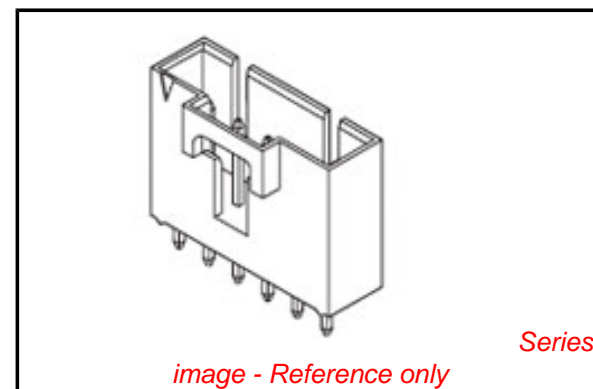

image - Reference only

EU RoHS

ELV and RoHS Compliant

REACH SVHC

Not Reviewed

Halogen-Free

Status

Not Halogen-Free

Need more information on product environmental compliance?

Email productcompliance@molex.com
 For a multiple part number RoHS Certificate of Compliance, [click here](#)

Please visit the [Contact Us](#) section for any non-product compliance questions.

China RoHS



Search Parts in this Series

[70543Series](#)

Stackable	No
Surface Mount Compatible (SMC)	No
Temperature Range - Operating	-40°C to +105°C
Termination Interface: Style	Through Hole

Electrical

Current - Maximum per Contact	3A
Voltage - Maximum	250V

Solder Process Data

Duration at Max. Process Temperature (seconds)	3
Lead-free Process Capability	Wave Capable (TH only)
Max. Cycles at Max. Process Temperature	1
Process Temperature max. C	260

Material Info

Reference - Drawing Numbers

Packaging Specification	PK-70873-0014
Product Specification	PS-70400, PS-70541
Sales Drawing	SDA-70543-****

This document was generated on 05/24/2010

PLEASE CHECK WWW.MOLEX.COM FOR LATEST PART INFORMATION

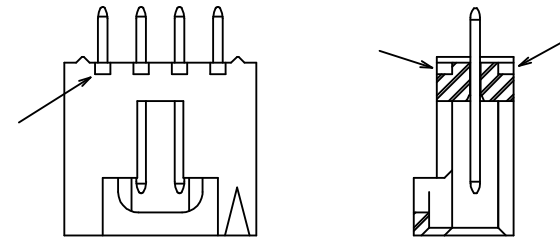
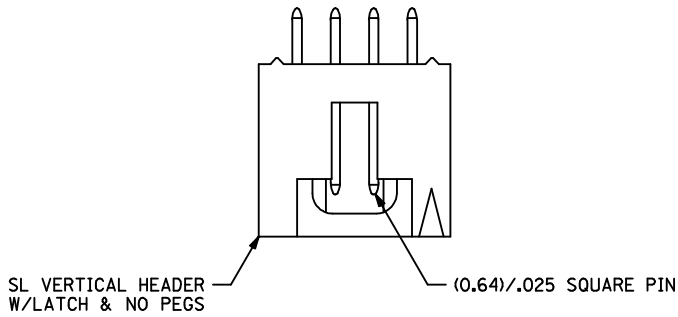

CKT. SIZE	DIM. "A"		DIM. "B"	
	MM	IN.	MM	IN.
2	2.54	.100	5.33	.210
3	5.08	.200	8.13	.320
4	7.62	.300	10.67	.420
5	10.16	.400	13.21	.520
6	12.70	.500	15.75	.620
7	15.24	.600	18.29	.720
8	17.78	.700	20.83	.820
9	20.32	.800	23.37	.920
10	22.86	.900	25.91	1.020
11	25.40	1.000	28.45	1.120
12	27.94	1.100	30.99	1.220
13	30.48	1.200	33.53	1.320
14	33.02	1.300	36.07	1.420
15	35.56	1.400	38.61	1.520
16	38.10	1.500	41.15	1.620
17	40.64	1.600	43.69	1.720
18	43.18	1.700	46.23	1.820
19	45.72	1.800	48.77	1.920
20	48.26	1.900	51.31	2.020
21	50.80	2.000	53.85	2.120
22	53.34	2.100	56.39	2.220
23	55.88	2.200	58.93	2.320
24	58.42	2.300	61.47	2.420
25	60.96	2.400	64.01	2.520

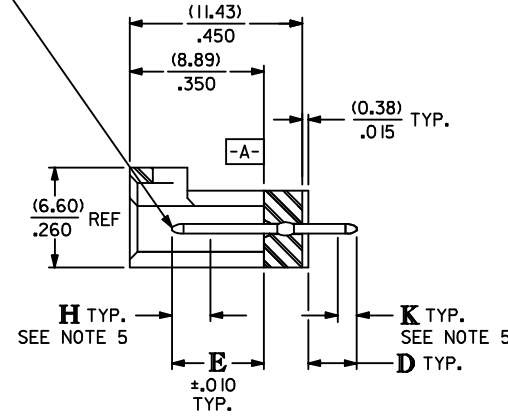
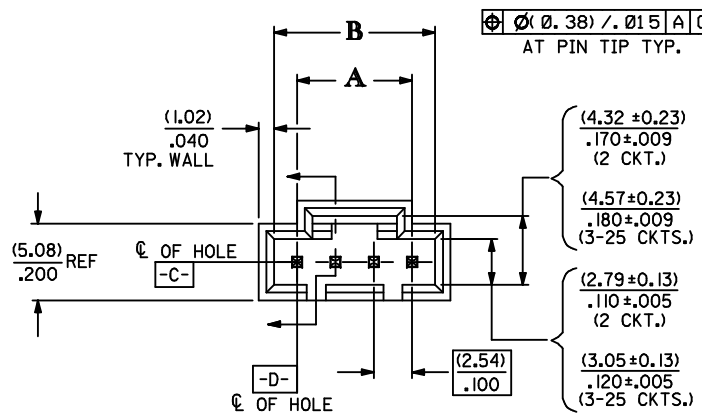

NOTES:

1. HEADER MATERIAL: GLASS FILLED POLYESTER;
UL94V-0; COLOR: BLACK
PIN MATERIAL: PHOSPHOR BRONZE
2. HEADER TO BE USED WITH OPTION 'G' 70400 AND 70430
SERIES SL CONNECTORS.
3. REFER TO MOLEX PRODUCT SPECIFICATION PS-70541.
4. STANDARD PACKAGING PER PK-70873-0014.
5. MEASURE POINT FOR PLATING THICKNESS.

PLATING:

- TIN - 3.81 MICROMETERS/150 MICROINCHES MINIMUM BRIGHT TIN PLATE
OVER 1.27 MICROMETERS/50 MICROINCHES MINIMUM NICKEL PLATE
- 15 GOLD - 0.38 MICROMETERS/15 MICROINCHES MINIMUM GOLD PLATE IN SELECT AREA
1.91 MICROMETERS/75 MICROINCHES MINIMUM MATTE TIN PLATE IN SELECT AREA
OVER 1.27 MICROMETERS/50 MICROINCHES MINIMUM NICKEL PLATE OVERALL
- 30 GOLD - 0.76 MICROMETERS/15 MICROINCHES MINIMUM GOLD PLATE IN SELECT AREA
1.91 MICROMETERS/75 MICROINCHES MINIMUM MATTE TIN PLATE IN SELECT AREA
OVER 1.27 MICROMETERS/50 MICROINCHES MINIMUM NICKEL PLATE OVERALL

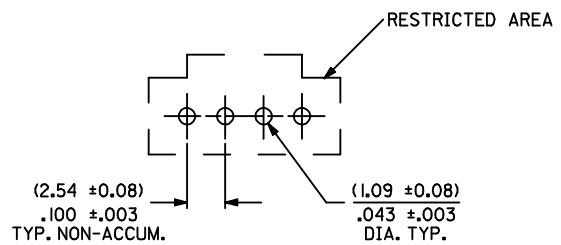

RECOMMENDED PC BOARD LAYOUT

(FOR USE WITH (1.57)/.062 THICK BOARD)

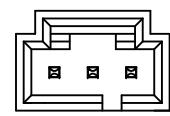
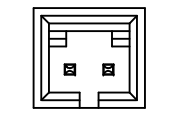

ADD PLATING FINISH EC NO: UCP2009-1566 2008/12/17 DRWIN:SBARRA 2008/12/17 CHKD:DMORGAN 2008/12/18 APPR:SMILLER	DESCRIPTION REV	QUALITY SYMBOLS ▽=0 ▽=0	GENERAL TOLERANCES (UNLESS SPECIFIED)		DIMENSION STYLE MM/IN	SCALE 4:1	DESIGN UNITS INCH	THIRD ANGLE PROJECTION	
			mm	INCH	DRAWN BY AAB	DATE 1987/09/22	CHECKED BY MJM	DATE 1987/09/22	APPROVED BY WAZ
DRAFT WHERE APPLICABLE MUST REMAIN WITHIN DIMENSIONS			SIZE C		MATERIAL NO. SEE TABLE		DOCUMENT NO. SDA-70543-****		
THIS DRAWING CONTAINS INFORMATION THAT IS PROPRIETARY TO MOLEX INCORPORATED AND SHOULD NOT BE USED WITHOUT WRITTEN PERMISSION								SHEET NO. 1 OF 2	

SALES ASSY, SL VERTICAL
HEADER W/LATCH & NO PEGS
(2.54)/.100 CENTERS

MOLEX INCORPORATED

CIRCUIT SIZE	ASSEMBLY ITEM NUMBER 70543	MANUFACTURE RELEASE STATUS	D REF.	E ± .010	CONNECTOR END PLATING			P.C. BOARD END PLATING		
					TYPE	H MEAS.		TYPE	FINISH	K MEAS.
2-25	-0001-0024	R.F.M.	(3.30) .130	(6.10) .240	15 GOLD	(2.54) .100		TIN	MATTE	(1.27) .050
2-25	-0036-0059	R.F.M.	(3.30) .130	(6.10) .240	TIN	(2.54) .100		TIN	BRIGHT	(1.27) .050
2-25	-0071-0094	R.F.M.	(3.81) .150	(6.10) .240	TIN	(2.54) .100		TIN	BRIGHT	(1.27) .050
2-25	-0106-0129	R.F.M.	(3.30) .130	(6.10) .240	30 GOLD	(2.54) .100		TIN	MATTE	(1.27) .050
2-25	-0141-0164	R.F.M.	(2.54) .100	(6.10) .240	15 GOLD	(3.94) .155		TIN	MATTE	(1.27) .050
2-25	-0165-0188	R.F.M.	(3.81) .150	(6.10) .240	30 GOLD	(2.54) .100		TIN	MATTE	(1.27) .050
2-25	-0200-0223	R.F.M.	(3.81) .150	(6.10) .240	15 GOLD	(2.54) .100		TIN	MATTE	(1.27) .050
2-25	-0248-0271	R.F.M.	(4.06) .160	(6.10) .240	TIN	(2.54) .100		TIN	BRIGHT	(1.27) .050
2-25	-0272-0295	R.F.M.	(4.06) .160	(6.10) .240	15 GOLD	(2.54) .100		TIN	MATTE	(1.27) .050
2-25	-0296-0319	R.F.M.	(4.06) .160	(6.10) .240	30 GOLD	(2.54) .100		TIN	MATTE	(1.27) .050

CIRCUIT SIZE	ASSEMBLY ITEM NUMBER	ASSEMBLY ITEM NUMBER	ASSEMBLY ITEM NUMBER	ASSEMBLY ITEM NUMBER	ASSEMBLY ITEM NUMBER	ASSEMBLY ITEM NUMBER	ASSEMBLY ITEM NUMBER	ASSEMBLY ITEM NUMBER	ASSEMBLY ITEM NUMBER	ASSEMBLY ITEM NUMBER	ASSEMBLY ITEM NUMBER	CIRCUIT SIZE
2	70543-0001	70543-0036	70543-0071	70543-0106	70543-0141	70543-0165	70543-0200	70543-0248	70543-0272	70543-0296	2	
3	70543-0002	70543-0037	70543-0072	70543-0107	70543-0142	70543-0166	70543-0201	70543-0249	70543-0273	70543-0297	3	
4	70543-0003	70543-0038	70543-0073	70543-0108	70543-0143	70543-0167	70543-0202	70543-0250	70543-0274	70543-0298	4	
5	70543-0004	70543-0039	70543-0074	70543-0109	70543-0144	70543-0168	70543-0203	70543-0251	70543-0275	70543-0299	5	
6	70543-0005	70543-0040	70543-0075	70543-0110	70543-0145	70543-0169	70543-0204	70543-0252	70543-0276	70543-0300	6	
7	70543-0006	70543-0041	70543-0076	70543-0111	70543-0146	70543-0170	70543-0205	70543-0253	70543-0277	70543-0301	7	
8	70543-0007	70543-0042	70543-0077	70543-0112	70543-0147	70543-0171	70543-0206	70543-0254	70543-0278	70543-0302	8	
9	70543-0008	70543-0043	70543-0078	70543-0113	70543-0148	70543-0172	70543-0207	70543-0255	70543-0279	70543-0303	9	
10	70543-0009	70543-0044	70543-0079	70543-0114	70543-0149	70543-0173	70543-0208	70543-0256	70543-0280	70543-0304	10	
11	70543-0010	70543-0045	70543-0080	70543-0115	70543-0150	70543-0174	70543-0209	70543-0257	70543-0281	70543-0305	11	
12	70543-0011	70543-0046	70543-0081	70543-0116	70543-0151	70543-0175	70543-0210	70543-0258	70543-0282	70543-0306	12	
13	70543-0012	70543-0047	70543-0082	70543-0117	70543-0152	70543-0176	70543-0211	70543-0259	70543-0283	70543-0307	13	
14	70543-0013	70543-0048	70543-0083	70543-0118	70543-0153	70543-0177	70543-0212	70543-0260	70543-0284	70543-0308	14	
15	70543-0014	70543-0049	70543-0084	70543-0119	70543-0154	70543-0178	70543-0213	70543-0261	70543-0285	70543-0309	15	
16	70543-0015	70543-0050	70543-0085	70543-0120	70543-0155	70543-0179	70543-0214	70543-0262	70543-0286	70543-0310	16	
17	70543-0016	70543-0051	70543-0086	70543-0121	70543-0156	70543-0180	70543-0215	70543-0263	70543-0287	70543-0311	17	
18	70543-0017	70543-0052	70543-0087	70543-0122	70543-0157	70543-0181	70543-0216	70543-0264	70543-0288	70543-0312	18	
19	70543-0018	70543-0053	70543-0088	70543-0123	70543-0158	70543-0182	70543-0217	70543-0265	70543-0289	70543-0313	19	
20	70543-0019	70543-0054	70543-0089	70543-0124	70543-0159	70543-0183	70543-0218	70543-0266	70543-0290	70543-0314	20	
21	70543-0020	70543-0055	70543-0090	70543-0125	70543-0160	70543-0184	70543-0219	70543-0267	70543-0291	70543-0315	21	
22	70543-0021	70543-0056	70543-0091	70543-0126	70543-0161	70543-0185	70543-0220	70543-0268	70543-0292	70543-0316	22	
23	70543-0022	70543-0057	70543-0092	70543-0127	70543-0162	70543-0186	70543-0221	70543-0269	70543-0293	70543-0317	23	
24	70543-0023	70543-0058	70543-0093	70543-0128	70543-0163	70543-0187	70543-0222	70543-0270	70543-0294	70543-0318	24	
25	70543-0024	70543-0059	70543-0094	70543-0129	70543-0164	70543-0188	70543-0223	70543-0271	70543-0295	70543-0319	25	

X IN COLUMN UNDER *ASSEMBLY ITEM NUMBER* HEADING DENOTES TOOLING NOT AVAILABLE

ADD PLATING FINISH	QUALITY SYMBOLS
EC NO: UCP2009-1566 2008/12/17 DRWINMS BARRA 2008/12/17 CHKD: MORGAN 2008/12/17 APPR: MILLER 2008/12/18	<p>▽=0</p> <p>▽=0</p>
REV	DESCRIPTION

GENERAL TOLERANCES (UNLESS SPECIFIED)	
mm	INCH
4 PLACES ± ---	± ---
3 PLACES ± ---	± .005
2 PLACES ± 0.13	± .010
1 PLACE ± 0.25	± ---
ANGULAR ± 1/2°	
DRAFT WHERE APPLICABLE MUST REMAIN WITHIN DIMENSIONS	

DIMENSION STYLE	
MM/IN	
DRAWN BY	DATE
AAB	1987/09/22
CHECKED BY	DATE
MJM	1987/09/22
APPROVED BY	DATE
WAZ	1987/09/22
MATERIAL NO.	DOCUMENT NO.
SEE TABLE	SDA-70543-***

SCALE 4:1	DESIGN UNITS INCH	THIRD ANGLE PROJECTION
SALES ASSY, SL VERTICAL HEADER W/LATCH & NO PEGS (2.54)/.100 CENTERS		
MOLEX MOLEX INCORPORATED		
SHEET NO. 2 OF 2		
THIS DRAWING CONTAINS INFORMATION THAT IS PROPRIETARY TO MOLEX INCORPORATED AND SHOULD NOT BE USED WITHOUT WRITTEN PERMISSION		