

DD Dolby B* type Noise Reduction System

Description

The CXA1550/CXA1551/CXA1552/CXA1553 are bipolar ICs providing two separate Dolby B type noise reduction processors. The series is composed of seven devices having four Dolby levels and two types of package for various applications. These devices feature very few external components, which is achieved by monolithic filter circuits using integrated thin film capacitors with high capacitance.

Features

- Pin replaceable with CXA1100 series
- Minimum number of external components
- NR ON/OFF/Double Speed, REC/PB switches included
- Small package (16 pin SOP, 16 pin DIP)
- Low current consumption 5.6mA typ.
- Dual channel processors in one chip
- Double speed encode and decode functions are provided.

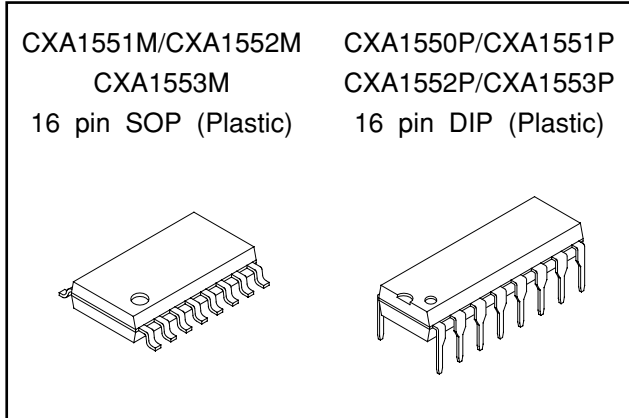

Absolute Maximum Ratings (Ta=25 °C)

- Supply voltage V_{CC} 23 V
- Operating temperature T_{opr} -40 to +85 °C
- Storage temperature T_{stg} -65 to +150 °C
- Allowable power dissipation P_D

SOP16 (A1551M/A1552M/A1553M)	500 mW
DIP16 (A1550P/A1551P/A1552P/A1553P)	900 mW

* These ICs are available only to the licensees of Dolby Laboratories Licensing Corporation from whom licensing and applications information may be obtained.

* "Dolby" and the double D symbols are trade marks of Dolby Laboratories Licensing Corporation.

Sony reserves the right to change products and specifications without prior notice. This information does not convey any license by any implication or otherwise under any patents or other right. Application circuits shown, if any, are typical examples illustrating the operation of the devices. Sony cannot assume responsibility for any problems arising out of the use of these circuits.

Block Diagram

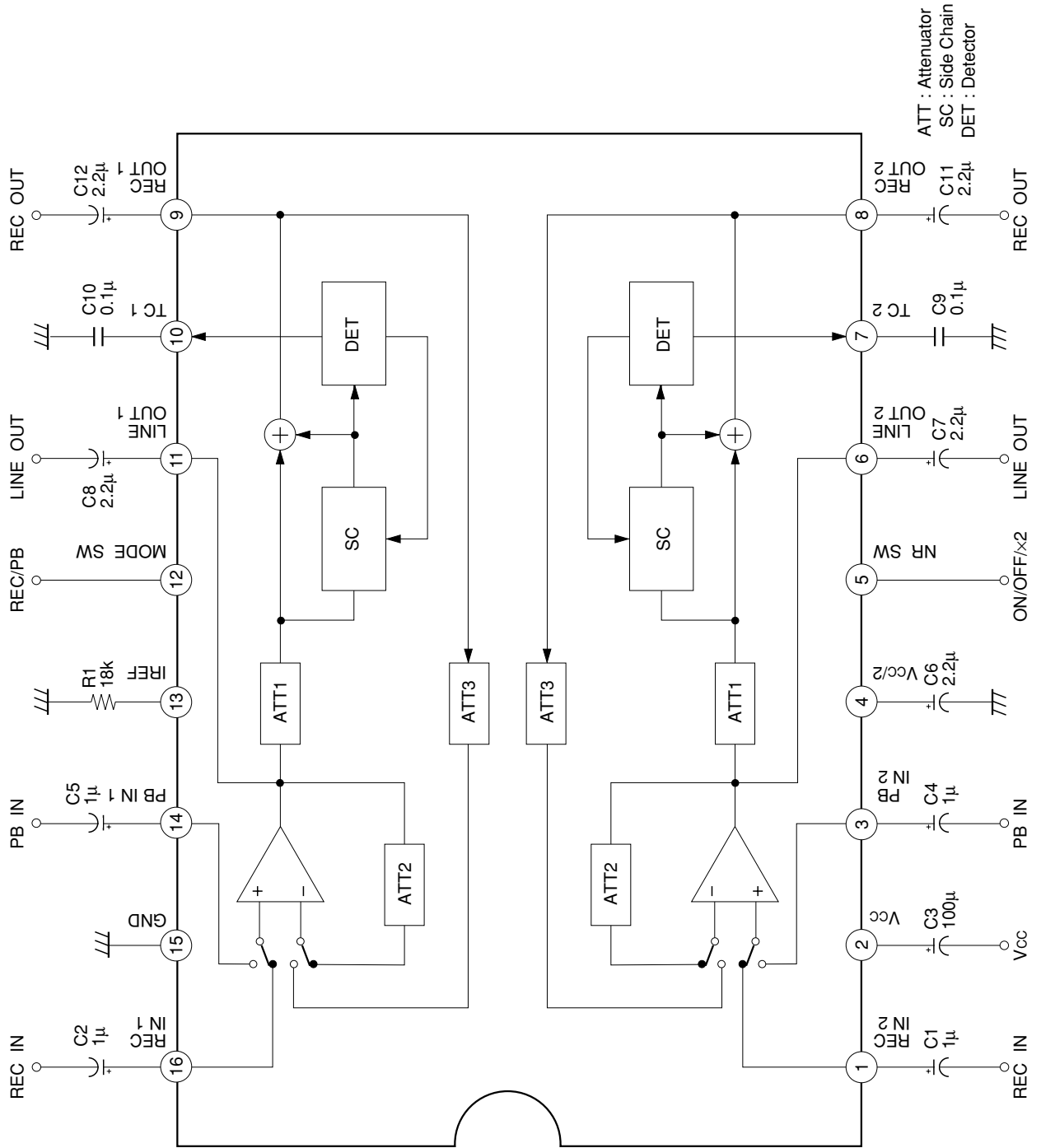

Pin Description and Equivalent Circuit

(Ta=25 °C, Vcc=12 V, single supply, no signal)

Pin No.	Symbol	Z (in)	VDC (V)	Equivalent circuit	Description
1, 16	REC IN	40 k	6.0 V		Recording (encode) input pin
2	Vcc	—	12.0 V		Vcc power supply pin
3, 14	PB IN	40 k	6.0 V		Playback (decode) input pin
4	VCT	2 k	6.0 V		Vcc/2 output pin
5	NRSW	—	—		NR control pin H : Double speed M : NR off L : NR on
6, 11	LINE OUT	—	6.0 V		Line (decode) output pin

Pin No.	Symbol	Z (in)	VDC (V)	Equivalent circuit	Description
7, 10	TC	—	0.3 V		Time constant connecting pin
8, 9	REC OUT	—	6.0 V		Recording (encode) output pin
12	MODE	—	—		REC/PB (encode/decode) control pin H : PB L : REC
13	IREF	—	1.2 V		Active filter reference current input pin
15	GND	—	0 V		GND pin

Electrical Characteristics

Ta=25 °C, Dolby Level: -10 dBm (=245 mVrms) at RECOU, 0 dBm=775 mVrms, Vcc=15 V (CXA1550), Vcc=12 V (CXA1551), Vcc=9 V (CXA1552), Vcc=6 V (CXA1553) unless otherwise specified

Characteristics		Symbol	Test Conditions				Min.	Typ.	Max.	Unit	
			R/P	NR	f (Hz)	other					
Operating voltage	CXA1550	Vopr	—	—	—	Signal handling ≥12 dB	11.5	—	16.0	V	
	CXA1551						8.5	—	16.0	V	
	CXA1552						6.5	—	16.0	V	
	CXA1553						5.0	—	16.0	V	
Current consumption	CXA1550	Icc	REC	OFF	—	No signal	3.5	5.6	7.7	mA	
	CXA1551						3.5	5.5	7.7	mA	
	CXA1552						3.5	5.3	7.7	mA	
	CXA1553						3.5	5.1	7.7	mA	
LINE OUT level	CXA1550	Vlout	REC	OFF	1 k		-1.0	0.0	1.0	dBm	
	CXA1551						-4.0	-3.0	-2.0	dBm	
	CXA1552						-7.0	-6.0	-5.0	dBm	
	CXA1553						-11.0	-10.0	-9.0	dBm	
REC IN Level		Vrin	REC	OFF	1 k		-32	-30	-28	dBm	
PB IN Level		Vpin	REC	OFF	1 k		-32	-30	-28	dBm	
Encode characteristics (Boost)	(1)	B-R-1	REC	ON	500	-25 dB	1.4	2.9	4.4	dB	
	(2)	B-R-2	REC	ON	2 k	-25 dB	5.5	7.0	8.5	dB	
	(3)	B-R-3	REC	ON	5 k	-25 dB	3.9	5.4	6.9	dB	
	(4)	B-R-4	REC	ON	10 k	-40 dB	9.7	10.4	11.9	dB	
	(5)	B-R-5	REC	ON	10 k	0 dB	-1.1	0.4	1.9	dB	
Signal handling	CXA1550	Vomax	REC	OFF	1 k	THD=1 %	13.5	15.3	—	dB	
	CXA1551						14.0	15.9	—	dB	
	CXA1552						14.0	15.9	—	dB	
	CXA1553						13.0	15.0	—	dB	
Total harmonic distortion	(1) NR OFF	CXA1550	THD (OFF)	OFF			—	0.03	0.2	%	
		CXA1551					—	0.04	0.2	%	
	(2) NR ON	CXA1550	THD (ON)	ON				—	0.03	0.3	%
		CXA1551						—	0.04	0.3	%
		CXA1552						—	0.06	0.3	%
		CXA1553						—	0.09	0.3	%
Encode S/N ratio		SN (CCIR)	R	ON	—	Rg=5 kΩ (CCIR/ARM)	65	69	—	dB	
Crosstalk	REC-PB	CT-1					—	-82	-65	dB	
	PB-REC	CT-2					—	-81	-60	dB	
	REC ch to ch	CT-3					—	-70	-60	dB	
	PB ch to ch	CT-4					—	-70	-60	dB	
REC OUT offset voltage (NR ON-OFF)		Voff					-40	—	40	mV	
Control voltage	REC	VC-R					0	—	0.5	V	
	PB	VC-P					2.5	—	Vcc	V	
	ON	VC-ON					0	—	0.5	V	
	OFF	VC-OFF					2.5	—	Vcc-2.5	V	
	×2	VC-×2					Vcc-05	—	Vcc	V	

* 0 dB means the level which provides the Dolby level at the recording output in the noise reduction off mode.

Test Circuit

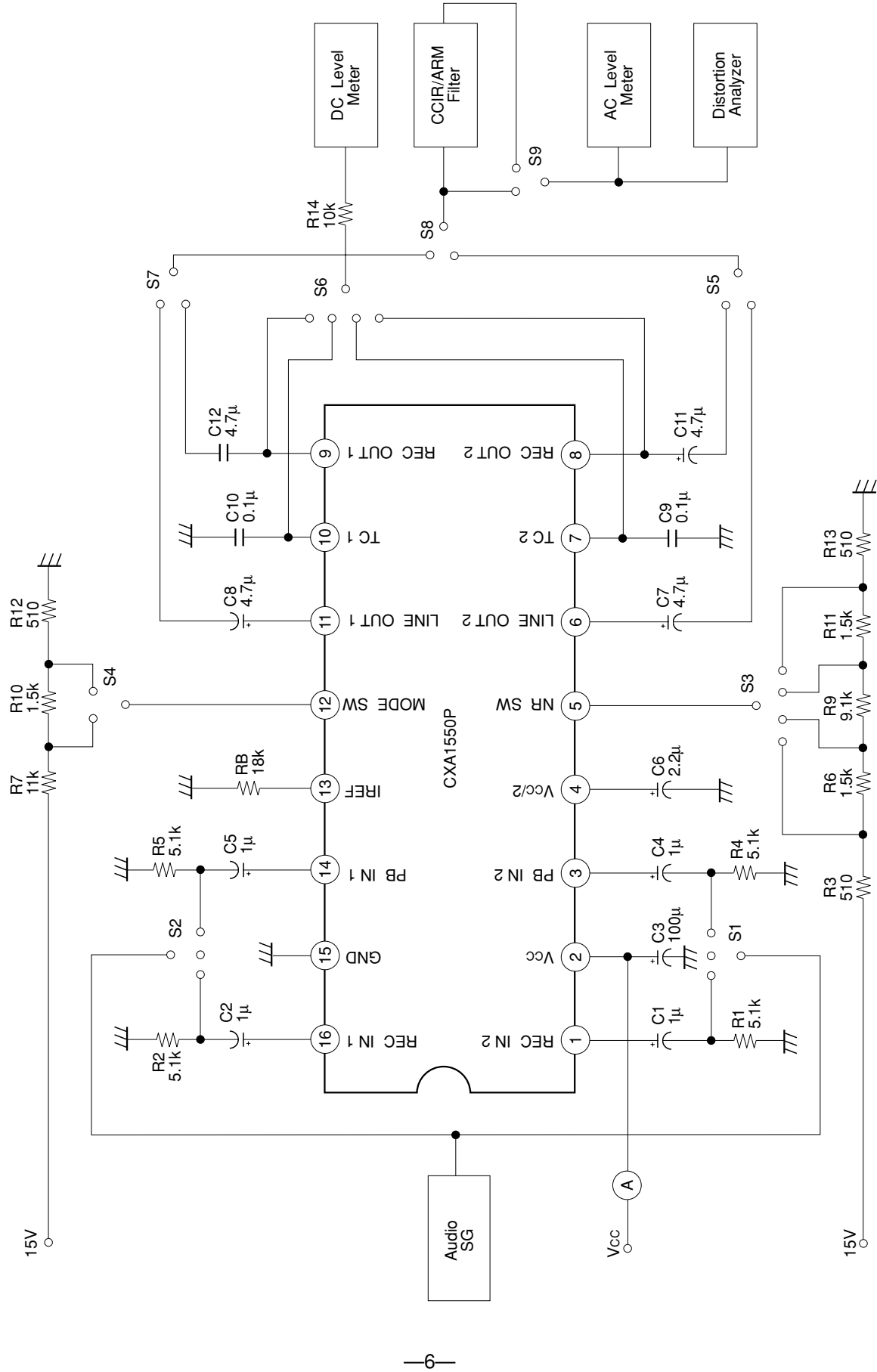

Playback Processor with AUX input

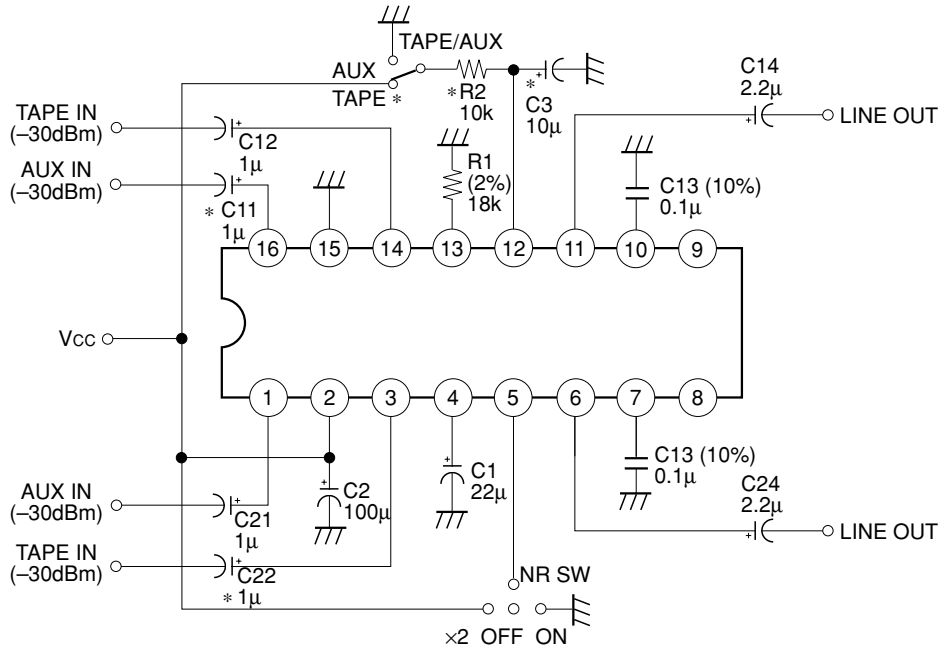

- Note)**
1. Resistor and capacitor tolerances are $\pm 10\%$ and $\pm 20\%$ respectively unless otherwise specified.
 2. When the AUX input is unnecessary, remove R₂, C₃, C₁₁, C₂₁ and TAPE/AUX control switch and connect Pin 12 to V_{cc}.

Application circuits shown are typical examples illustrating the operation of the devices. Sony cannot assume responsibility for any problems arising out of the use of these circuits or for any infringement of third party patent and other right due to same.

Notes on Applications

1) Power supply

The CXA1550 series is designed to operate on either single or split power supply. The ripple rejection performance is excellent for either supply. VCT (Pin 4) is a reference voltage of the $V_{CC}/2$ buffer amplifier. With single power supply operation, internally generated $V_{CC}/2$ voltage appears at the pin, and a bypass capacitor has to be connected between the pin and ground. On split power supply operation, the VCT (Pin 4) pin has to be connected to ground, and V_{EE} (negative power supply) is supplied to the GND (Pin 15) pin.

2) Double speed ($\times 2$)

The CXA1550 series provides double speed encode/decode modes, which offer high speed dubbing function. On double speed mode, the frequency response shifts twice as the normal B type.

3) Operational mode control

The CXA1550 series provides fully electronic switching circuits. The functions are controlled by DC voltage of the two control pins of REC/PB (Pin 12) and ON/OFF/ $\times 2$ (Pin 5). The switching truth tables are shown in Table 1.

Pin	Function	Single Supply	Split Supply
Pin 12	PB (Decode)	$V_{CC} \geq V \geq 2.5 \text{ V}$	$V_{CC} \geq V \geq V_{EE}+2.5 \text{ V}$
	REC (Encode)	$0.5 \text{ V} \geq V \geq 0 \text{ V}$	$V_{EE}+0.5 \text{ V} \geq V \geq V_{EE}$
Pin 5	NR $\times 2$	$V_{CC} \geq V \geq V_{CC}-0.5 \text{ V}$	$V_{CC} \geq V \geq V_{CC}-0.5 \text{ V}$
	NR OFF	$V_{CC}-2.5 \text{ V} \geq V \geq 2.5 \text{ V}$	$V_{CC}-2.5 \text{ V} \geq V \geq V_{EE}+2.5 \text{ V}$
	NR ON	$0.5 \text{ V} \geq V \geq 0 \text{ V}$	$V_{EE}+0.5 \text{ V} \geq V \geq V_{EE}$

Table 1.

It is desirable to provide CR time constant circuits at the mode control pins with time constant from 100 msec to 1 sec, which will reduce switching clicks effectively.

4) Reference levels

Characteristics and specifications of the Dolby noise reduction processor are defined as the levels and measured with reference to the Dolby level. This particular level in these devices is -10 dBm (245 mVrms), and is measured at the recording output (REC OUT) in the NR off mode.

The reference levels of the recording input (REC IN), playback input (PB IN) and line output (LINE OUT) are defined as the levels which provide the Dolby level at the recording output in the NR off mode.

The CXA1550 series has a common silicon die, and has different internal connection (AL pattern). The series provides four different line output levels for various applications. Other reference levels, recording input level, playback input level and recording output level (=Dolby level) are identical in all devices.

The reference levels are as follows

Recording output level (=Dolby level)		-10 dBm	(245 mVrms)
Recording input level		-30 dBm	(24.5 mVrms)
Playback input level		-30 dBm	(24.5 mVrms)
Line output level	CXA1550	0 dBm	(775 mVrms)
	CXA1551	-3 dBm	(548 mVrms)
	CXA1552	-6 dBm	(388 mVrms)
	CXA1553	-10 dBm	(245 mVrms)

5) MPX filter termination and C₁ for V_{CC}/2 (Pin 4)

The MPX (multiplex) filter termination method shown in Fig. 1 allows saving the coupling capacitors between the buffer amplifiers and MPX filters. However, the channel to channel separation and REC to PB crosstalk of low frequency signals will be degraded by the termination resistor R_T. For example, 5 kΩ of R_T will degrade the channel to channel separation to 50 dB. Better separation can be obtained by increasing the capacitance of C₁ (Pin 4) to 220 μF or 470 μF.

The allowable minimum value of C₁ is 47 μF, and 100 μF is the standard recommended value. Larger values of C₁ are generally desirable in order to improve the crosstalk and ripple rejection ratio.

6) Application for dubbing cassette decks

The CXA1550 series generates non decoded signal at the recoding output in the playback (decode) mode, and can simplify the structure of dubbing decks. See the Sony' Dolby B/C type IC (CX20187/CXA1097Q or CX20188/CXA1098Q) data sheet in detail.

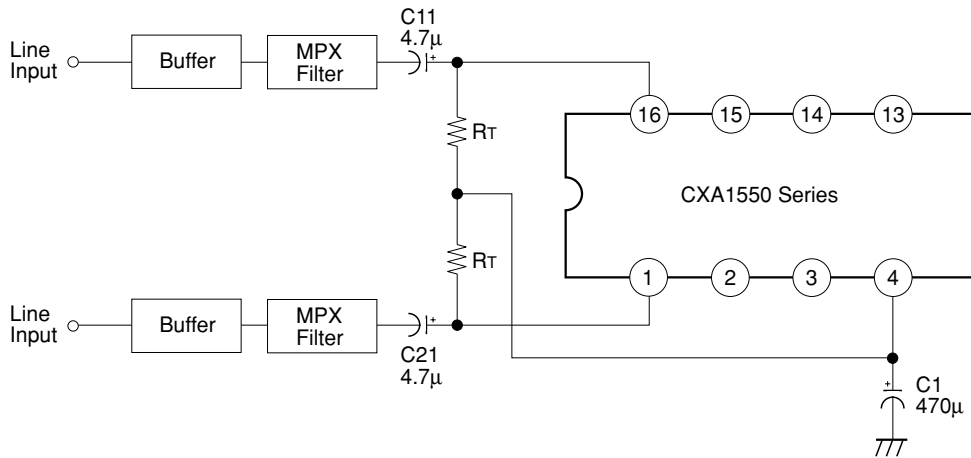
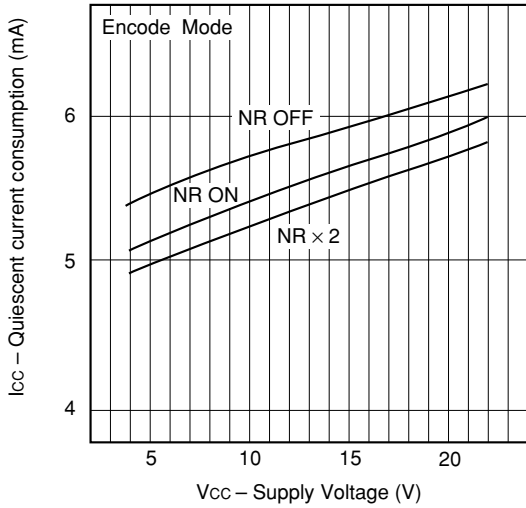

Fig. 1

Example of Representative Characteristics

Quiescent current consumption vs. Supply voltage



Current consumption vs. Input level (CXA1552)

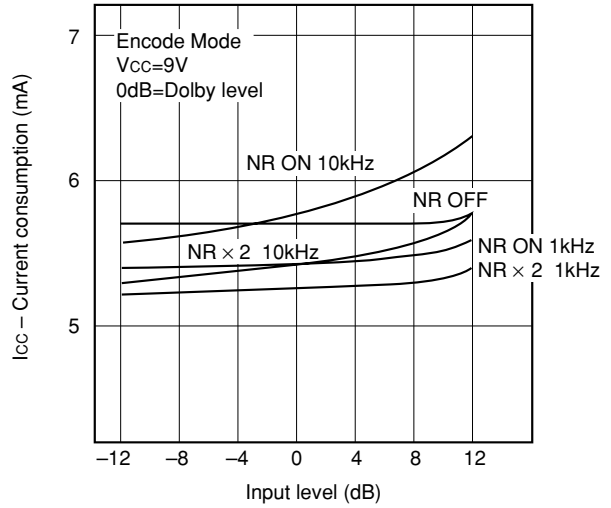

NR ON encode characteristics

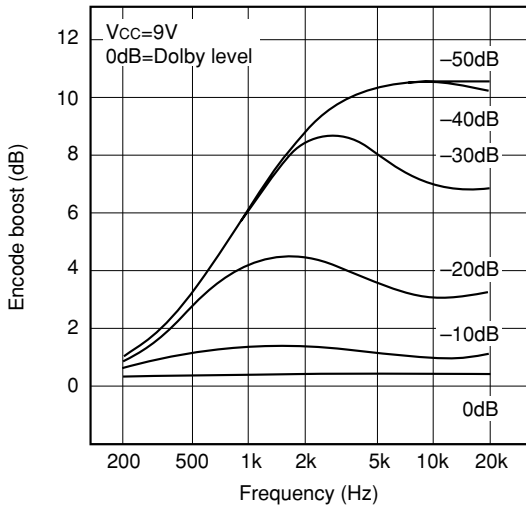

Double speed encode boost

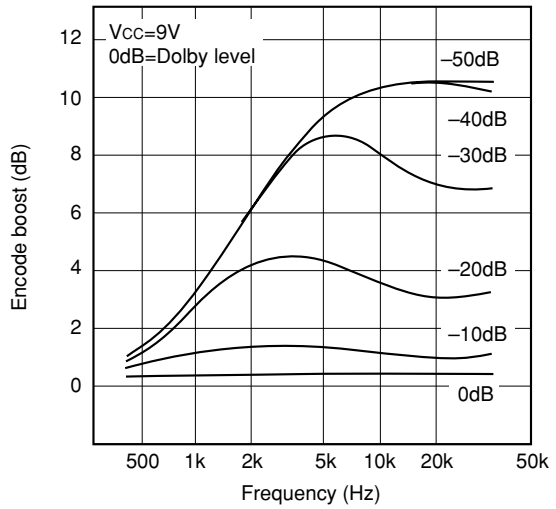

Signal handling

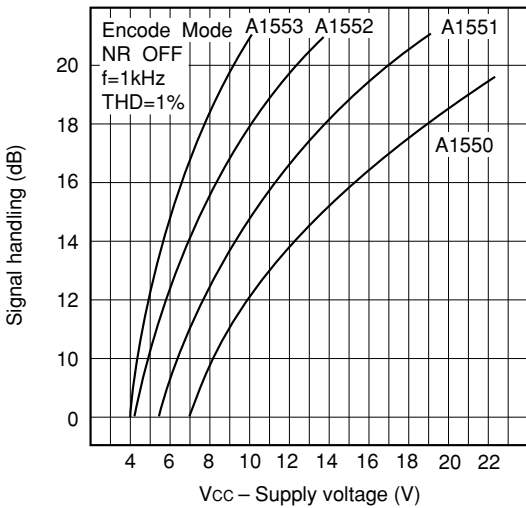

Load characteristics (CXA1552)

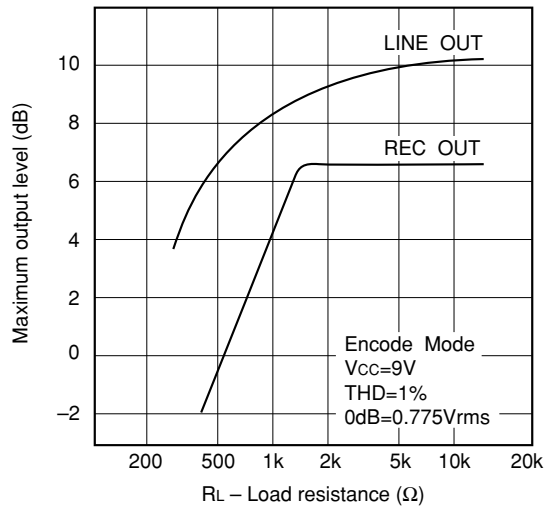

NR OFF total harmonic distortion -1 (CXA1551)

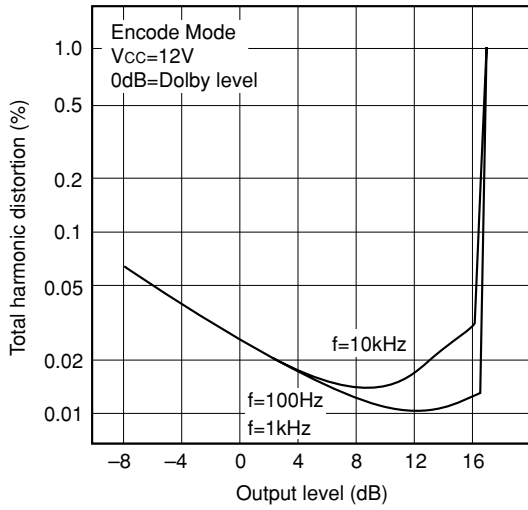

NR ON total harmonic distortion -1 (CXA1551)

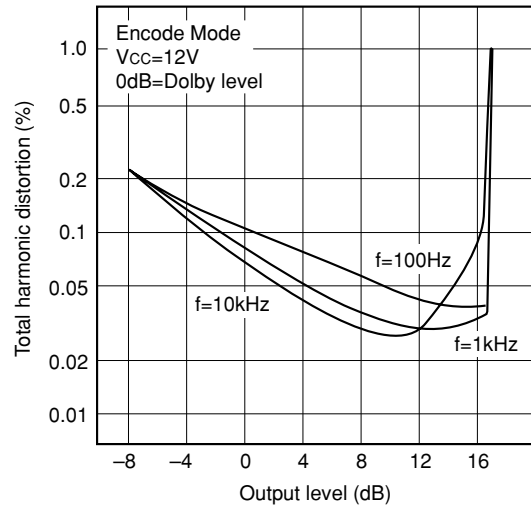

Double speed total harmonic distortion -1 (CXA1551)

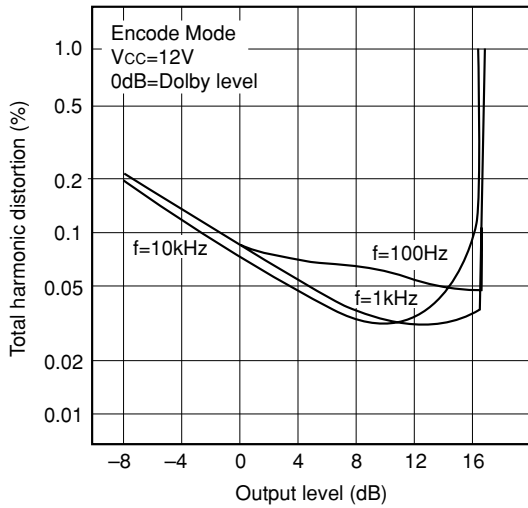

NR OFF total harmonic distortion -2 (CXA1550)

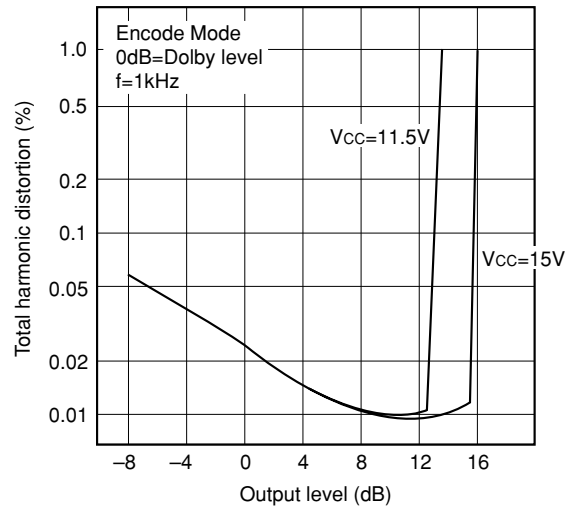

NR ON total harmonic distortion -2 (CXA1550)

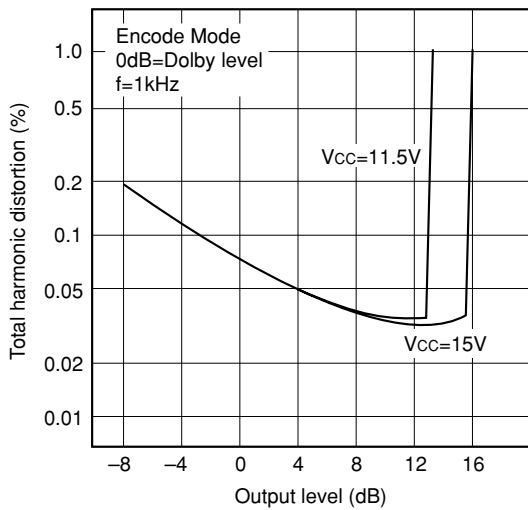

Double speed total harmonic distortion -2 (CXA1550)

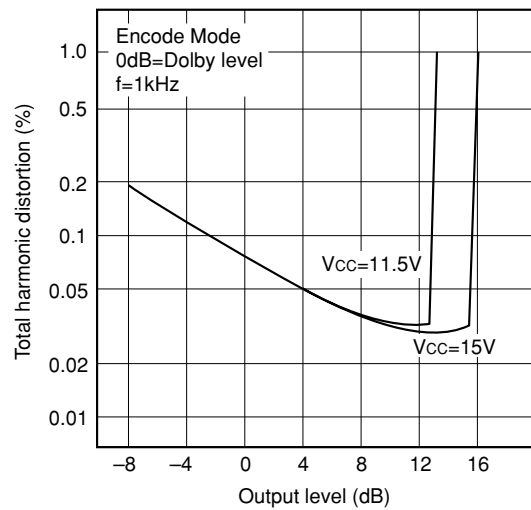

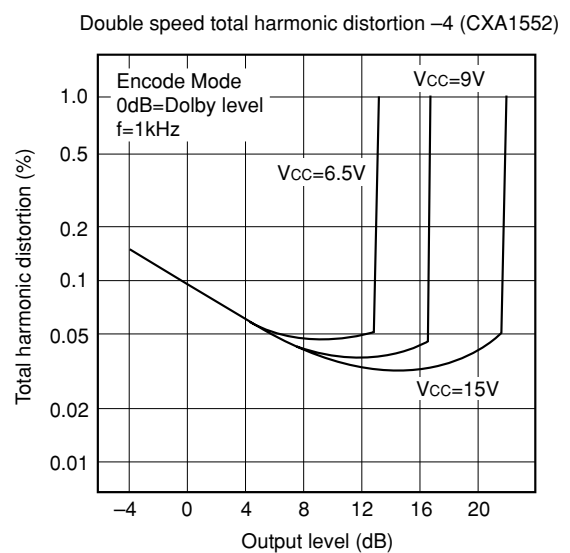
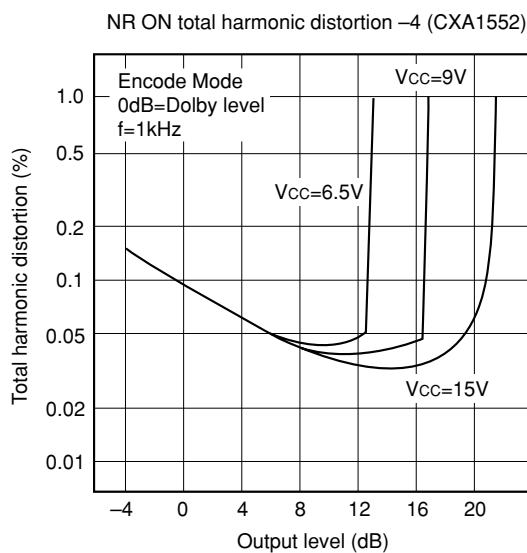
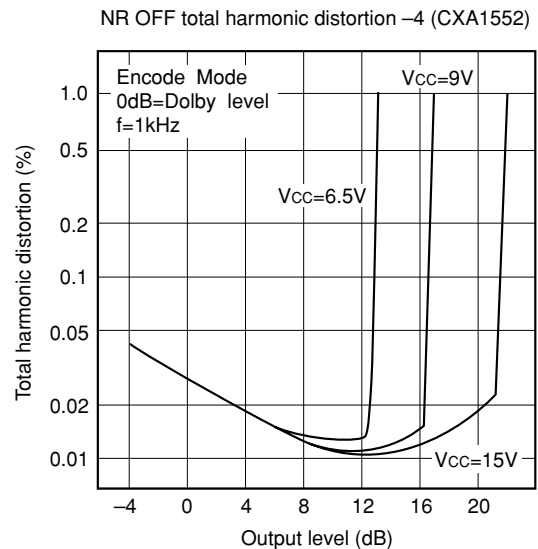
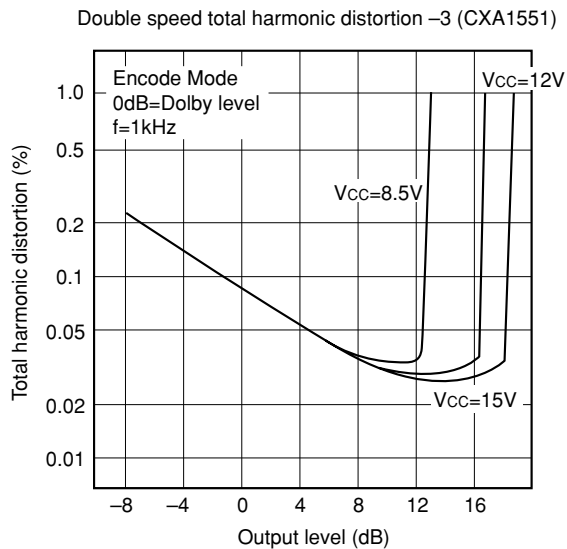
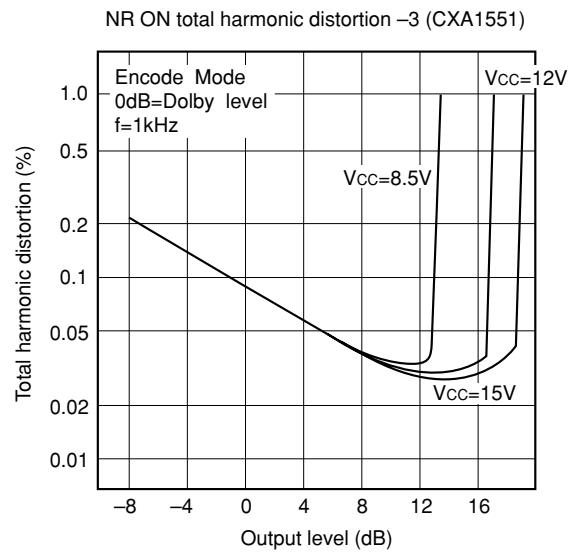
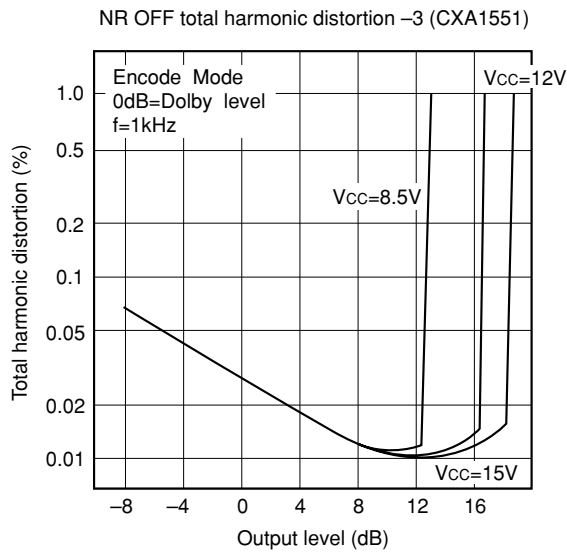

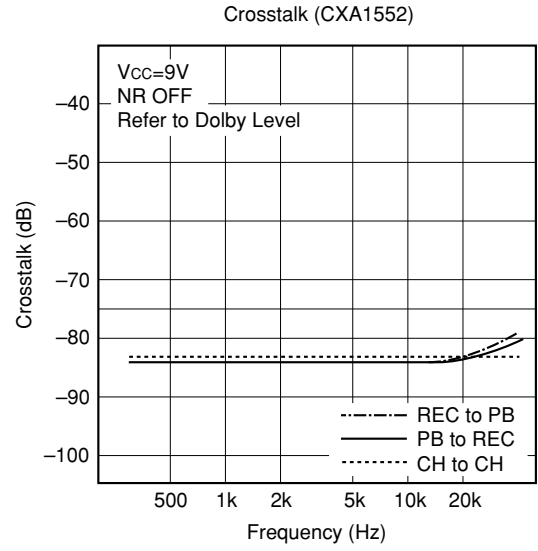
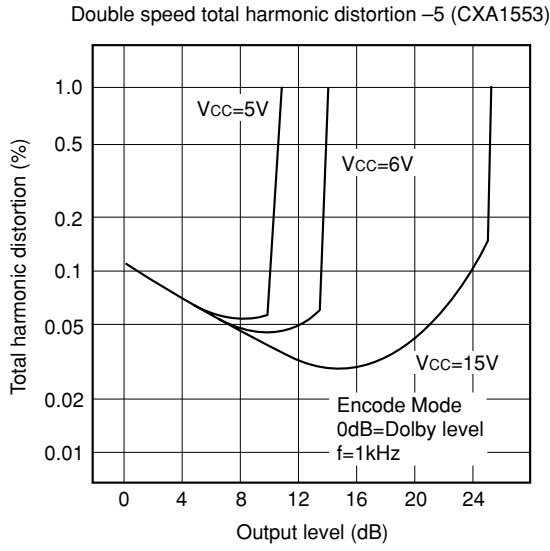
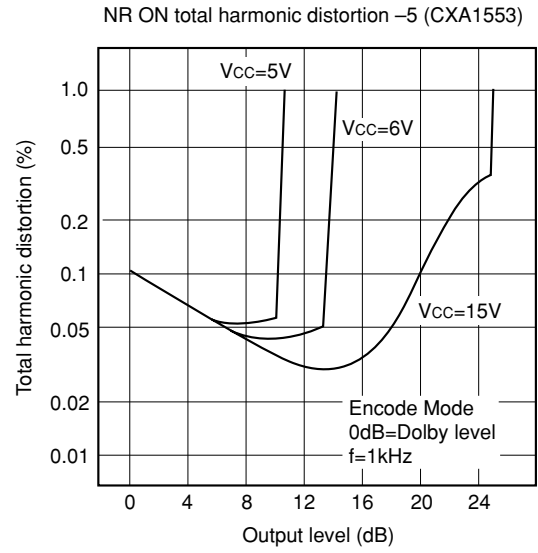
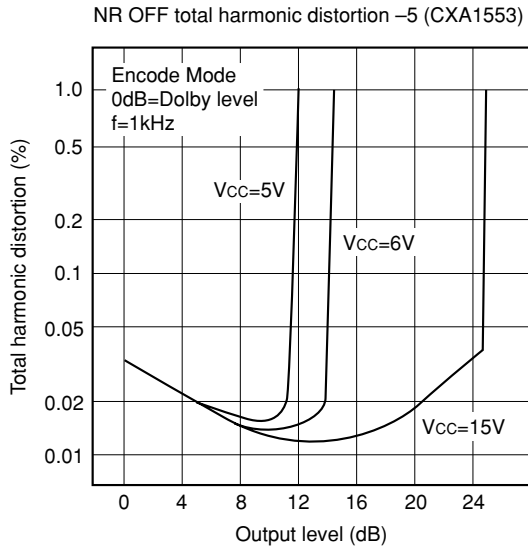

Package Outline Unit : mm

CXA1551M, CXA1552M
CXA1553M

16PIN SOP (PLASTIC)

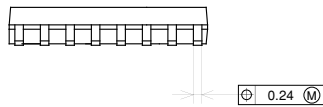
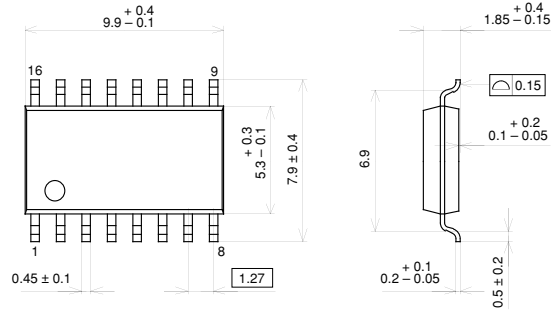

PACKAGE STRUCTURE

SONY CODE	SOP-16P-L01
EIAJ CODE	SOP016-P-0300
JEDEC CODE	

PACKAGE MATERIAL	EPOXY RESIN
LEAD TREATMENT	SOLDER PLATING
LEAD MATERIAL	COPPER ALLOY
PACKAGE MASS	0.2g

SCT Ass'y
Kokubu Ass'y

16PIN SOP (PLASTIC)

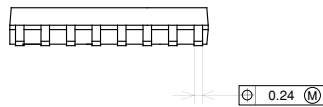
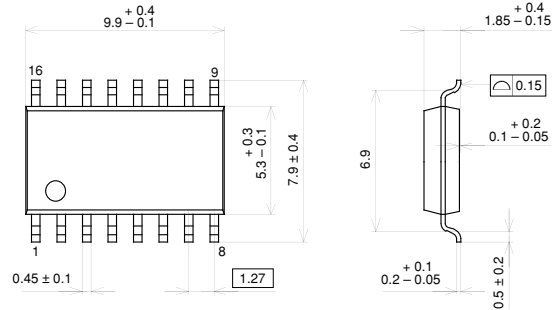

PACKAGE STRUCTURE

SONY CODE	SOP-16P-L01
EIAJ CODE	SOP016-P-0300
JEDEC CODE	

PACKAGE MATERIAL	EPOXY RESIN
LEAD TREATMENT	SOLDER PLATING
LEAD MATERIAL	COPPER ALLOY
PACKAGE MASS	0.2g

LEAD PLATING SPECIFICATIONS

ITEM	SPEC.
LEAD MATERIAL	COPPER ALLOY
SOLDER COMPOSITION	Sn-Bi Bi:1-4wt%
PLATING THICKNESS	5-18 μ m

Package Outline Unit : mm

CXA1550P, CXA1551P
CXA1552P, CXA1553P

16PIN DIP (PLASTIC)

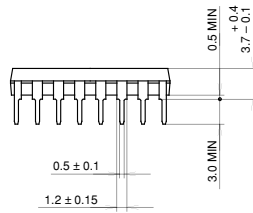
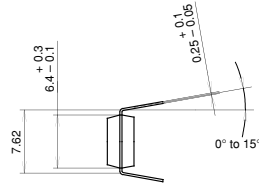
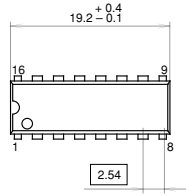

Two kinds of package surface:
1. All mat surface type.
2. All mirror surface type.

PACKAGE STRUCTURE

SONY CODE	DIP-16P-01
EIAJ CODE	DIP016-P-0300
JEDEC CODE	Similar to MO-001-AE

PACKAGE MATERIAL	EPOXY RESIN
LEAD TREATMENT	SOLDER PLATING
LEAD MATERIAL	COPPER ALLOY
PACKAGE MASS	1.0 g

PEC Ass'y

16PIN DIP (PLASTIC)

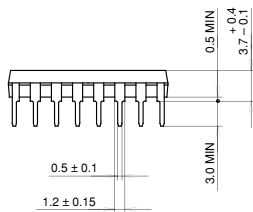
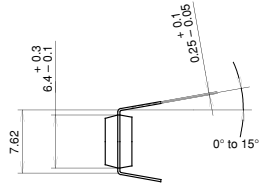
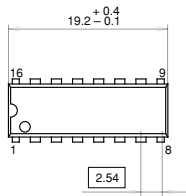

Two kinds of package surface:
1. All mat surface type.
2. All mirror surface type.

PACKAGE STRUCTURE

SONY CODE	DIP-16P-01
EIAJ CODE	DIP016-P-0300
JEDEC CODE	Similar to MO-001-AE

PACKAGE MATERIAL	EPOXY RESIN
LEAD TREATMENT	SOLDER PLATING
LEAD MATERIAL	COPPER ALLOY
PACKAGE MASS	1.0 g

LEAD PLATING SPECIFICATIONS

ITEM	SPEC.
LEAD MATERIAL	COPPER ALLOY
SOLDER COMPOSITION	Sr-Bi Bi:1-4wt%
PLATING THICKNESS	5-18µm