

## IGBT MODULE

### ■ Features

- Square RBSOA
- Low Saturation Voltage
- Less Total Power Dissipation
- Improved FWD Characteristic
- Minimized Internal Stray Inductance

### ■ Applications

- High Power Switching
- A.C. Motor Controls
- D.C. Motor Controls
- Uninterruptible Power Supply

## ■ Outline Drawing

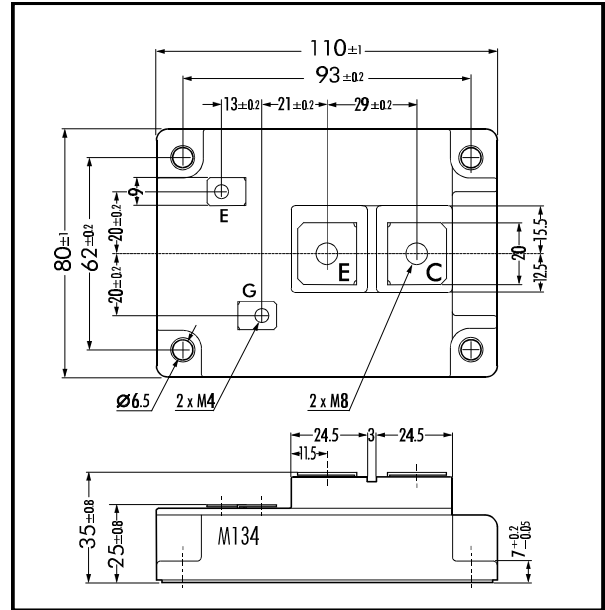

## ■ Maximum Ratings and Characteristics

### • Absolute Maximum Ratings (T<sub>c</sub>=25°C)

Items	Symbols	Ratings	Units
Collector-Emitter Voltage	V <sub>CEs</sub>	1200	V
Gate -Emitter Voltage	V <sub>GES</sub>	± 20	V
Collector Current	Continuous (25°C / 80°C)	I <sub>C</sub>	800 / 600
	1ms (25°C / 80°C)	I <sub>C PULSE</sub>	1600 / 1200
	Continuous	-I <sub>C</sub>	600
	1ms	-I <sub>C PULSE</sub>	1200
Max. Power Dissipation	P <sub>C</sub>	4100	W
Operating Temperature	T <sub>j</sub>	+150	°C
Storage Temperature	T <sub>stg</sub>	-40 ~ +125	°C
Isolation Voltage	A.C. 1min. V <sub>is</sub>	2500	V
Screw Torque	Mounting *1	4.5	Nm
	Terminals *2	11.0	
	Terminals *3	1.7	

Note: \*1:Recommendable Value; 4.0 ± 0.5 Nm (M6)  
\*2:Recommendable Value; 10.0 ± 1.0 Nm (M8)  
\*3:Recommendable Value; 1.5 ± 0.2 Nm (M4)

## ■ Equivalent Circuit

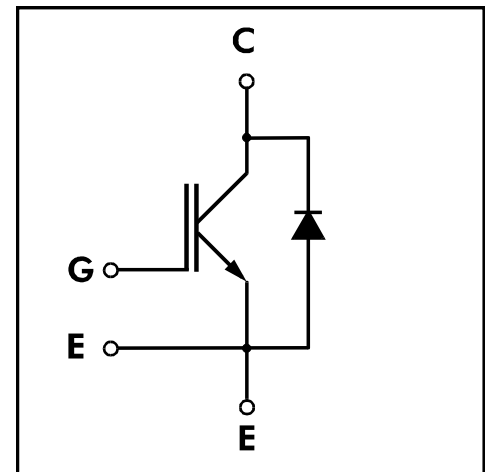

### • Electrical Characteristics (at T<sub>j</sub>=25°C)

Items	Symbols	Test Conditions	Min.	Typ.	Max.	Units
Zero Gate Voltage Collector Current	I <sub>CEs</sub>	V <sub>GE</sub> =0V V <sub>CE</sub> =1200V			2.0	mA
Gate-Emitter Leakage Current	I <sub>GES</sub>	V <sub>CE</sub> =0V V <sub>GE</sub> =± 20V			± 0.5	μA
Gate-Emitter Threshold Voltage	V <sub>GE(th)</sub>	V <sub>GE</sub> =20V I <sub>C</sub> =600mA	7.0	8.0	9.0	V
Collector-Emitter Saturation Voltage	V <sub>CE(sat)</sub>	V <sub>GE</sub> =15V I <sub>C</sub> =600A		2.85	3.2	V
Input capacitance	C <sub>ies</sub>	V <sub>GE</sub> =0V		60		nF
Output capacitance	C <sub>oes</sub>	V <sub>CE</sub> =10V		9		
Reverse Transfer capacitance	C <sub>res</sub>	f=1MHz		4		
Turn-on Time	t <sub>ON</sub>	V <sub>CC</sub> =600V		0.75	1.20	μs
	t <sub>r</sub>	I <sub>C</sub> =600A		0.02	0.60	
Turn-off Time	t <sub>OFF</sub>	V <sub>GE</sub> =± 15V		0.65	1.00	
	t <sub>f</sub>	R <sub>G</sub> =2.0Ω		0.01	0.30	
Diode Forward On-Voltage	V <sub>F</sub>	I <sub>F</sub> =600A V <sub>GE</sub> =0V			3.4	V
Reverse Recovery Time	t <sub>rr</sub>	I <sub>F</sub> =600A, V <sub>GE</sub> =-15V			350	ns

### • Thermal Characteristics

Items	Symbols	Test Conditions	Min.	Typ.	Max.	Units
Thermal Resistance	R <sub>th(j-c)</sub>	IGBT			0.03	°C/W
	R <sub>th(j-e)</sub>	Diode			0.06	
	R <sub>th(c-f)</sub>	With Thermal Compound		0.0063		

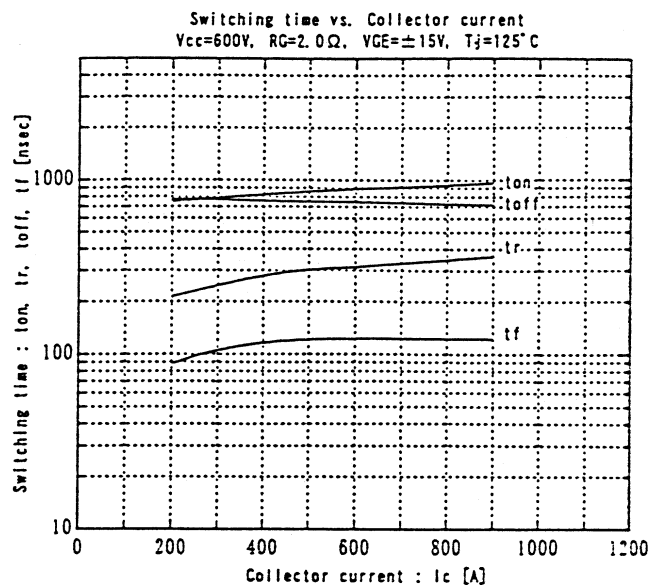
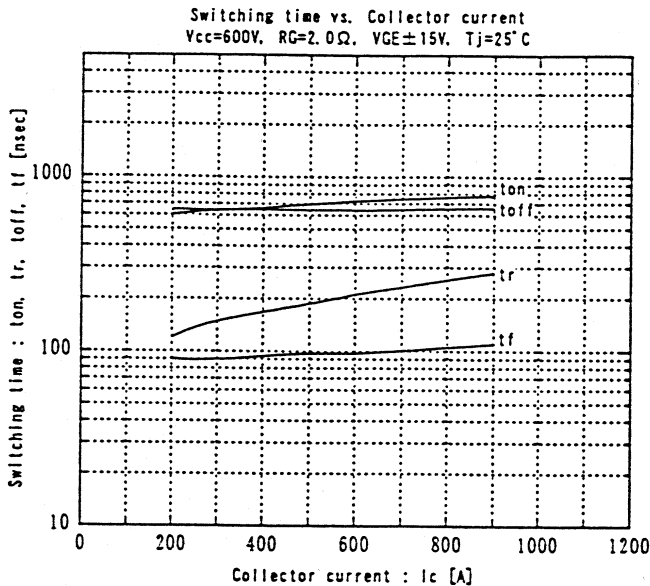
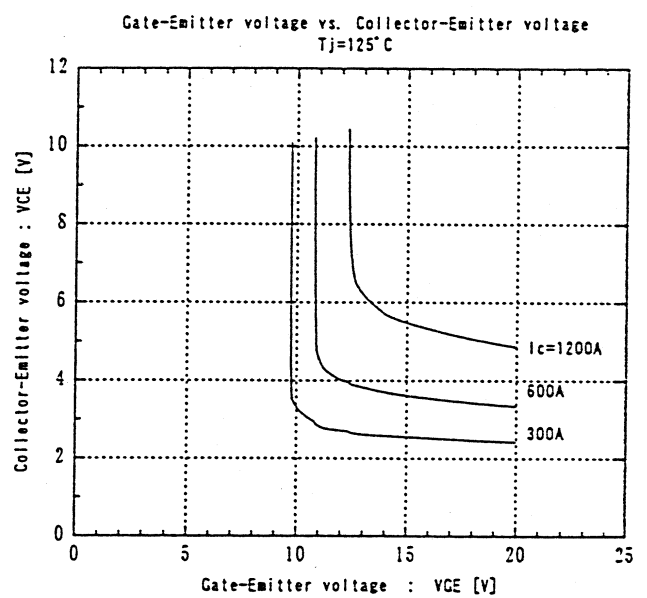
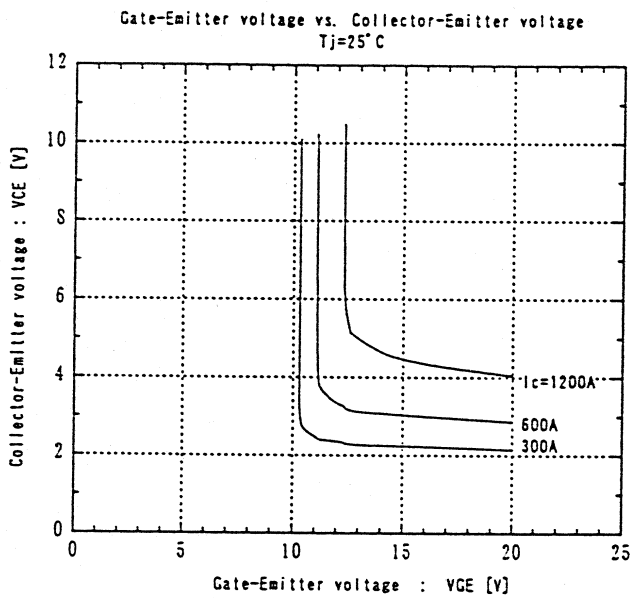
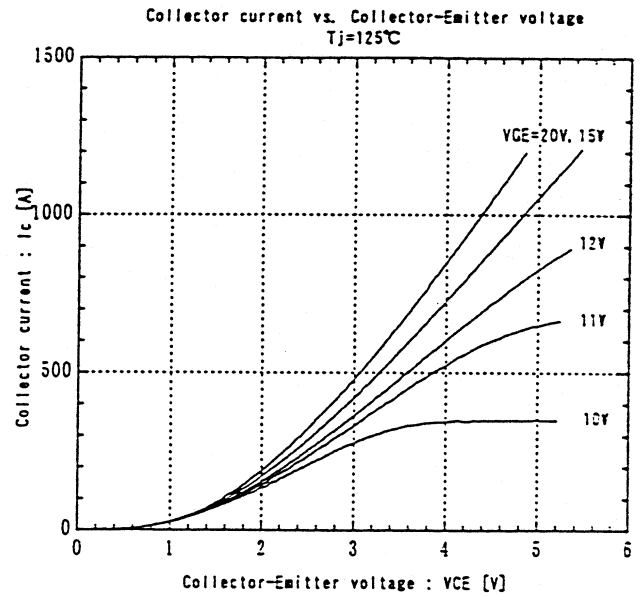
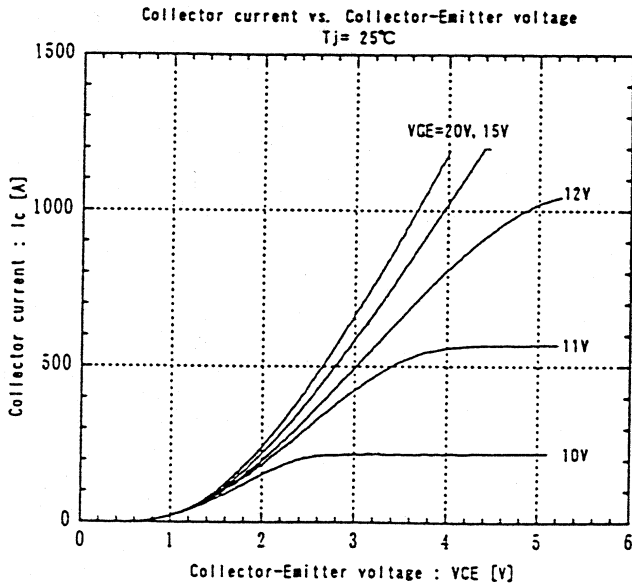

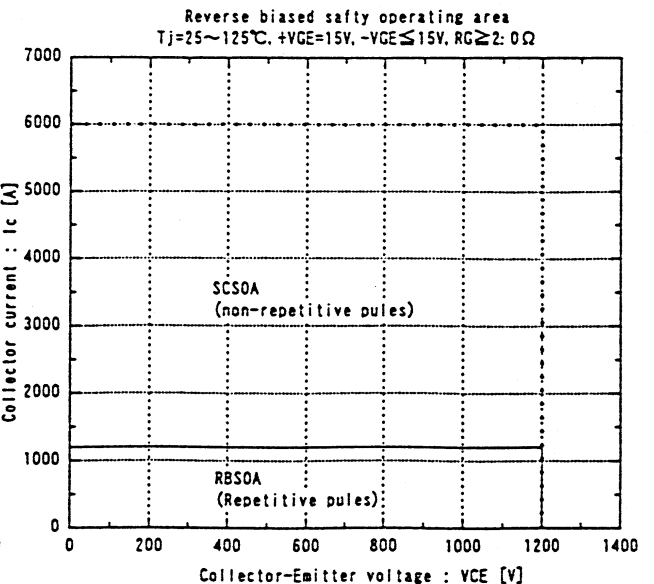
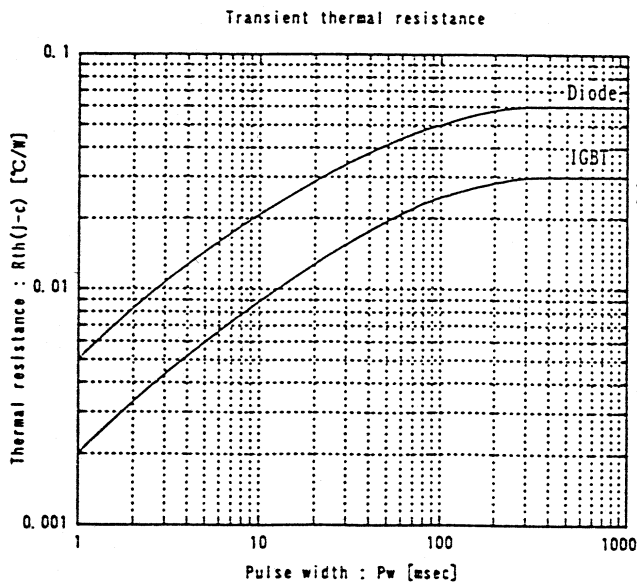
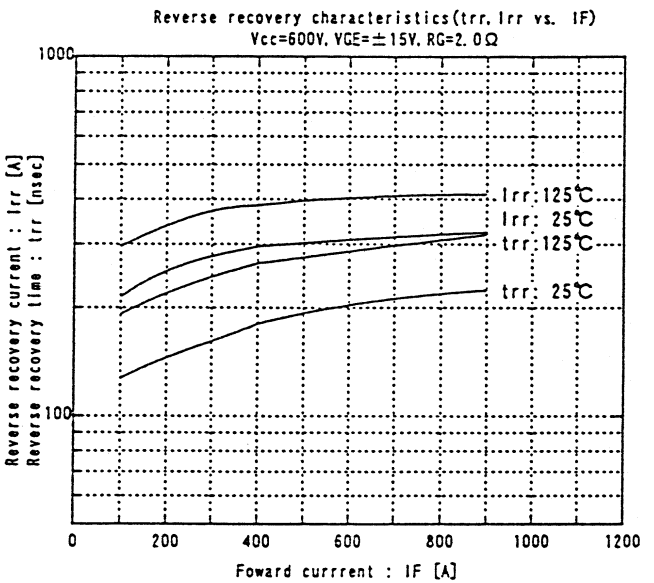
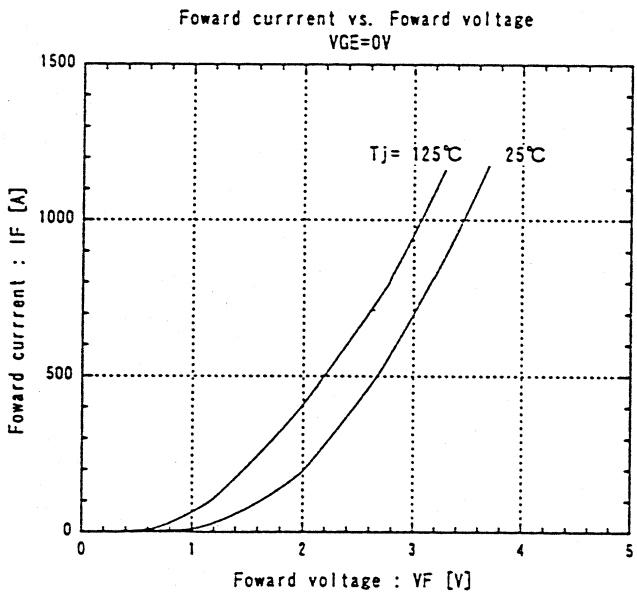
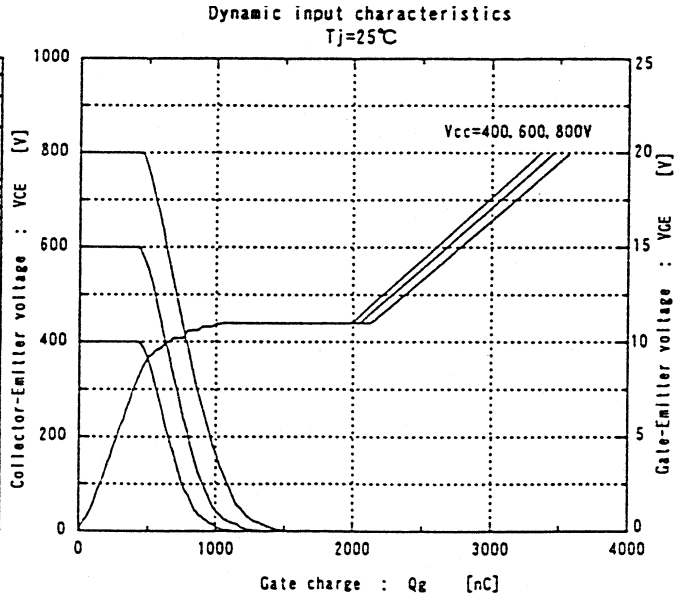
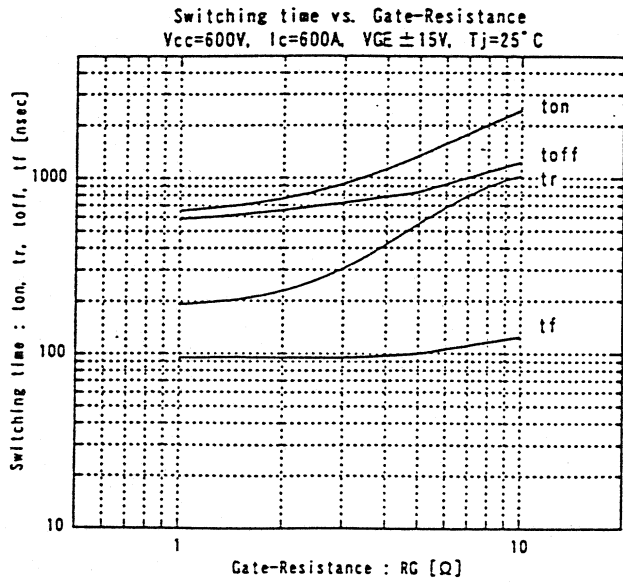

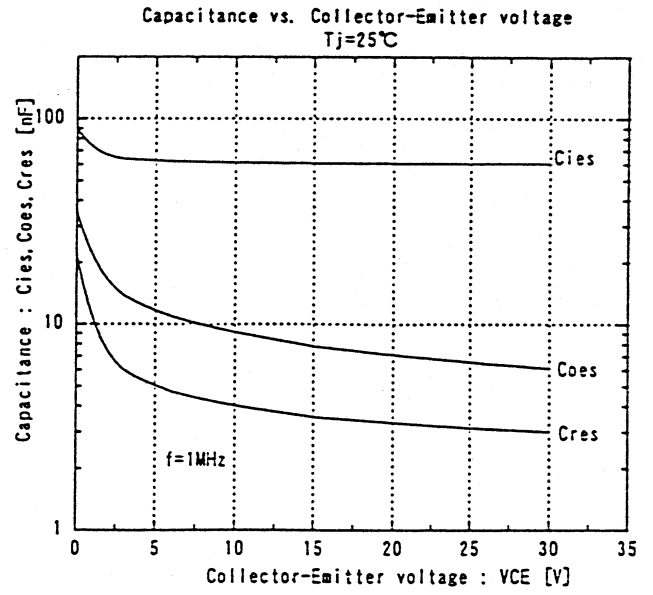
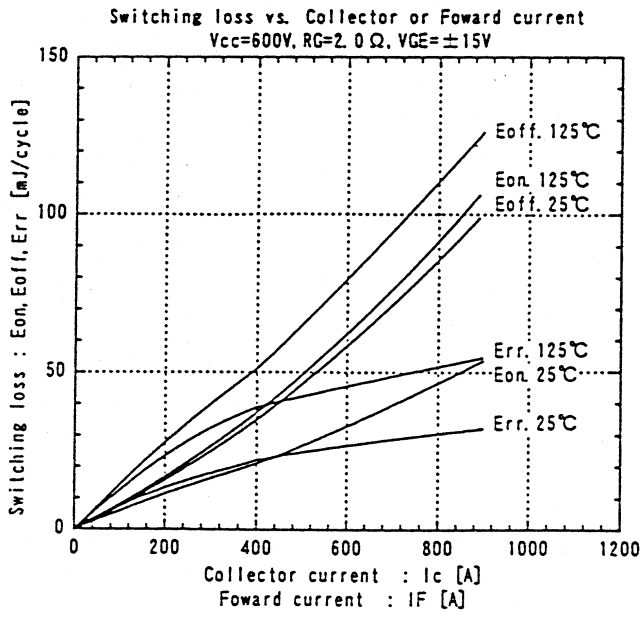

For more information, contact:

**Collmer Semiconductor, Inc.**

P.O. Box 702708

Dallas, TX 75370

972-233-1589

972-233-0481 Fax

<http://www.collmer.com>