

**Silicon Schottky Diode**
**Preliminary data**

- DBS mixer applications up to 12 GHz
- Low noise figure
- Low barrier type

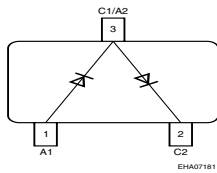
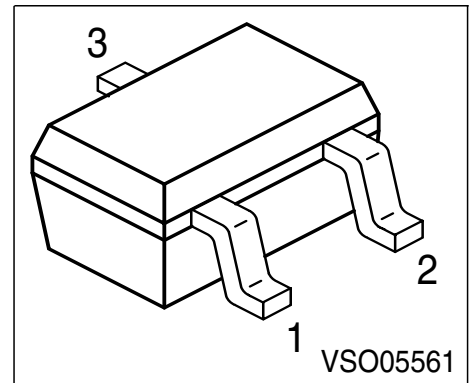

**ESD: Electrostatic discharge sensitive device, observe handling precaution!**

Type	Marking	Pin Configuration			Package
BAT 15-04W	S8s	1 = A1	2=C2	3=C1/A2	SOT-323

**Maximum Ratings**

Parameter	Symbol	Value	Unit
Diode reverse voltage	$V_R$	4	V
Forward current	$I_F$	110	mA
Total power dissipation, $T_S \leq \text{tbd } ^\circ\text{C}$	$P_{\text{tot}}$	100	mW
Junction temperature	$T_j$	150	$^\circ\text{C}$
Operating temperature range	$T_{\text{op}}$	-55 ... 150	$^\circ\text{C}$
Storage temperature	$T_{\text{stg}}$	-55 ... 150	$^\circ\text{C}$

**Thermal Resistance**

Junction - ambient <sup>1)</sup>	$R_{\text{thJA}}$	$\leq \text{tbd}$	K/W
Junction - soldering point	$R_{\text{thJS}}$	$\leq \text{tbd}$	

1) Package mounted on alumina 15mm x 17.6mm x 0.7mm)

**Electrical Characteristics** at  $T_A = 25\text{ }^\circ\text{C}$ , unless otherwise specified.

Parameter	Symbol	Values			Unit
		min.	typ.	max.	
<b>DC characteristics</b>					
Breakdown voltage $I_{(BR)} = 5\text{ }\mu\text{A}$	$V_{(BR)}$	4	-	-	V
Forward voltage $I_F = 1\text{ mA}$ $I_F = 10\text{ mA}$	$V_F$	- -	0.23 -	0.32 0.4	
Forward voltage matching <sup>1)</sup> $I_F = 10\text{ mA}$	$\Delta V_F$	-	-	20	mV
<b>AC characteristics</b>					
Diode capacitance $V_R = 0\text{ V}$ , $f = 1\text{ MHz}$	$C_T$	-	-	0.35	pF
Forward resistance $I_F = 10\text{ mA} / 50\text{ mA}$	$R_F$	-	5.5	-	$\Omega$

1)  $\Delta V_F$  is difference between lowest and highest  $V_F$  in component

**Forward current  $I_F = f(V_F)$**

$T_A =$  Parameter

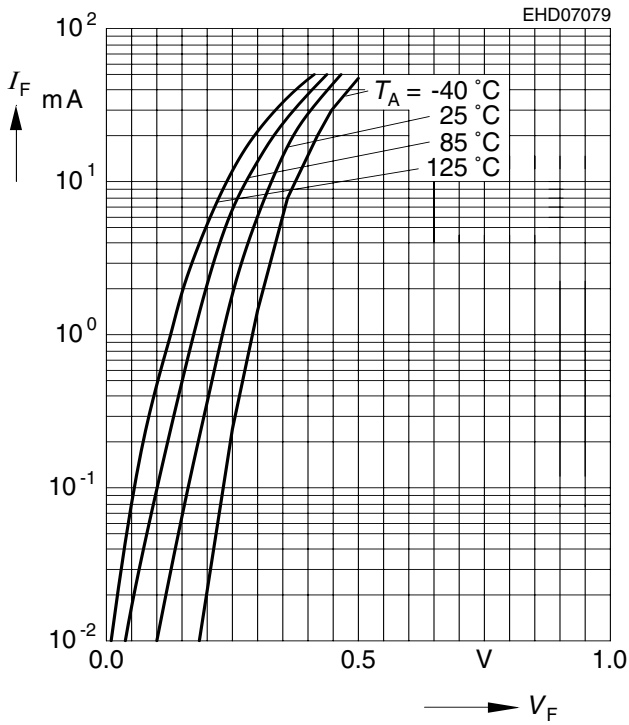

**Reverse current  $I_R = f(V_R)$**

$T_A =$  Parameter

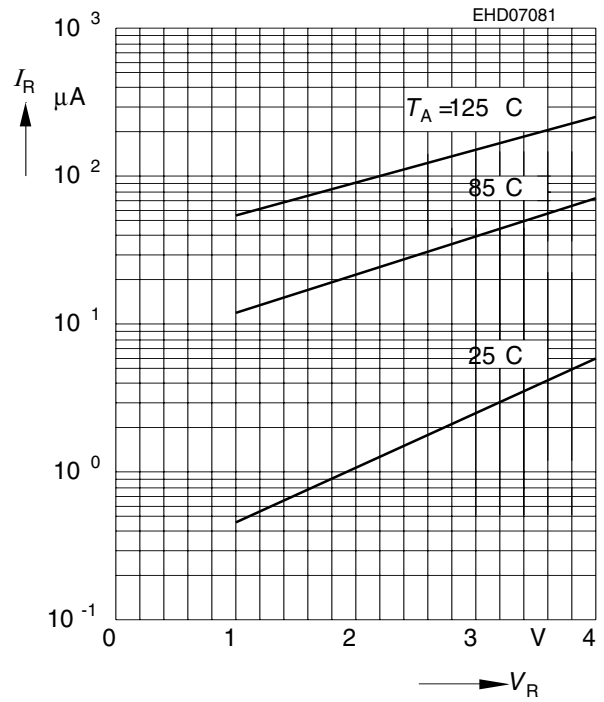

**Diode capacitance  $C_T = f(V_R)$**

$f = 1\text{MHz}$

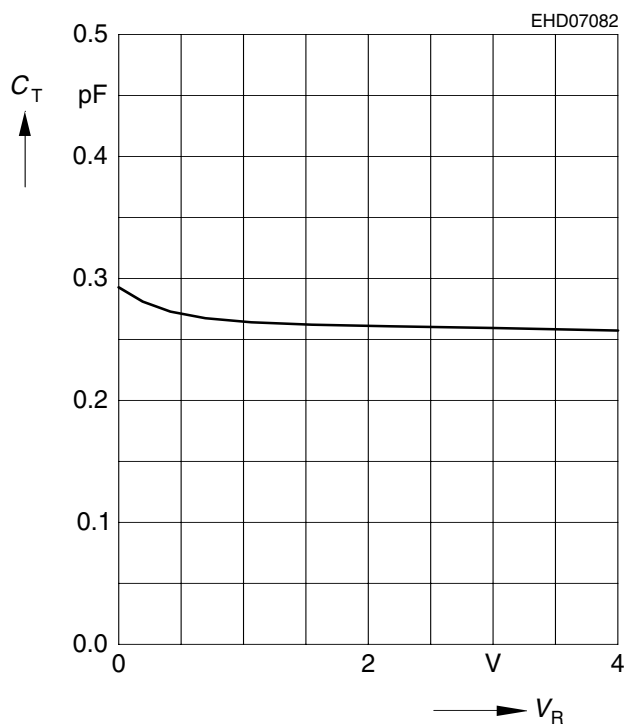

Forward current  $I_F = f(T_A^*; T_S)$

\* Package mounted on epoxy

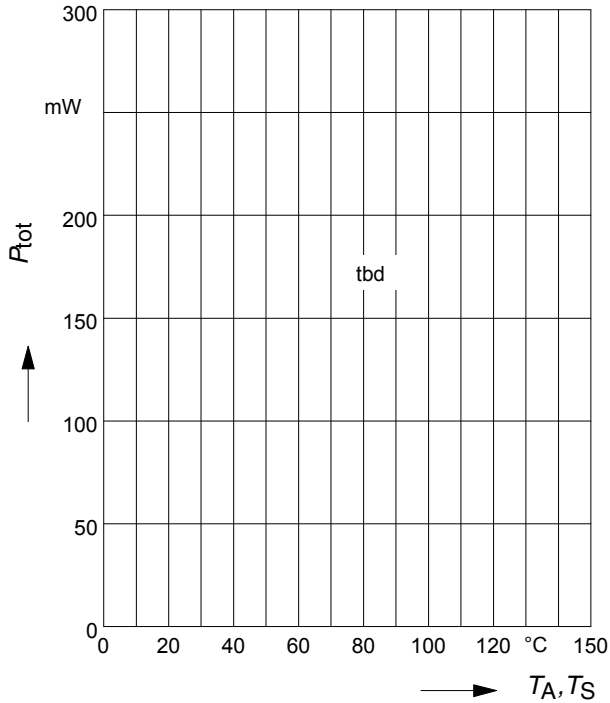

Permissible Pulse Load  $R_{thJS} = f(t_p)$

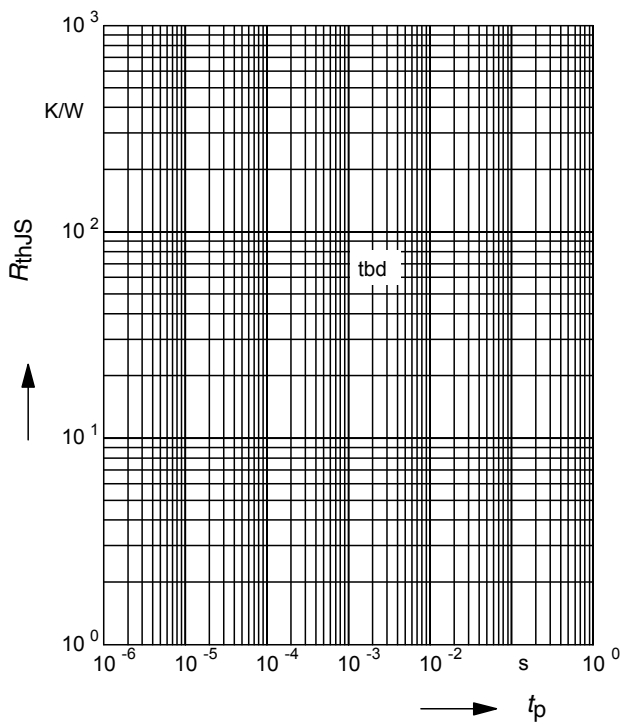

Permissible Pulse Load

$I_{Fmax} / I_{FDC} = f(t_p)$

