

New Product Announcement

8 & 16 Amp Schottky Rectifiers

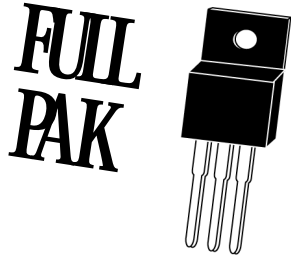

in a
TO-220FP
package

Sample Devices
available
upon request.

Features

- Fully isolated tab eliminates need for additional insulation on circuit board.
- Available in both single and dual (common cathode) configurations.
- Also available in Surface Mount packages.

Rectifiers, Schottky

8.0 to 16 Amperes
40 to 100 Volts

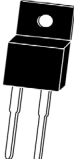
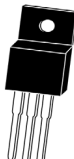
I _O (AMPS)	8.0	16
@ T _C (°C)	100	90
I _{FSM} (AMPS)	150	150
		
	SINGLE	DUAL
V _{RRM} (Volts)		
40	CRSH-40FP	CRSH16-40FP
60	CSHDD8-60FP	CRSH16-60FP
100	CSHDD8-100FP	CRSH16-100FP
V _F MAX @ I _F = I _O @ T _C = 125°C		
40V	0.57V	0.72V
60V	0.65V	0.85V
100V	0.75V	1.00V

Rectifiers, Ultra Fast

8.0 to 16 Amperes
200 to 800 Volts

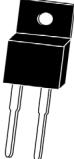
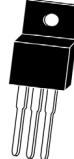
I _O (AMPS)	8.0	16
@ T _A (°C)	25	25
I _{FSM} (AMPS)		
		
	SINGLE	DUAL
V _{RRM} (Volts)		
200	CR8U-02FP	CR16UD-02FP
400	CR8U-04FP	CR16UD-04FP
800	CR8U-08FP	CR16UD-08FP

V _F MAX @ I _F = I _O @ T _C = 150°C		
200V	0.895V	0.895V @ 8.0A
400V	1.1V	1.1V @ 8.0A
800V	1.2V	1.2V @ 8.0A

I _R MAX @ V _{RRM}	5.0µA*	5.0µA *
t _{rr} (200V)	25 ns	25 ns
t _{rr} (400V)	25 ns	25 ns
t _{rr} (800V)	50 ns	50 ns

* 200 Volt device

CentralTM
Semiconductor Corp.

145 Adams Avenue, Hauppauge, New York 11788 USA
Tel: (631) 435-1110 • Fax: (631) 435-1824
www.centrasemi.com

Schottky & Ultra Fast Rectifiers TO-220FP

All Dimensions in inches (mm).

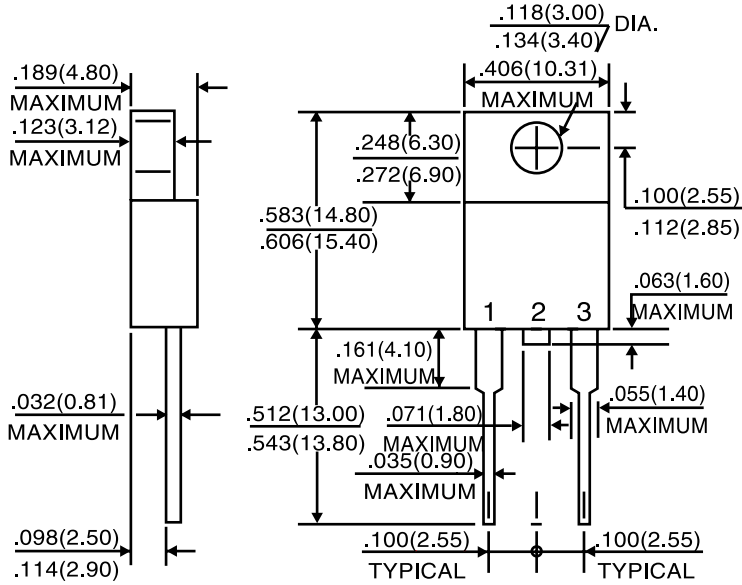

All Dimensions in inches (mm).

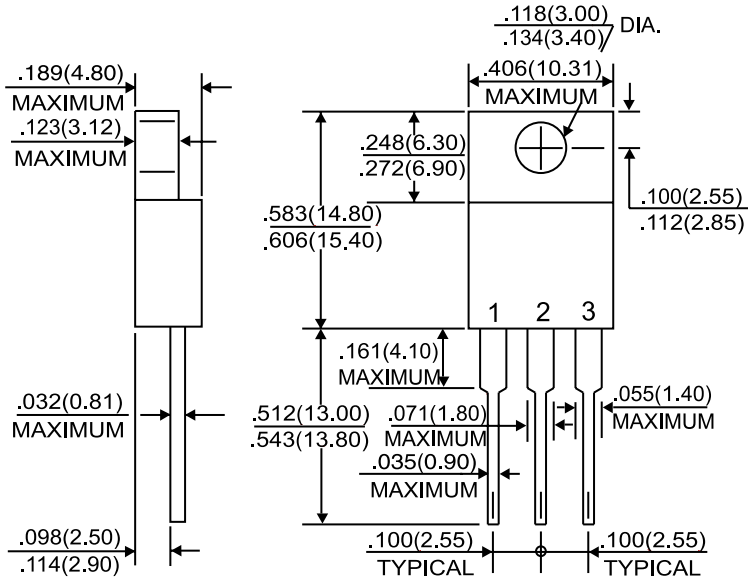

Central™
Semiconductor Corp.

Dedicated to Complete Customer Satisfaction

145 Adams Avenue
Hauppauge, NY 11788 USA
Phone (631) 435-1110
Fax (631) 435-1824
www.centrasemi.com
PA TO-220FP