



LC72323-XXXX

Provisional Development Specifications

Preliminary



Overview

The LC72323-XXXX is a single-chip car audio system electronic tuning controller that supports detachable function block systems. This product supports reception in all areas of the world and include PLL, LCD driver and electronic volume/tone control support circuits on chip.

Features

- Support for reception of the European FM, MW and LW bands and the FM and AM bands used in the US, Australia, the Middle and Near East and South America
- Support for electronic volume/tone controls (bass, treble, balance and fader) using the LC75371M
- VF seek and auto retune functions (Europe)
- Support for IF counting techniques in all bands
- Automatic memory function in station strength order (FM band)
- Loudness control
- CD functions
 - Key inputs
 - CD indicator display function
- Tape functions
 - Tape indicator display function
 - Dolby, APSS and metal tape controls
- Clock function with 24-hour display for Europe and 12-hour display for other reception areas
- Single 5 V power supply
- Package: QFP80E (QIP80E)
- Telephone mute function
- LED blinking function

Package Dimensions

unit: mm

3174-QFP80E

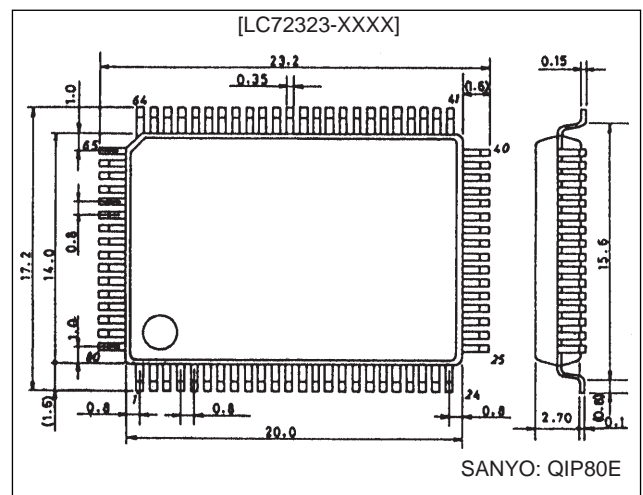

This LSI can easily use CCB that is SANYO's original bus format.



- CCB is a trademark of SANYO ELECTRIC CO., LTD.
- CCB is SANYO's original bus format and all the bus addresses are controlled by SANYO.

SANYO Electric Co.,Ltd. Semiconductor Business Headquarters

TOKYO OFFICE Tokyo Bldg., 1-10, 1 Chome, Ueno, Taito-ku, TOKYO, 110 JAPAN

LC72323-XXXX

Specifications

Absolute Maximum Ratings at $T_a = 25^\circ\text{C}$, $V_{SS} = 0\text{ V}$

Parameter	Symbol	Conditions	Ratings	Unit
Maximum supply voltage	$V_{DD\text{ max}}$		-0.3 to +6.5	V
Input voltage	$V_{IN\ (1)}$	HOLD, $\overline{\text{TELIN}}$, RES, SNS, ADI, SD, ST, SK, DK	-0.3 to +13	V
	$V_{IN\ (2)}$	Inputs other than $V_{IN\ (1)}$	-0.3 to $V_{DD} + 0.3$	V
Output voltage	$V_{OUT\ (1)}$	BEEP, BAND2, BAND1, $\overline{\text{POWER}}$	-0.3 to +15	V
	$V_{OUT\ (2)}$	Outputs other than $V_{OUT\ (1)}$	-0.3 to $V_{DD} + 0.3$	V
Output current	$I_{OUT\ (1)}$	$\overline{\text{AMUTE}}$, LEDFL, DI/KS9, CLK/KS8, BEEP, BAND2, BAND1, $\overline{\text{POWER}}$	0 to 5	mA
	$I_{OUT\ (2)}$	DOLBY, METAL, APSS, LOUDNESS, LOCAL, STEREO	0 to 3	mA
	$I_{OUT\ (3)}$	KS0, KS1, KS2, KS3, KS4, KS5, KS6, CE/KS7	0 to 1	mA
Allowable power dissipation	$P_d\text{ max}$	$T_a = -40\text{ to }+85^\circ\text{C}$	300*	mW
Operating temperature	Topr		-40 to +85	$^\circ\text{C}$
Storage temperature	Tstg		-45 to +125	$^\circ\text{C}$

Note: * Reference value

Allowable Operating Ranges at $T_a = -40\text{ to }+85^\circ\text{C}$, $V_{DD} = 3.5\text{ to }5.5\text{ V}$

Parameter	Symbol	Conditions	Ratings			Unit
			min	typ	max	
Supply voltage	$V_{DD\ (1)}$	With the CPU and PLL operating	4.5		5.5	V
	$V_{DD\ (2)}$	CPU operating	3.5		5.5	V
	$V_{DD\ (3)}$	Memory retention	1.3		5.5	V
Input high level voltage	$V_{IH\ (1)}$	SK, DK, $\overline{\text{SD}}$, $\overline{\text{ST}}$	$0.7 V_{DD}$		8.0	V
	$V_{IH\ (2)}$	$\overline{\text{RES}}$, $\overline{\text{INT}}$, $\overline{\text{HOLD}}$	$0.8 V_{DD}$		8.0	V
	$V_{IH\ (3)}$	$\overline{\text{SNS}}$	2.5		8.0	V
	$V_{IH\ (4)}$	K0, K1, K2, K3	$0.6 V_{DD}$		V_{DD}	V
	$V_{IH\ (5)}$	$\overline{\text{TAPE}}$, TAPERUN	$0.7 V_{DD}$		V_{DD}	V
Input low level voltage	$V_{IL\ (1)}$	SK, DK, $\overline{\text{SD}}$, $\overline{\text{ST}}$	0		$0.3 V_{DD}$	V
	$V_{IL\ (2)}$	$\overline{\text{RES}}$, $\overline{\text{INT}}$	0		$0.2 V_{DD}$	V
	$V_{IL\ (3)}$	$\overline{\text{SNS}}$	0		1.3	V
	$V_{IL\ (4)}$	K0, K1, K2, K3	0		$0.2 V_{DD}$	V
	$V_{IL\ (5)}$	$\overline{\text{TAPE}}$, TAPERUN	0		$0.3 V_{DD}$	V
	$V_{IL\ (6)}$	$\overline{\text{HOLD}}$	0		$0.4 V_{DD}$	V
Input frequency	$F_{IN\ (1)}$	XIN	4.0	4.5	5.0	MHz
	$F_{IN\ (2)}$	FM OSC, $V_{IN\ (2)}$, $V_{DD\ (1)}$	10		130	MHz
	$F_{IN\ (3)}$	AM OSC, $V_{IN\ (3)}$, $V_{DD\ (1)}$	0.5		10	MHz
	$F_{IN\ (4)}$	FMIF, $V_{IN\ (4)}$, $V_{DD\ (1)}$	0.4		12	MHz
	$F_{IN\ (5)}$	AMIF, $V_{IN\ (4)}$, $V_{DD\ (1)}$	100		500	kHz
Input amplitude	$V_{IN\ (1)}$	XIN	0.50		1.5	Vrms
	$V_{IN\ (2)}$	FM OSC	0.10		1.5	Vrms
	$V_{IN\ (3)}$	AM OSC	0.10		1.5	Vrms
	$V_{IN\ (4)}$	FMIF, AMIF	0.10		1.5	Vrms
Input voltage range	$V_{IN\ (5)}$	ADI	0		V_{DD}	V

LC72323-XXXX

Electrical Characteristics for the Allowable Operating Ranges

Parameter	Symbol	Conditions	Ratings			Unit
			min	typ	max	
Power down detection voltage	VDET		2.7	3.0	3.3	V
Input high level current	I _{IH} (1)	$\overline{\text{TELIN}}$, $\overline{\text{HOLD}}$, $\overline{\text{RES}}$, $\overline{\text{ADI}}$, $\overline{\text{SNS}}$, $\overline{\text{SK}}$, $\overline{\text{DK}}$, $\overline{\text{SD}}$, $\overline{\text{ST}}$: V _I = 5.5 V			3.0	μA
	I _{IH} (2)	XIN: V _I = V _{DD} = 5.0 V	2.0	5.0	15	μA
	I _{IH} (3)	FM OSC, AM OSC, FMIF, AMIF: V _I = V _{DD} = 5.0 V	4.0	10	30	μA
	I _{IH} (4)	K0, K1, K2, K3: V _I = V _{DD} = 5.0 V		50		μA
	I _{IH} (5)	$\overline{\text{TAPE}}$, $\overline{\text{TAPERUN}}$: V _I = V _{DD}			3.0	μA
Input low level current	I _{IL} (1)	$\overline{\text{TELIN}}$, $\overline{\text{HOLD}}$, $\overline{\text{RES}}$, $\overline{\text{ADI}}$, $\overline{\text{SNS}}$, $\overline{\text{SK}}$, $\overline{\text{DK}}$, $\overline{\text{SD}}$, $\overline{\text{ST}}$: V _I = V _{SS}			3.0	μA
	I _{IL} (2)	XIN: V _I = V _{SS}	2.0	5.0	15	μA
	I _{IL} (3)	FM OSC, AM OSC, FMIF, AMIF: V _I = V _{SS}	4.0	10	30	μA
	I _{IL} (4)	$\overline{\text{TAPE}}$, $\overline{\text{TAPERUN}}$: V _I = V _{SS}			3.0	μA
Input floating voltage	VIF	K0, K1, K2, K3			0.05 V _{DD}	V
Pull-down resistance	RPD	K0, K1, K2, K3: V _{DD} = 5 V	75	100	200	kΩ
Output off leakage current	I _{OFFH} (1)	EO1, EO2: V _O = V _{DD}		0.01	10	nA
	I _{OFFH} (2)	KS0 to KS6, CE/KS7, CLK/KS8, DI/KS9, LEDFL, $\overline{\text{AMUTE}}$, LOUDNESS, APSS, METAL, DOLBY, STEREO, LOCAL: V _O = V _{DD}			3.0	μA
	I _{OFFH} (3)	BAND1, BAND2, BEEP, $\overline{\text{POWER}}$: V _O = 13 V			5.0	μA
Output off leakage current	I _{OFFL} (1)	EO1, EO2: V _O = V _{SS}		0.01	10	nA
	I _{OFFL} (2)	KS0 to KS6, CE/KS7, CLK/KS8, DI/KS9, LEDFL, $\overline{\text{AMUTE}}$, LOUDNESS, APSS, METAL, DOLBY, STEREO, LOCAL: V _O = V _{SS}			3.0	μA
Output high level voltage	V _{OH} (1)	KS0 to KS6, CE/KS7: I _O = 1 mA	V _{DD} - 2.0	V _{DD} - 1.0	V _{DD} - 0.5	V
	V _{OH} (2)	LOUDNESS, APSS, METAL, DOLBY, STEREO, LOCAL: I _O = 1 mA	V _{DD} - 1.0			V
	V _{OH} (3)	EO1, EO2: I _O = 500 μA	V _{DD} - 1.0			V
	V _{OH} (4)	XOUT: I _O = 200 μA	V _{DD} - 1.0			V
	V _{OH} (5)	S1 to S28: I _O = 0.1 mA	V _{DD} - 1.0			V
	V _{OH} (6)	COM1, COM2: I _O = 25 μA	V _{DD} - 0.75	V _{DD} - 0.5	V _{DD} - 0.3	V
	V _{OH} (7)	$\overline{\text{AMUTE}}$, LEDFL, CLK/KS8, DI/KS9: I _O = 5 mA	V _{DD} - 1.0			V
Output low level voltage	V _{OL} (1)	KS0 to KS6, CE/KS7: I _O = 50 μA	0.5	1.0	2.0	V
	V _{OL} (2)	LOUDNESS, APSS, METAL, DOLBY, STEREO, LOCAL: I _O = 1 mA			1.0	V
	V _{OL} (3)	EO1, EO2: I _O = 500 μA			1.0	V
	V _{OL} (4)	XOUT: I _O = 200 μA			1.0	V
	V _{OL} (5)	S1 to S28: I _O = 0.1 mA			1.0	V
	V _{OL} (6)	$\overline{\text{AMUTE}}$, LEDFL, CLK/KS8, DI/KS9: I _O = 5 mA			1.0	V
	V _{OL} (7)	COM1, COM2: I _O = 25 μA	0.3	0.5	0.75	V
	V _{OL} (8)	BAND1, BAND2, BEEP, $\overline{\text{POWER}}$: I _O = 5 mA	0.75 (150 Ω)		2.0 (400 Ω)	V
Output mid-level voltage	VM	COM1, COM2, V _{DD} = 5 V, I _O = 20 μA	2.0	2.5	3.0	V
Current drain	I _{DD} (1)	V _{DD} (1), F _{IN} (2) = 130 MHz		15	20	mA
	I _{DD} (2)	V _{DD} (2), PLL stopped, (hold mode, Figure 1)		1.0		mA
	I _{DD} (3)	V _{DD} = 5.5 V, oscillator stopped, Ta = 25°C (backup mode, Figure 2)			5	μA
	I _{DD} (4)	V _{DD} = 2.5 V, oscillator stopped, Ta = 25°C (backup mode, Figure 2)			1	μA

LC72323-XXXX

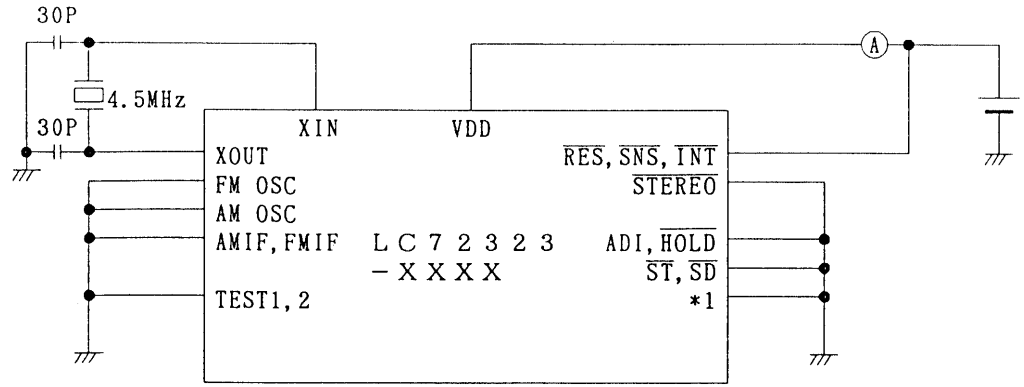

Unit (capacitance: F)

*1: K0, K1, K2, K3, TAPE, TAPERUN

Note: BEEP, BAND2, BAND1, POWER, LOCAL, STEREO, DOLBY, METAL, APSS, LOUDNESS, AMUTE, LEDFL, DI/KS9, CLK/KS8, CE/KS7, KS0 to KS6 = "Open"

Figure 1 I_{DD} (2) in Hold Mode

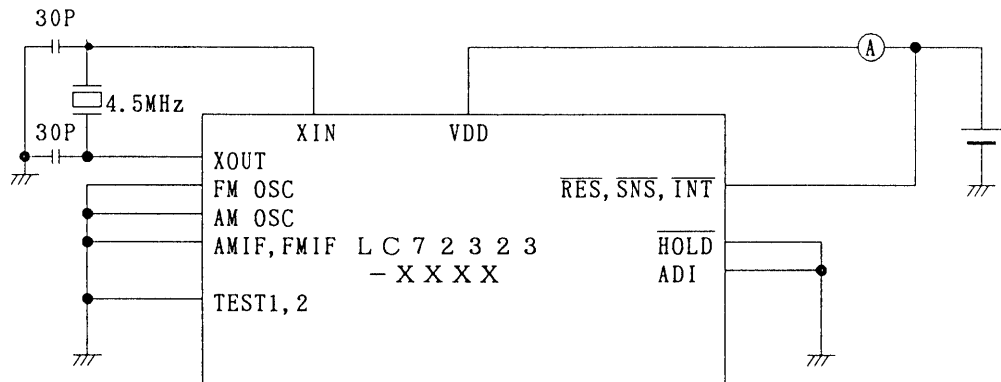

Unit (capacitance: F)

Note: With all ports other than those specifically mentioned left open

Figure 2 I_{DD} (3) in Backup Mode

LC72323-XXXX

Pin Assignment

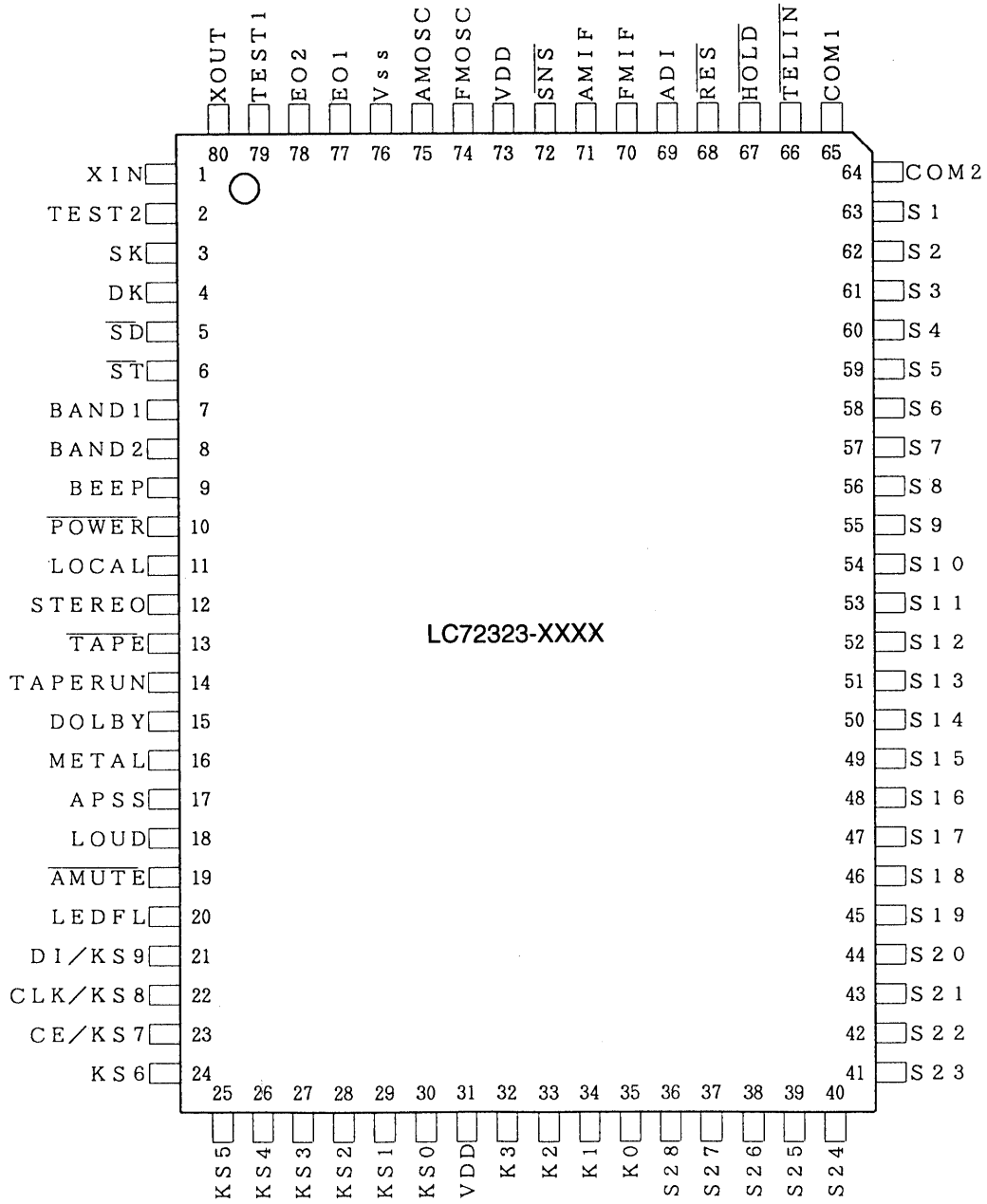

Top view

Reception Frequencies

Area	Band	Receiving frequency	Channel spacing		Reference frequency	IF	IF count tolerance
			Auto	Manual			
Europe 1	FM	87.5 – 108.0 MHz	50 kHz	50 kHz	25 kHz	10.7 MHz	±10 kHz
	MW	531 – 1602 kHz	9 kHz	9 kHz	9 kHz	459 kHz	±3 kHz
	LW	153 – 281 kHz		1 kHz	1 kHz		±0.6 kHz
Europe 2	MW	531 – 1602 kHz	9 kHz	9 kHz	9 kHz	459 kHz	±3 kHz
	LW	153 – 281 kHz		1 kHz	1 kHz		±0.6 kHz
Europe 3	FM	87.5 – 108.0 MHz	50 kHz	50 kHz	25 kHz	10.7 MHz	±10 kHz
	AM	531 – 1602 kHz	9 kHz	9 kHz	9 kHz	459 kHz	±3 kHz
USA 1	FM	87.9 – 107.9 MHz	200 kHz	200 kHz	25 kHz	10.7 MHz	±10 kHz
	AM	530 – 1710 kHz	10 kHz	10 kHz	10 kHz	450 kHz	±3 kHz
USA 2	FM	87.9 – 107.9 MHz	200 kHz	200 kHz	25 kHz	10.7 MHz	±10 kHz
	AM	530 – 1710 kHz	10 kHz	10 kHz	10 kHz	450 kHz	±3 kHz
Middle east/ Australia 1	FM	87.9 – 107.9 MHz	100 kHz	100 kHz	25 kHz	10.7 MHz	±10 kHz
	AM	531 – 1602 kHz	9 kHz	9 kHz	9 kHz	450 kHz	±3 kHz
Middle east/ Australia 2	FM	87.9 – 107.9 MHz	100 kHz	100 kHz	25 kHz	10.7 MHz	±10 kHz
	AM	531 – 1602 kHz	9 kHz	9 kHz	9 kHz	450 kHz	±3 kHz
South America	FM	87.5 – 108.0 MHz	100 kHz	100 kHz	25 kHz	10.7 MHz	±10 kHz
	AM	520 – 1620 kHz	10 kHz	10 kHz	10 kHz	450 kHz	±3 kHz

Key and Diode Matrix

	K3	K2	K1	K0
KS0	MAN UP/T UP	MAN DN/T DN	STEREO	DISP
KS1	SEEK UP	SEEK DOWN	SCAN UP	PS/AMEM
KS2	M1	M2	M3	M4/METAL
KS3	M5/DOLBY	M6/APSS	VF	BAND
KS4	V UP	V DOWN	LOUDNESS	LOCAL
KS5	CD	MODE	MUTE	POWER
KS6	AREA0 ▲	AREA1 ▲	AREA2 ▲	AREA3 ▲
KS7	COLON ▲	CD SEL ▲	DF SEL ▲	AUTO500 ▲
KS8	CLOCK ▲	IF0 ▲	PRIORITY ▲	FADER ▲
KS9	VR SEL ▲	POWSEL ▲	LEDSEL ▲	POWAMP ▲

⇒ Tact switch

⇒ Diode switch

LC72323-XXXX

Diode Switches

Diode matrix name	On/off	Function																																																																																																						
AREA0 AREA1 AREA2 AREA3		These diodes set the target reception area. The target reception area and bands are determined by the following combinations.																																																																																																						
		<table border="1"> <thead> <tr> <th>AREA3</th> <th>AREA2</th> <th>AREA1</th> <th>AREA0</th> <th>Area</th> <th>Band</th> </tr> </thead> <tbody> <tr> <td>0</td> <td>0</td> <td>0</td> <td>0</td> <td>Europe 1</td> <td>FM1/FM2/MW/LW</td> </tr> <tr> <td>0</td> <td>0</td> <td>0</td> <td>1</td> <td>Europe 2</td> <td>MW/LW</td> </tr> <tr> <td>0</td> <td>0</td> <td>1</td> <td>0</td> <td>Europe 3</td> <td>FM/AM</td> </tr> <tr> <td>0</td> <td>0</td> <td>1</td> <td>1</td> <td>South America</td> <td>FM1/FM2/AM</td> </tr> <tr> <td>0</td> <td>1</td> <td>0</td> <td>0</td> <td>USA 1</td> <td>FM1/FM2/AM</td> </tr> <tr> <td>0</td> <td>1</td> <td>0</td> <td>1</td> <td>USA 2</td> <td>FM1/FM2/FM3/AM</td> </tr> <tr> <td>0</td> <td>1</td> <td>1</td> <td>0</td> <td>Middle east/Australia 1</td> <td>FM1/FM2/AM</td> </tr> <tr> <td>0</td> <td>1</td> <td>1</td> <td>1</td> <td>Middle east/Australia 2</td> <td>FM1/FM2/FM3/AM</td> </tr> <tr> <td>1</td> <td>0</td> <td>0</td> <td>0</td> <td>Europe 1</td> <td>FM1/FM2/FM3</td> </tr> <tr> <td>1</td> <td>0</td> <td>0</td> <td>1</td> <td>Europe 3</td> <td>FM</td> </tr> <tr> <td>1</td> <td>0</td> <td>1</td> <td>0</td> <td>Europe 3</td> <td>FM1/FM2/FM3/AM</td> </tr> <tr> <td>1</td> <td>0</td> <td>1</td> <td>1</td> <td>South America</td> <td>FM1/FM2/FM3/AM</td> </tr> <tr> <td>1</td> <td>1</td> <td>0</td> <td>0</td> <td>USA 1</td> <td>FM1/FM2</td> </tr> <tr> <td>1</td> <td>1</td> <td>0</td> <td>1</td> <td>USA 2</td> <td>FM</td> </tr> <tr> <td>1</td> <td>1</td> <td>1</td> <td>0</td> <td>Middle east/Australia 1</td> <td>FM1/FM2</td> </tr> <tr> <td>1</td> <td>1</td> <td>1</td> <td>1</td> <td>Middle east/Australia 2</td> <td>FM</td> </tr> </tbody> </table>	AREA3	AREA2	AREA1	AREA0	Area	Band	0	0	0	0	Europe 1	FM1/FM2/MW/LW	0	0	0	1	Europe 2	MW/LW	0	0	1	0	Europe 3	FM/AM	0	0	1	1	South America	FM1/FM2/AM	0	1	0	0	USA 1	FM1/FM2/AM	0	1	0	1	USA 2	FM1/FM2/FM3/AM	0	1	1	0	Middle east/Australia 1	FM1/FM2/AM	0	1	1	1	Middle east/Australia 2	FM1/FM2/FM3/AM	1	0	0	0	Europe 1	FM1/FM2/FM3	1	0	0	1	Europe 3	FM	1	0	1	0	Europe 3	FM1/FM2/FM3/AM	1	0	1	1	South America	FM1/FM2/FM3/AM	1	1	0	0	USA 1	FM1/FM2	1	1	0	1	USA 2	FM	1	1	1	0	Middle east/Australia 1	FM1/FM2	1	1	1	1	Middle east/Australia 2	FM
		AREA3	AREA2	AREA1	AREA0	Area	Band																																																																																																	
		0	0	0	0	Europe 1	FM1/FM2/MW/LW																																																																																																	
		0	0	0	1	Europe 2	MW/LW																																																																																																	
		0	0	1	0	Europe 3	FM/AM																																																																																																	
		0	0	1	1	South America	FM1/FM2/AM																																																																																																	
		0	1	0	0	USA 1	FM1/FM2/AM																																																																																																	
		0	1	0	1	USA 2	FM1/FM2/FM3/AM																																																																																																	
		0	1	1	0	Middle east/Australia 1	FM1/FM2/AM																																																																																																	
		0	1	1	1	Middle east/Australia 2	FM1/FM2/FM3/AM																																																																																																	
		1	0	0	0	Europe 1	FM1/FM2/FM3																																																																																																	
		1	0	0	1	Europe 3	FM																																																																																																	
		1	0	1	0	Europe 3	FM1/FM2/FM3/AM																																																																																																	
		1	0	1	1	South America	FM1/FM2/FM3/AM																																																																																																	
1	1	0	0	USA 1	FM1/FM2																																																																																																			
1	1	0	1	USA 2	FM																																																																																																			
1	1	1	0	Middle east/Australia 1	FM1/FM2																																																																																																			
1	1	1	1	Middle east/Australia 2	FM																																																																																																			
COLON	0	Clock colon display selection set to always on.																																																																																																						
	1	Clock colon display selection set to blink at a 1 Hz rate.																																																																																																						
CD SEL	0	No CD function																																																																																																						
	1	CD function enabled																																																																																																						
DF SEL		Double function key selection																																																																																																						
		<table border="1"> <thead> <tr> <th>DFSEL</th> <th>Mode</th> <th>M4/METAL</th> <th>M5/DOLBY</th> <th>M6/APSS</th> </tr> </thead> <tbody> <tr> <td rowspan="2">0</td> <td>RADIO</td> <td>M4</td> <td>M5</td> <td>M6</td> </tr> <tr> <td>TAPE</td> <td>METAL</td> <td>DOLBY</td> <td>APSS</td> </tr> <tr> <td rowspan="2">1</td> <td>RADIO</td> <td>M4</td> <td>M5</td> <td>M6</td> </tr> <tr> <td>TAPE</td> <td>—</td> <td>—</td> <td>—</td> </tr> </tbody> </table>	DFSEL	Mode	M4/METAL	M5/DOLBY	M6/APSS	0	RADIO	M4	M5	M6	TAPE	METAL	DOLBY	APSS	1	RADIO	M4	M5	M6	TAPE	—	—	—																																																																															
		DFSEL	Mode	M4/METAL	M5/DOLBY	M6/APSS																																																																																																		
		0	RADIO	M4	M5	M6																																																																																																		
TAPE	METAL		DOLBY	APSS																																																																																																				
1	RADIO	M4	M5	M6																																																																																																				
	TAPE	—	—	—																																																																																																				
AUTO500	0	The MAN UP/T UP and MAN DN/T DN key functions as the MAN UP/DN key																																																																																																						
	1	The MAN UP/T UP and MAN DN/T DN key functions as the T UP/DN key																																																																																																						
CLOCK	0	Clock function enabled (24-hour display in Europe, 12-hour display in other reception areas)																																																																																																						
	1	No clock																																																																																																						
IF0	0	Auto stop on SD only																																																																																																						
	1	Auto stop on SD and IF count																																																																																																						
PRIORITY	0	Clock display takes priority																																																																																																						
	1	Frequency, tape and CD displays take priority																																																																																																						
FADER	0	Fader function enabled																																																																																																						
	1	No fader function																																																																																																						
VR SEL	0	Electronic volume/tone control functions enabled																																																																																																						
	1	No electronic volume/tone control functions																																																																																																						
POWSEL	0	The power key turns the power on or off.																																																																																																						
	1	The HOLD pin turns the power on or off.																																																																																																						
LEDSEL	0	LEDs flash when /HOLD is low.																																																																																																						
	1	LEDs do not flash when /HOLD is low.																																																																																																						
POWAMP	0	The LC75371M input gain control data outputs +18 dB.																																																																																																						
	1	The LC75371M input gain control data outputs 0 dB.																																																																																																						

LC72323-XXXX

Ports

Pin	Name	I/O	Allocation	Active	Function	Handling when unused	
1	XIN	I	XIN	—	Connection for the 4.5 MHz crystal	—	
2	TEST2	I	TEST2	—	Connect to ground	—	
3	PG3	I	SK	H	High: "SK" display on, low: "SK" display off In bands other than the FM band, the SK display is always off regardless of whether this pin is high or low. An SK high search starts when the VF key is pressed. When an SD present state is detected, the circuit checks again after between 375 and 500 ms, and if the signal is high, it holds that frequency. After that, if a low level continues for 25 seconds, an auto retune operation starts. (sampling = 25 ms)	Connect directly to ground.	
4	PG2	I	DK	H	In VF mode and in either tape or CD mode, if a high level is input to this signal (if a high level is detected three times in a row at 25 ms intervals), the circuit switches to radio mode, and ARI broadcast reception becomes possible. Also, after a VF key on and an SK seek, DK is checked 2 s after an SK present state is recognized.	Connect directly to ground.	
5	PG1	I	/SD	L	Output signal that reports station reception during auto tuning.	Must be used.	
6	PG0	I	/ST	L	Low: "STEREO" display on, high: "STEREO" display off the STEREO display is turned off in bands other than the FM band regardless of the high or low state of this pin.	Connect directly to V _{DD} .	
7	PH3	O	BEEP	H	Monitors all keys and outputs a 50 ms 3 kHz pulse when any key is pressed. (A pull-up resistor is required.)*	Open	
8	PH2	O	BAND2	H	These pin outputs change according to the table when either the BAND or VF key is pressed. (A pull-up resistor is required.)	Open	
9	PH1	O	BAND1	H			
10	PH0	O	/POWER	L	Outputs a low level in power on mode, high in power off mode. (A pull-up resistor is required.)	Connect directly to ground.	
11	PF3	O	LOCAL	H	Outputs a low level in normal mode. Outputs a high level when the DX display is turned off in seek and scan modes.	Open	
12	PF2	O	STEREO	H	The output is inverted when the stereo key is pressed in the FM band.	Open	
13	PF1	I	/TAPE	L	Detects a tape input.	Connect directly to V _{DD} .	
14	PF0	I	TAPE RUN	—	The "▶" indicator lights when high and the "◀" indicator lights when low.	Connect directly to ground.	
15	PE3	O	DOLBY	H	High indicates that the Dolby indicator is on (only in tape mode) and a low indicates that the Dolby indicator is off.	Open	
16	PE2	O	METAL	H	High indicates that the metal indicator is on (only in tape mode) and a low indicates that the metal indicator is off.	Open	
17	PE1	O	APSS	H	High indicates that the "APSS" indicator is on (only in tape mode) and a low indicates that the "APSS" indicator is off.	Open	
18	PE0	O	LOUDNESS	H	High indicates that the loudness indicator is on and a low indicates that the loudness indicator is off.	Open	
19	PD3	O	/AMUTE	L	Audio mute output	Open	
20	PD2	O	LEDFL	H	The LEDs flash when /HOLD is low. (When LEDSEL is 0.)	Open	
21	PD1	O	DI/KS9	H	Connect to the LC75371M DI pin.	Diode matrix source output Open	
22	PD0	O	CLK/KS8	H	Connect to the LC75371M CLK pin.		
23	PC3	O	CE/KS7	H	Connect to the LC75371M CE pin.		
24	PC2	O	KS6	H			
25	PC1	O	KS5	H			
26 to 30	PC0 to PB0	O	KS4 to KS0	H	Key matrix source output	Open	
32 to 35	PA3 to PA0	I	K3 to K0	H	Key & diode matrix return input	Connect directly to ground.	
36 to 63	S28 to S1	O	S28 to S1	H	LCD segment output	Open	

Note: * See the item on double function key beep output.

Continued on next page.

LC72323-XXXX

Continued from preceding page.

Pin	Name	I/O	Allocation	Active	Function	Handling when unused
64	COM2	O	COM2	H	LCD common output	Open
65	COM1	O	COM1	H		
66	/INT	I	/TELIN	L	When this pin is set low, "TEL" is displayed and the /AMUTE pin is set low. When PRIORITY is 0, "TEL" is displayed for 5 seconds and then the display returns to the clock display.	Connect directly to V _{DD} .
67	/HOLD	I	/HOLD	L	Used for detecting the power on/off state. When /HOLD goes low • If the clock function is enabled: The clock count function operates without stopping the oscillator. • If the clock function is disabled: The oscillator is stopped and the chip goes to the power save mode.	—
68	/RES	I	/RES	L	Connect to V _{DD} .	—
69	ADI	I	ADI	—	Connect to the S METER pin. (max = 3.2 V)	Connect directly to ground.
70	HCTR	I	FMIF	—	Inputs the FM IF signal.	Connect directly to ground.
71	LCTR	I	AMIF	—	Inputs the AM IF signal.	Connect directly to ground.
72	/SNS	I	/SNS	L	Used for power supply detection.	Connect directly to V _{DD} .
73	V _{DD}	I	V _{DD}	—	Connect to +5 V.	Connect directly to V _{DD} .
74	FMIN	I	FM OSC	—	FM local oscillator input	Connect directly to ground.
75	AMIN	I	AM OSC	—	AM local oscillator input	Connect directly to ground.
76	V _{SS}	I	V _{SS}	—	Connect to ground.	—
77	EO1	O	EO1	—	Phase comparator output	Open
78	EO2	O	EO2	—	Phase comparator output	Open
79	TEST1	I	TEST1	—	Connect to ground.	Connect directly to ground.
80	XOUT	O	XOUT	—	Connection for the 4.5 MHz crystal	—

Display

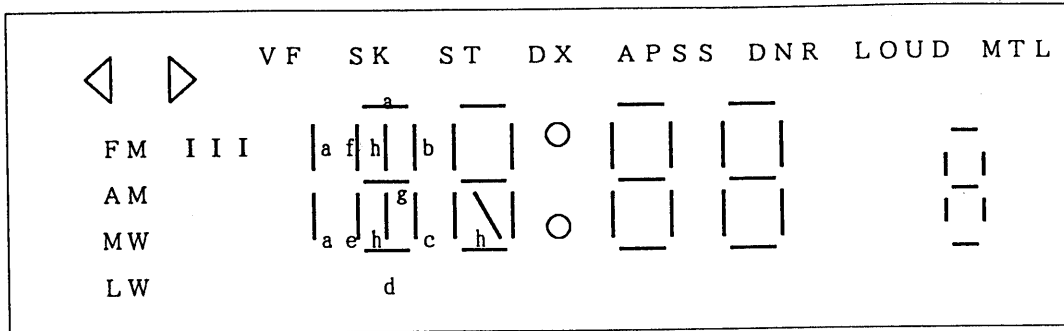

digit	1	2	3	4	5	6
	COM 1		COM 2			
S 1	<		>			
S 2	FM		AM			
S 3	MW		LW			
S 4	I		I I			
S 5	DX		AP S			
S 6	COLON(upper)		COLON(lower)			
S 7	S K		V F			
S 8	1a		S T			
S 9	2f		2b			
S 1 0	2e		2g			
S 1 1	2d		2c			
S 1 2	2a		2h			
S 1 3	3f		3b			
S 1 4	3e		3g			
S 1 5	3d		3c			
S 1 6	3a		3h			
S 1 7	4f		4b			
S 1 8	4e		4g			
S 1 9	4d		4c			
S 2 0	4a		D N R			
S 2 1	5f		5b			
S 2 2	5e		5g			
S 2 3	5d		5c			
S 2 4	5a		L O U D			
S 2 5	6f		6b			
S 2 6	6e		6g			
S 2 7	6d		6c			
S 2 8	6a		M T L			

Electronic Volume/Tone Controls Display Examples

FF 9

FADER FRONT

F 0

FADER CENTER

FR 9

FADER REAR

BL 9

BALANCE LEFT

B 0

BALANCE CENTER

BR 9

BALANCE RIGHT

TR - 7

TREBLE CUT

TR 0

TREBLE CENTER

TR 7

TREBLE BOOST

BA - 7

BASS CUT

BA 0

BASS CENTER

BA 7

BASS BOOST

U 0 3 3

VOLUME

U 0 0

VOLUME

TEL

TELEPHONE MUTE

FM I
1 0 7 . 9 5 6

FM RADIO

AM
1 7 2 0 5

AM RADIO

CD

CD MODE

FM II
1 2 : 0 0 4

CLOCK(12Hr)

MW
2 3 : 5 9 3

CLOCK(24Hr)

TAPE

TAPE MODE

Key Functions

1. Keys M1 to M6

- Radio mode

In radio mode these keys are used for writing and reading preset memory.

Pressing and then releasing one of the keys M1 to M6 within 1.5 seconds reads out the corresponding memory.

Holding the key down for over 1.5 seconds writes the currently displayed frequency to memory.

- Tape mode

In tape mode, the M4, M5 and M6 keys are used for tape control.

Diode matrix switching enables double function key type selection.

M4/Metal key

The port and the display are inverted each time this key is pressed.

Key	Display state		Output state
METAL	METAL	On	H
		Off	L

M5/Dolby key

The port and the display are inverted each time this key is pressed.

Key	Display state		Output state
DOLBY	DOLBY	On	H
		Off	L

M6/APSS key

The port and the display are inverted each time this key is pressed.

Key	Display state		Output state
APSS	APSS	On	H
		Off	L

- VF mode

In VF mode, the M1 to M6 keys have their radio mode functions during tape and CD operation.

2. MAN UP/T UP, MAN DN/T DN

- When the AUTO500 diode matrix setting is 0

The frequency is incremented or decremented by one step each time the manual tuning key is pressed. The frequency is advanced at about 70 ms per step when the key is held down for over 500 ms. The system pauses for about 500 ms when crossing from band edge to band edge.

- When the AUTO500 diode matrix setting is 1

The system switches to manual tuning mode if the key is pressed and held down for less than 500 ms, and to seek mode if pressed and held down for longer than 500 ms.

In VF mode, these keys function as the seek up key and the seek down key.

3. Seek up and seek down

These operations automatically search for a station and hold that station when found. During a seek, the system will switch to scan mode if a scan key is pressed. Therefore, if the scan up key is pressed during a seek down operation, a scan in the up direction is started. Similarly, if the seek down (or up) key is pressed during a seek up (or down) operation, a seek down (or up) operation starts. Search mode is cleared if the same key is pressed twice in a row. The search pauses for 500 ms when switching from one band edge to another. The search speed is 50 ms per step in FM mode, and 70 ms per step in AM mode.

4. Scan up

In this mode, the system searches for a station. When a station is found it stops and holds that station for 5 seconds (with AMUTE high) and flashes the frequency display. If the key is pressed once again during that interval, the system stops and holds that frequency. If no event occurs during that 5 second interval, the system resumes the search.

If the seek down key is pressed during a scan, a seek in the down direction starts. Scan mode is cleared by pressing the scan up key twice. The scan pauses for 500 ms when switching from one band edge to another. The search speed is 50 ms per step in FM mode, and 70 ms per step in AM mode.

5. Band

- Pressing this key switches the band.

The table lists the band switching operation under each reception area.

Band switching with the band	Reception area
	Europe 1
	USA 2, Middle east/Australia 2, Europe 3, South America
	Europe 1
	USA 1, Middle east/Australia 1, South America
	USA 1, Middle east/Australia 1
	Europe 3
	Europe 2

- See the description for the AREA0 to AREA3 diode switch settings for details on the reception areas.

6. Local

Pressing this key in radio mode turns off the DX display. If a seek or scan key is pressed in this state, the local pin goes high and a local search is performed. When the seek or scan is cleared, the local pin goes low. (See section “LOC pin control”)

Key	Display state	Normal output state	Search mode output state
LOCAL	DX	On	L
		Off	H

Note: The initial state is DX mode.

7. Loudness

When this key is pressed, the “LOUD” indicator lights and the LC75371M LOUD DATA goes to the on state. If this key is pressed while the LOUD indicator is lit, the indicator goes out and the LC75371M LOUD DATA goes to the off state.

8. Power (Can be used when DIMRX POWSEL = 0.)

This key is used when controlling the power by the tact key in the key matrix.

Pressing this key inverts the POWER pin.

9. Stereo

Pressing this key inverts the STEREO pin if the system is in radio mode (including VF mode) and in the FM band. The STEREO pin is high in the initial state.

10. Mute

Pressing this key sets the $\overline{\text{AMUTE}}$ pin low and the LC75371M volume setting is set to $-\infty$. Furthermore, the current volume setting is displayed flashing. This mode can be cleared by pressing this key once again, or by pressing any other key.

11. PS/AMEM

The system starts a preset scan operation if this key is pressed and held down for less than 2 seconds, and starts an auto store memory operation if held down for over 2 seconds.

• PS operation

When this key is pressed, the channel number advances sequentially starting with the next channel number after the currently displayed channel number. If no channel number is displayed, the channel number is started at 1. If there is a station present at this time, AMUTE (which is high) is cleared for a 5 second interval. The reception state is set to the DX state regardless of the LOC/DX setting and the channel number blinks at a 1 Hz rate during PS operation. This operation is cleared by pressing the PS/AMEM key twice or by pressing one of the following keys: MAN UP/T UP, DISP, SEEKUP, SEEK DOWN, SCANUP, M1 to M6, VF, BAND, or CD.

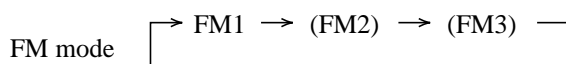

• Auto memory operation (AMEM key)

The system enters auto memory operation when this key is pressed and held down for over 2 seconds. For the FM band, the system starts a search from the low edge of the band, and stores the stations found starting in M1 in order of station strength. The search stops after one pass over the band and if all the memory locations were not filled, the remaining memory locations are left unchanged. The station in M1 is recalled when the auto memory operation terminates.

For the AM band, first the LOCAL pin is set high and a search is started from the low edge of the band. Stations are stored in order found starting in M1, without regard for the strength of the stations. If one pass over the band is made and not all the memory locations are filled, the local pin is set low and the search is repeated. At the point that stations are stored through M6 or two passes over the band complete, the auto memory operation terminates and the station in M1 is recalled.

— For the FM band:

[When FM1, FM2 and FM3 are selected]

- : When started from the FM1 band, from FM1's M1 to FM1's M6 Six stations
- : When started from the FM2 band, from FM2's M1 to FM2's M6 Six stations
- : When started from the FM3 band, from FM3's M1 to FM3's M6 Six stations

[When FM1 and FM2 are selected]

- : When started from the FM1 band, from FM1's M1 to FM1's M6 Six stations
- : When started from the FM2 band, from FM2's M1 to FM2's M6 Six stations

[When only FM1 is selected]

- : When started from the FM1 band, from FM1's M1 to FM1's M6 Six stations

For all bands, the channel number | | will flash at a 1 Hz rate during the auto memory operation.

This operation is cleared by pressing the PS/AMEM key twice or by pressing one of the following keys: MAN UP/T UP, DISP, SEEKUP, SEEK DOWN, SCANUP, M1 to M6, VF, BAND, or CD.

12. CD

When this key is pressed, the CD display is turned on and the LC75371M input switching control data is changed to specify CD mode. If this key is pressed again, CD mode is cleared, the CD display is turned off and the LC75371M input switching control data is changed to the last mode.

If this key is pressed when HOLD is high, CD mode is entered with highest priority. After CD mode is turned on, CD mode is not cleared by HOLD going from high to low to high, or by the power going from on to off to back on again.

13. DISP

This key is used to change the display for each mode when the clock function is enabled (when the diode matrix CLOCK setting is 0).

Mode	DIMRX "PRIORITY" = 0 (Clock display takes priority)	DIMRX "PRIORITY" = 1
RADIO mode	<p>Press DISP</p> <p>Clock display → Frequency display → Clock display</p> <p>Press DISP after 5 seconds</p> <p>* RADIO key → Frequency display → Clock display</p> <p>Five seconds after operation is complete</p> <p>* RADIO key</p> <p>MAN UP/T UP MAN DN/T DN STEREO SEEK UP SEEK DN SCAN UP PS/AMEM M1 to M16 VF BAND LOCAL</p>	<p>Frequency display</p> <p>↓</p> <p>Press DISP</p> <p>Clock display</p> <p>↓</p> <p>DISP after 5 seconds</p> <p>Frequency display</p> <p>However, note that if a radio key is pressed during clock display, the LC72323-XXXX returns to frequency display even if the 5 seconds have not elapsed.</p>
TAPE mode	<p>Press DISP</p> <p>Clock display → Tape display → Clock display</p> <p>DISP after 5 seconds</p> <p>• During tape input, tape display is performed for 5 seconds.</p>	<p>Frequency display</p> <p>↓</p> <p>Press DISP</p> <p>Clock display</p> <p>↓</p> <p>DISP after 5 seconds</p> <p>Frequency display</p>
CD mode	<p>Press DISP</p> <p>Clock display → CD display → Clock display</p> <p>DISP after 5 seconds</p> <p>• During CD input, CD display is performed for 5 seconds.</p>	<p>CD display</p> <p>↓</p> <p>Press DISP</p> <p>Clock display</p> <p>↓</p> <p>DISP after 5 seconds</p> <p>CD display</p>
VF mode	<p>During tape or CD input</p> <p>SK search</p> <p>SK = "H" DK = "L"</p> <p>Frequency display → Tape or CD display → Clock display</p> <p>After 5 seconds</p> <p>DK on</p> <p>After 5 seconds</p>	<p>SK search</p> <p>Frequency display</p> <p>↑</p> <p>DK = "H"</p> <p>↓</p> <p>SK = "L" DK = "L"</p> <p>Tape or CD display</p>

• DISP + MAN UP/T UP

When the clock is displayed, pressing these keys at the same time adjusts the minutes setting. Each time the keys are pressed the setting is incremented by 1 minute, and if they are held down together for over 500 ms, the minutes setting slews at 8 minutes per second. The seconds setting is reset to 0 by these operations. There is no carry out of the minutes into the hours.

LC72323-XXXX

- DISP + MAN DN/T DN

When the clock is displayed, pressing these keys at the same time adjusts the hours setting. Each time the keys are pressed the setting is incremented by 1 hour, and if they are held down together for over 500 ms, the minutes setting slews at 4 hours per second. This operation does not affect the minutes or seconds setting.

14. VF

When this key is pressed, the radio is turned on in FM band (the last FM band) VF mode, whatever mode the radio was set to. The VF display is turned on and the BAND1 and BAND2 outputs are set high. Then, 375 ms later (500 ms from the AM band) an SD is checked and after another 375 to 500 ms an SK is checked. If that signal was high, that frequency is held. If that signal was low, an SK station search is performed automatically. When SK goes high that frequency is held.

The SK display is turned on if SK is high in the FM band in the European reception area, regardless of the state of VF mode.

Key	Display state		Output state	
			BAND1	BAND2
VF	VF	On	H	H
		Off	*	*

Note: * State from the previous band

The table below lists the operations that occur when the VF and SEEK keys are pressed according to the VF mode and SK signal states.

VF (VF mode)	SK	When the VF key is pressed	When the SEEK key is pressed	When, during a seek, the seek key for the same direction is pressed	When the VF key is pressed during a seek.
Off	L	VF mode is turned on and an SK station search is started.	A normal station search is started.	The LC72323-XXXX stops at the frequency where pressed.	VF mode is turned on and an SK station search is started.
Off	H	VF mode is turned on.	A normal station search is started.	The LC72323-XXXX stops at the frequency where pressed.	VF mode is turned on and an SK station search is started.
On	L/H	VF mode is turned off.	An SK station search is started.	The seek continues.	VF mode is turned off and the LC72323-XXXX returns to the state prior to entering VF mode.

- The table below lists the operations that occur depending on SK and DK when VF is pressed when the system is in tape or CD mode (with VF mode off).

	SK	DK	Operation when VF mode is switched from off to on by pressing the VF key in tape or CD mode	Mode
①	L	L	The frequency is displayed and an up direction SK signal seek is started. If a high level SKIN is found, the display switches to CD or tape mode. If DK is high, operation continues with item ③ below.	TAPE mode CD mode
②	H	L	The tape or CD display remains unchanged. If DK is high, operation continues with item ③ below. If SK goes low for 25 seconds, a retune operation is started.	TAPE mode CD mode
③	H	H	The frequency is displayed and an ARI broadcast is started.	VF mode

- On a power on (HOLD: low → high), SK is checked for 25 seconds, and a retune operation is started if low.
- VF mode is cleared when the VF or BAND key is pressed. However, the BAND key is ignored if TAPE is low or CD is on.

The figure shows the state transition diagram for VF mode.

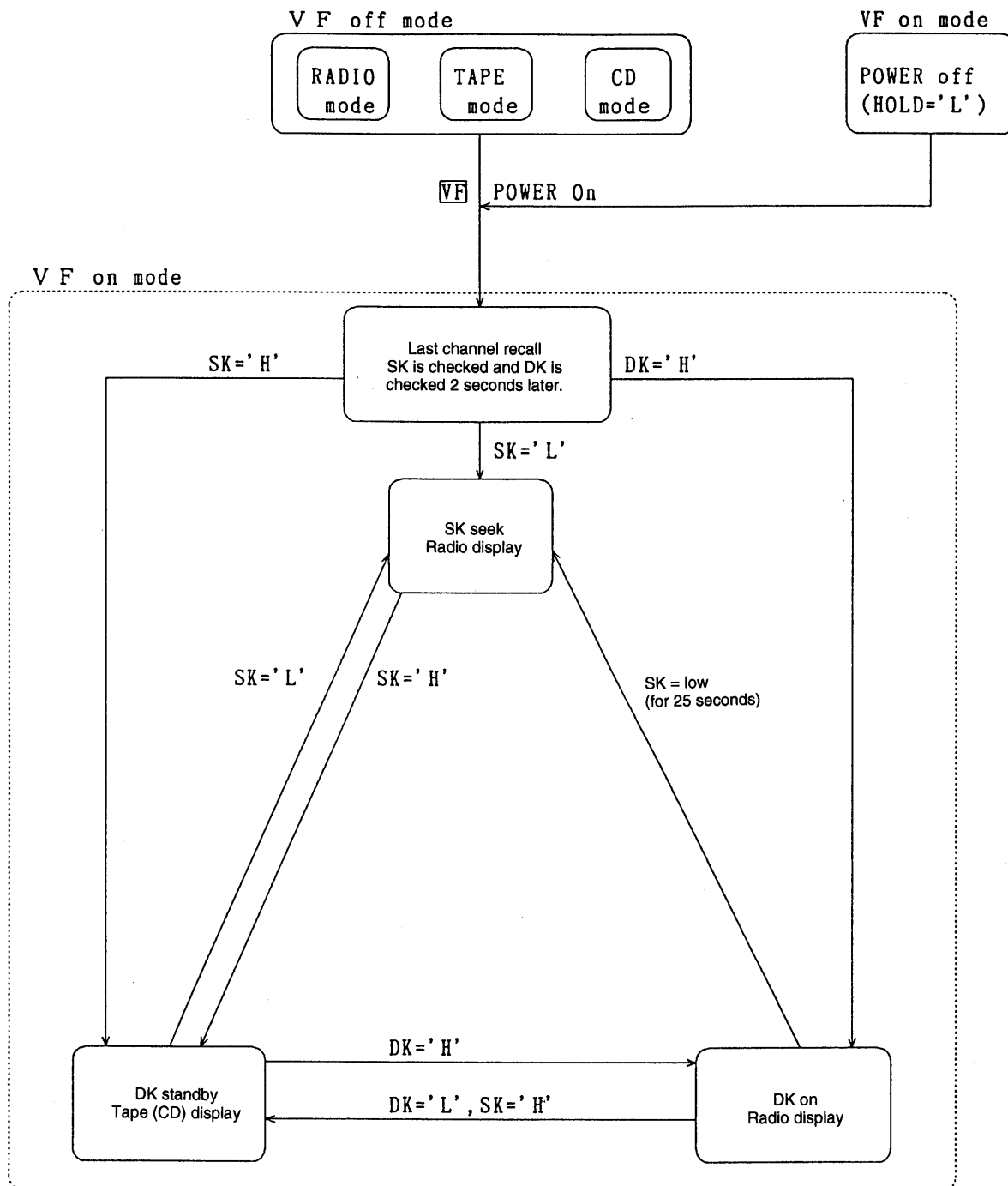

15. MODE

Pressing this key steps through the volume/tone controls starting with the bass control, which is the next control. The system automatically returns to the volume control position 5 seconds after this key is released, and the 7 segment character display returns to frequency, tape, or CD display. However, if V-UP or V-DOWN is pressed within 5 seconds the system returns to the volume control position 5 seconds after that key is released, and the 7 segment character display returns to frequency, tape, or CD display.



16. V UP, V DOWN

When one of these keys is pressed, the setting is increased or decreased in 1 dB steps.

When DK is on, the volume is increased up to -30 dB. If the volume is over -30 dB, it remains unchanged.

In the tuner, tape, or CD display states, setting always starts with the volume setting when these keys are pressed.

In volume mode

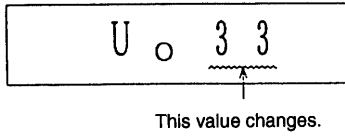

Control data (dB)	Display	Control data (dB)	Display	Control data (dB)	Display	Control data (dB)	Display
-∞	0	-59	21	-38	42	-17	63
-79	1	-58	22	-37	43	-16	64
-78	2	-57	23	-36	44	-15	65
-77	3	-56	24	-35	45	-14	66
-76	4	-55	25	-34	46	-13	67
-75	5	-54	26	-33	47	-12	68
-74	6	-53	27	-32	48	-11	69
-73	7	-52	28	-31	49	-10	70
-72	8	-51	29	-30	50	-9	71
-71	9	-50	30	-29	51	-8	72
-70	10	-49	31	-28	52	-7	73
-69	11	-48	32	-27	53	-6	74
-68	12	-47	33	-26	54	-5	75
-67	13	-46	34	-25	55	-4	76
-66	14	-45	35	-24	56	-3	77
-65	15	-44	36	-23	57	-2	78
-64	16	-43	37	-22	58	-1	79
-63	17	-42	38	-21	59	0	80
-62	18	-41	39	-20	60		
-61	19	-40	40	-19	61		
-60	20	-39	41	-18	62		

- When one of these keys is held down for over 500 ms, the setting slews at 150 ms per step.
- The initial value is -50 dB.

In bass/treble mode

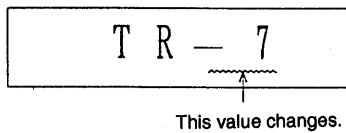
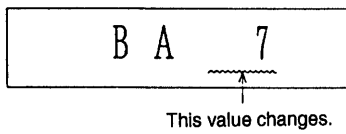

Control data (∞)	Display	Control data (∞)	Display
Step 18	7	Step 10	-1
Step 17	6	Step 9	-2
Step 16	5	Step 8	-3
Step 15	4	Step 7	-4
Step 14	3	Step 6	-5
Step 13	2	Step 5	-6
Step 12	1	Step 4	-7
Step 11	0		

- When one of these keys is held down for over 500 ms, the setting slews at 150 ms per step.
- The initial value is step 11.

In balance mode

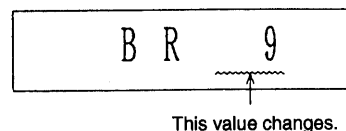
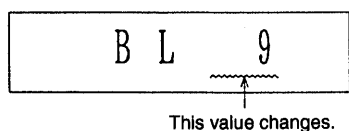

Display	0	1	2	3	4	5	6	7	8	9	10	11	12
Volume difference (dB)	0	-2	-4	-6	-8	-10	-12	-14	-16, -18	-20, -24	-34, -44	-64	-∞

- When one of these keys is held down for over 500 ms, the setting slews at 150 ms per step.
- The initial value is 0 dB.

In fader mode

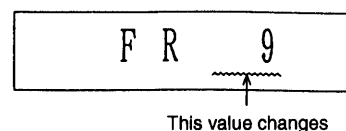
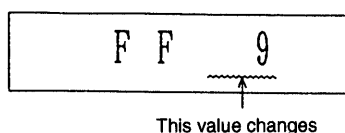

Display	0	1	2	3	4	5	6	7	8	9	10	11	12
Volume difference (dB)	0	-2	-4	-6	-8	-10	-12	-14	-16, -18	-20, -24	-34, -44	-64	-∞

- When one of these keys is held down for over 500 ms, the setting slews at 150 ms per step.
- The initial value is 0 dB.

Power Supply Connection

1. When the power key is used (when the diode matrix POWSEL setting is 0)

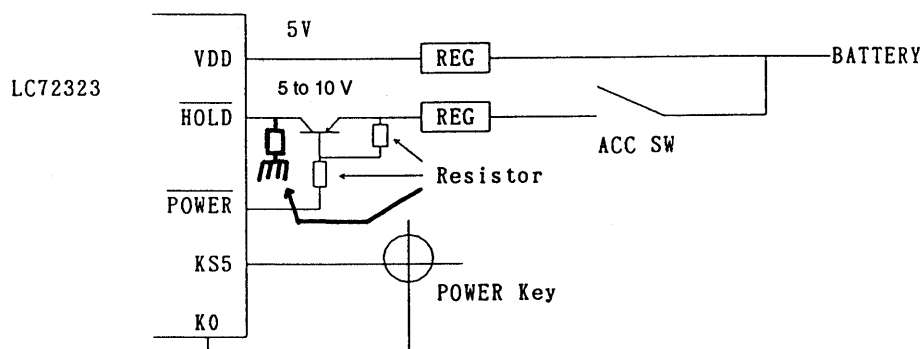

2. When an external power switch is used (when the diode matrix POWSEL setting is 0 or 1)

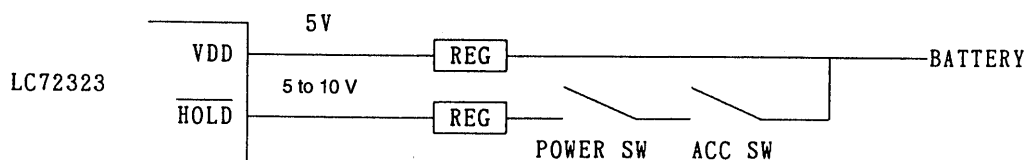

LC75371M Control

1. Input switching control

Each time the mode changes, the input switching control data for the LC75371M changes as listed in the table.

Mode	LC75371M state		
	D0	D1	R/L input port
RADIO	0	0	L1 (R1)
TAPE	1	0	L2 (R2)
CD	0	1	L3 (R3)

2. Transfer data output timing

- When $\overline{\text{AMUTE}}$ turns on and off

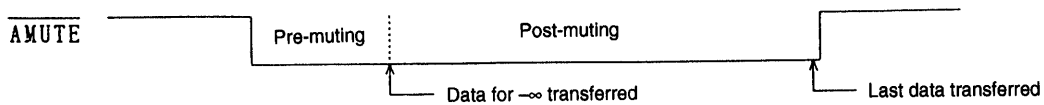

Note: When $\overline{\text{HOLD}}$ goes from low to high $-\infty$ data is transferred twice at an interval of 125 ms during the pre-muting period.

- When the V UP, V DOWN, or MUTE key is on
Data is transferred when the key is pressed.
- When the power goes from off to on

If the power is turned off with the volume at a value of -16 dB or higher, the volume is first set to -50 dB.

Timing

1. T UP/DN, SEEK, SCAN

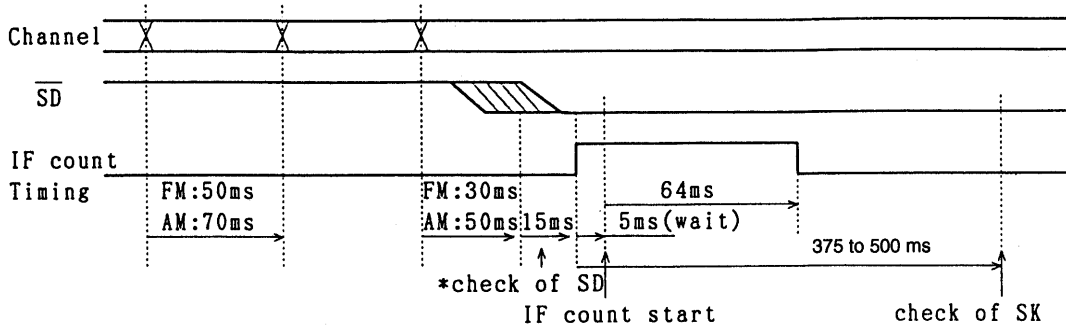

Note: 1. IF count tolerance

FM	10.7 MHz \pm 10 kHz
MW	450 kHz \pm 3 kHz
LW	450 kHz \pm 0.6 kHz

2. SD is checked for 10 ms if IF counting is enabled, and for 15 ms is IF counting is disabled.

2. Manual up and down (for both AM and FM modes)

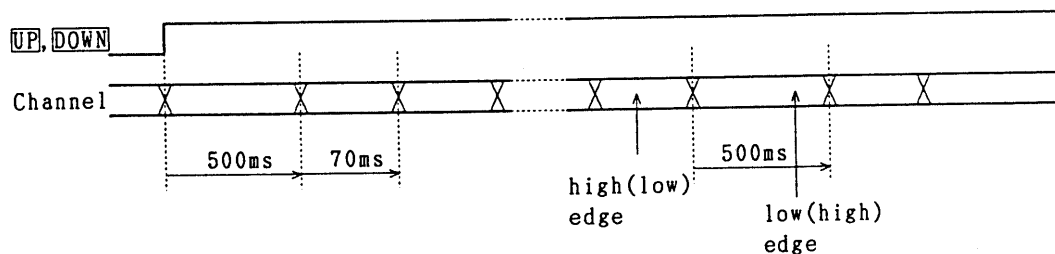

3. LOC pin control

Seek, scan, AMEM, VF and auto retune operations when the DX display is off

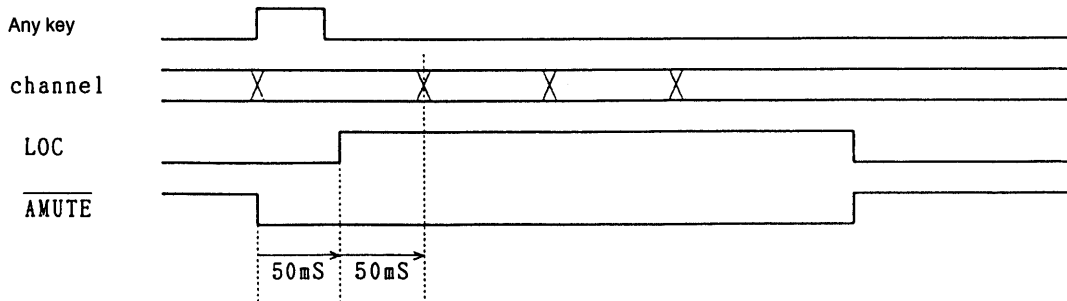

4. SK check timing when VF mode is switched from off to on

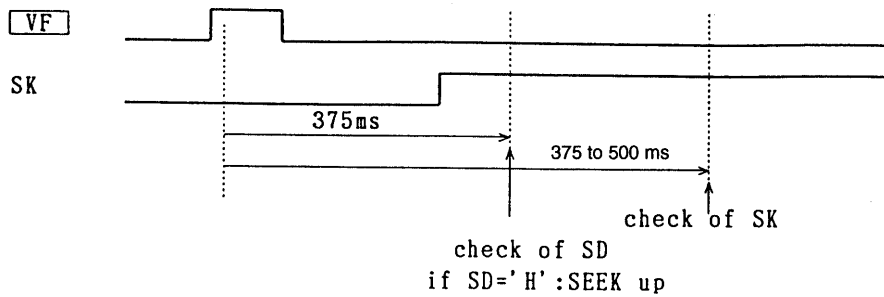

5. LED flashing

The LEDFL port operates as shown below when HOLD is low if the diode matrix LEDSEL setting is 0. (Backup mode is not entered when clock operation is enabled.)

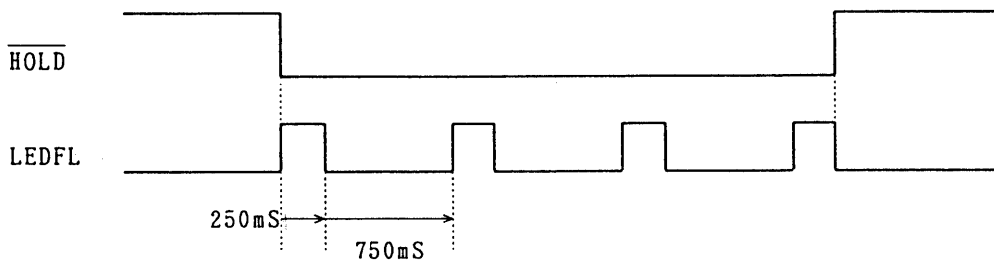

6. Audio mute (AMUTE)

- ① Key chattering rejection time (40 ms)
- ② Audio mute lead time and beep output (50 ms)
- ③ PLL data and display change processing (30 to 50 ms)
- ④ Audio mute trailing time

- BAND and M1 to M6 keys, and a VF on to off transition

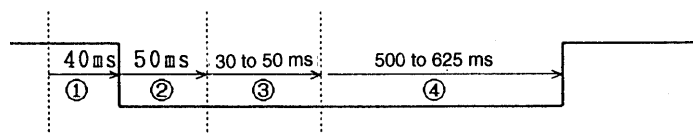

LC72323-XXXX

- VF off to on (except when $\overline{\text{TAPE}}$ and $\overline{\text{CDIN}}$ are low and CD mode is on with no DK signal)

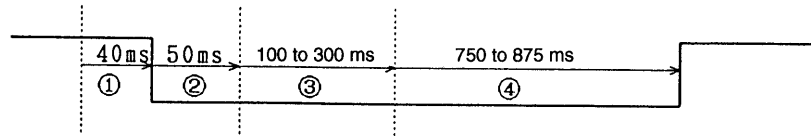

- Note: 1. Period ③ includes an SK check.
 2. AMUTE is not output in tape or CD mode (with DK low).

- UP, DOWN

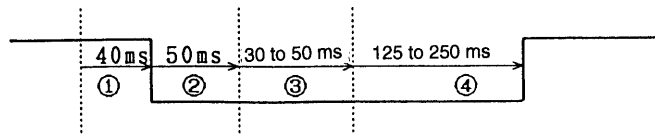

Note: Period ④ becomes 500 to 625 ms for a band edge to band edge operation.

- PS (preset scan)

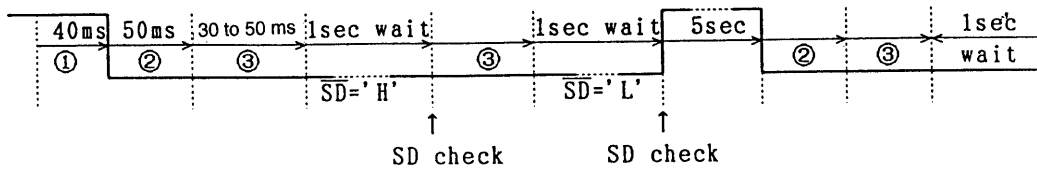

- AMEM, T UP/DN, SEEK, SCAN

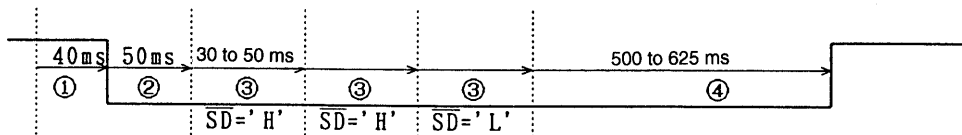

- VF auto retune

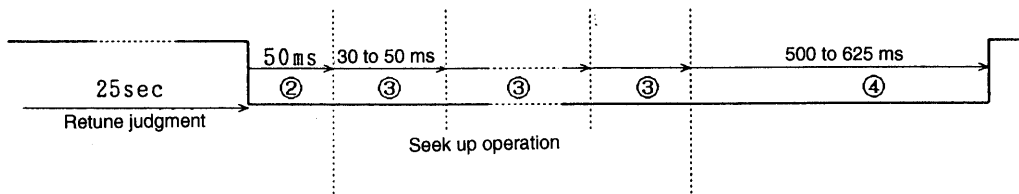

7. VF off to on timing (When a tape or CD is loaded)

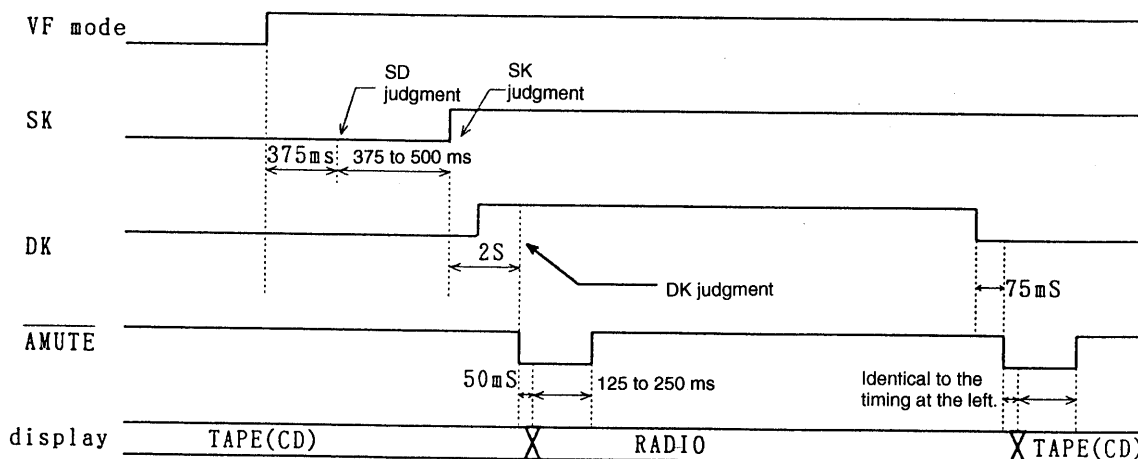

8. Allowed timing for the scan direction display by DIR

In FM radio mode or VF mode, the “▶” and “◀” displays are controlled as follows by SK controlled SK display, ST controlled ST display and TAPERUN.

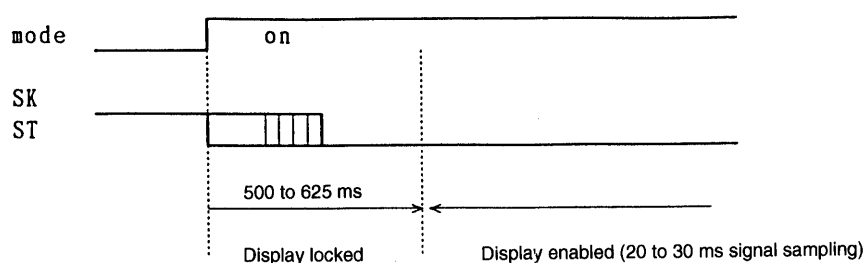

9. Beep output

For double function keys, i.e., M1 to M6, UP/T-UP, DOWN/T-DOWN, V-UP, V-DOWN and PS/AMEM, a beep tone is output once (within 0.5, 1.5 or 2.0 seconds) or twice (over 0.5, 1.5 or 2.0 seconds) so that the user will know which key has been pressed.

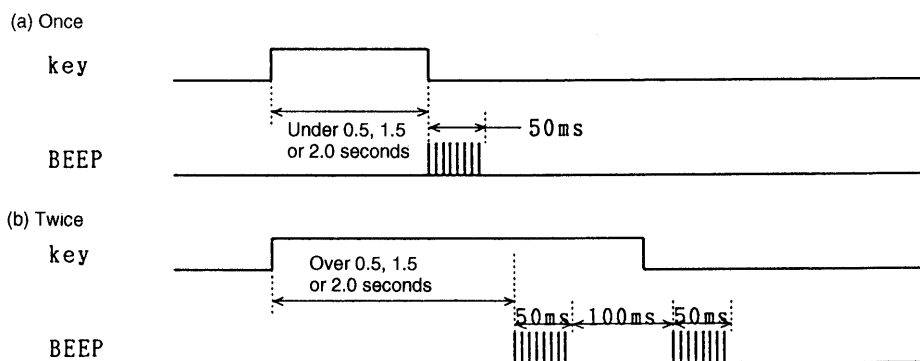

10. Hold mode

When the clock function is enabled, if the $\overline{\text{HOLD}}$ pin goes from high to low input to the FMIN, AMIN and HCTR pins will be disabled, and the system will go to a state where only the clock operates. This is called hold mode. When the $\overline{\text{HOLD}}$ pin goes from low to high, hold mode is cleared and the system returns to normal mode.

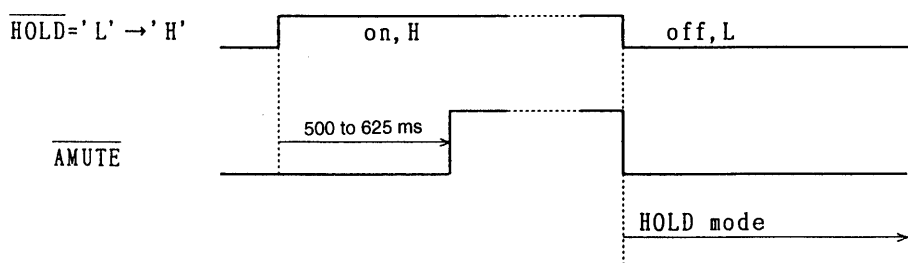

11. Backup mode

When the clock function is disabled, if the $\overline{\text{HOLD}}$ pin goes from high to low input to the FMIN, AMIN and HCTR pins will be disabled, the 4.5 MHz crystal oscillator will be stopped and the system will go to a power saving mode. This is called backup mode.

When the $\overline{\text{HOLD}}$ pin goes from low to high, hold mode is cleared and the system returns to normal mode 75 ms* later.

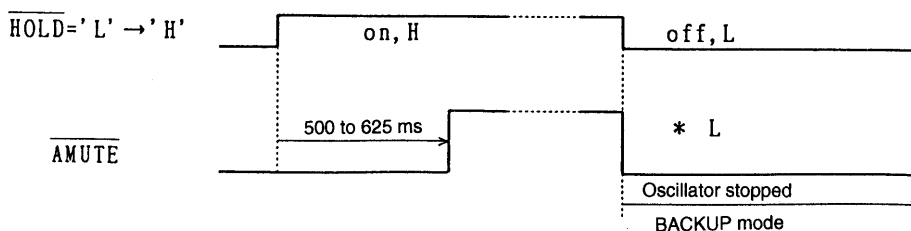

Note: All output ports go to the high-impedance state during this period.

Initial States

RADIO mode	TAPE mode	POWER on, HOLD = 'H'
<ul style="list-style-type: none"> • BandFM1 (low band edge) • MO/STstereo • VFoff • DXLOCAL off 	<ul style="list-style-type: none"> • NR Boff • APSoff • MTLoff 	<ul style="list-style-type: none"> • Volume setting-50 dB • CD off • LOUDoff • MUTE off

Tracking Point Frequency

Area	Band	M1	M2	M3	M4	M5	M6	Last channel
Europe	FM	87.5	90.0	89.0	106.0	108.0	87.5	87.5
	MW	531	603	999	1404	1602	531	531
	LW	153	160	200	260	281	153	153
USA	FM	87.9	90.1	98.1	106.1	107.9	87.9	87.9
	AM	530	600	1000	1400	1710	530	530
Middle east/ Australia	FM	87.9	90.0	98.0	106.0	107.9	87.9	87.9
	AM	531	603	999	1404	1602	531	531
South America	FM	87.5	90.0	98.0	160.0	108.0	87.5	87.5
	AM	520	600	1000	1400	1620	520	520

Note: The lower band edge is loaded for FM2, FM3 and MW2.

Application Circuit

1. When the POWER key is a touch switch
Diode matrix POWSEL setting is 0.

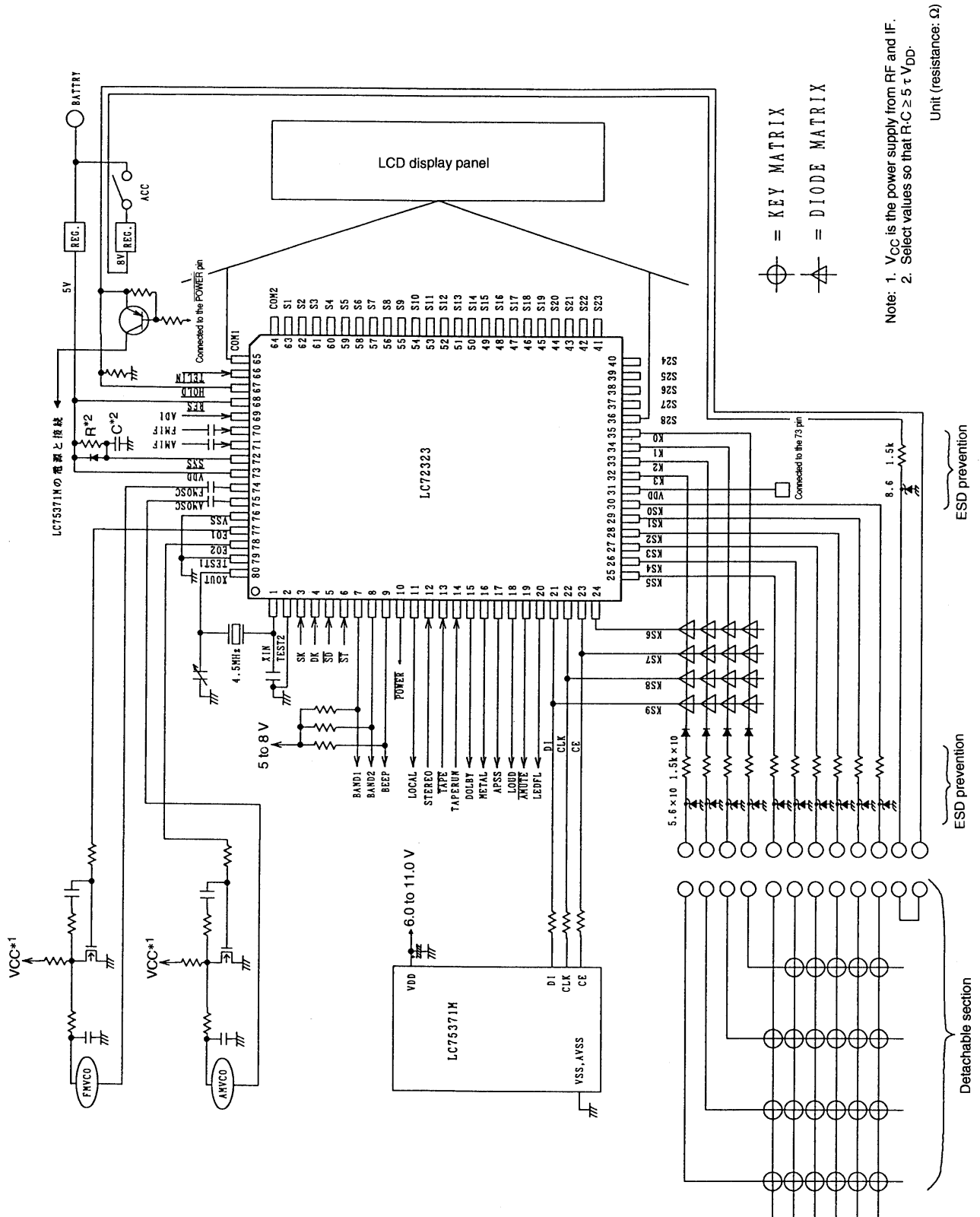

LC72323-XXXX

- When the POWER key is a mechanical switch
Diode matrix POWSEL setting is 1.

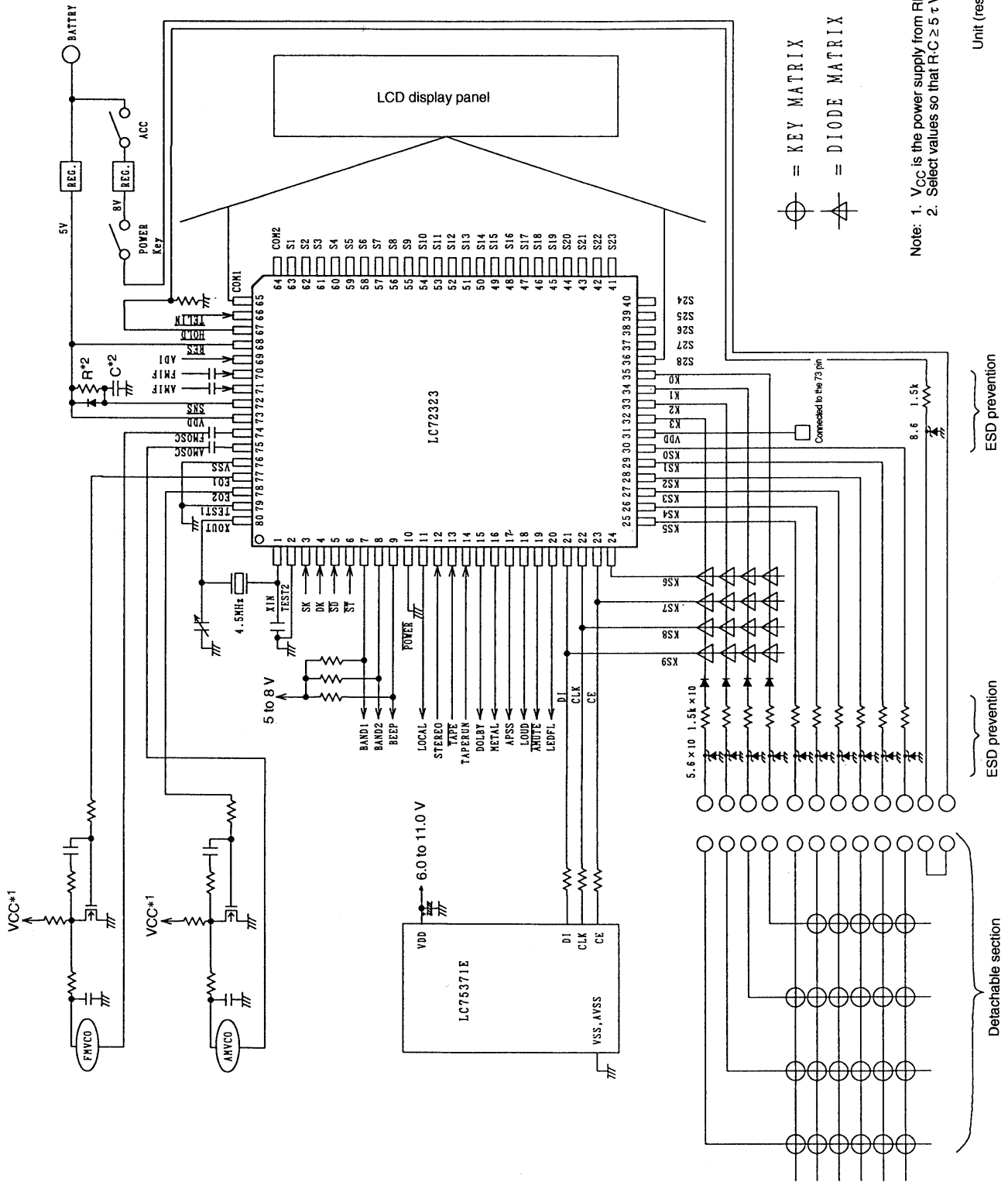

- No products described or contained herein are intended for use in surgical implants, life-support systems, aerospace equipment, nuclear power control systems, vehicles, disaster/crime-prevention equipment and the like, the failure of which may directly or indirectly cause injury, death or property loss.
- Anyone purchasing any products described or contained herein for an above-mentioned use shall:
 - ① Accept full responsibility and indemnify and defend SANYO ELECTRIC CO., LTD., its affiliates, subsidiaries and distributors and all their officers and employees, jointly and severally, against any and all claims and litigation and all damages, cost and expenses associated with such use:
 - ② Not impose any responsibility for any fault or negligence which may be cited in any such claim or litigation on SANYO ELECTRIC CO., LTD., its affiliates, subsidiaries and distributors or any of their officers and employees jointly or severally.
- Information (including circuit diagrams and circuit parameters) herein is for example only; it is not guaranteed for volume production. SANYO believes information herein is accurate and reliable, but no guarantees are made or implied regarding its use or any infringements of intellectual property rights or other rights of third parties.

This catalog provides information as of January, 1997. Specifications and information herein are subject to change without notice.