

DESCRIPTION

The LX5510 is a power amplifier optimized for WLAN applications in the 2.4-2.5 GHz frequency range. The PA is implemented as a two-stage monolithic microwave integrated circuit (MMIC) with active bias and input/output pre-matching.

The device is manufactured with an InGaP/GaAs Heterojunction Bipolar Transistor (HBT) IC process (MOCVD). With single low voltage supply of 3.3V 20 dB power gain between 2.4-2.5GHz, at a low quiescent current of 65mA.

For +19dBm OFDM output power (64QAM, 54Mbps), the PA provides a low EVM (Error-Vector Magnitude) of 3.0%, and consumes 125 mA total DC current with the nominal 3.3V bias. With increased bias of 5 V EVM is ~ 4% at 23 dBm.

The LX5510 is available in a 16-pin 3mmx3mm micro-lead quad package (MLPQ). The compact footprint, low profile, and excellent thermal capability of the MLPQ package makes the LX5510 an ideal solution for medium-gain power amplifier requirements for IEEE 802.11b/g applications

IMPORTANT: For the most current data, consult MICROSEMI's website: <http://www.microsemi.com>

KEY FEATURES

- Advanced InGaP HBT
- 2.4 – 2.5GHz Operation
- Single-Polarity 3.3V Supply
- Low Quiescent Current I_q ~65mA
- Power Gain ~20dB @ 2.45GHz and P_{out} = 19dBm
- Total Current 125mA for P_{out} = 19dBm @ 2.45GHz OFDM
- EVM ~ 3.0% for 64QAM / 54Mbps and P_{out} = 19dBm
- Small Footprint (3 x 3 mm²)
- Low Profile (0.9mm)

APPLICATIONS

- IEEE 802.11b/g

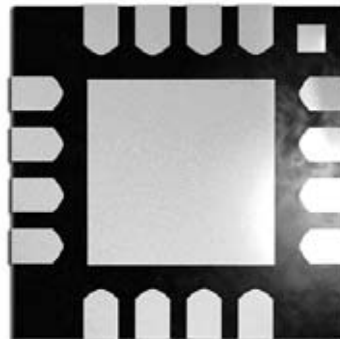
PRODUCT HIGHLIGHT

PACKAGE ORDER INFO

T _J (°C)	LQ	Plastic MLPQ 16 pin
0 to 70		LX5510CLQ

Note: Available in Tape & Reel.
Append the letter "T" to the part number.
(i.e. LX5510CLQT)

ABSOLUTE MAXIMUM RATINGS

DC Supply Voltage, RF off	6V
Collector Current	400mA
Total Power Dissipation.....	2W
RF Input Power	15dBm
Operation Ambient Temperature	-40°C to +85°C
Storage Temperature.....	-60°C to +150°C

Note: Exceeding these ratings could cause damage to the device. All voltages are with respect to Ground. Currents are positive into, negative out of specified terminal.
 x denotes respective pin designator 1, 2, or 3

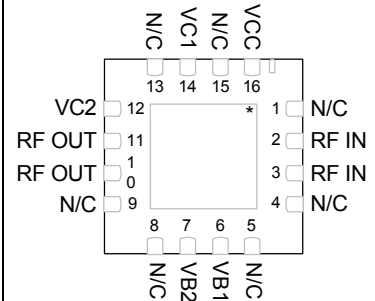
PACKAGE PIN OUT

* Pad is Ground

LQ PACKAGE
(Bottom View)

N/C = No connect

THERMAL DATA

LQ Plastic MLPQ 16-Pin

THERMAL RESISTANCE-JUNCTION TO CASE, θ_{JC}	10°C/W
THERMAL RESISTANCE-JUNCTION TO AMBIENT, θ_{JA}	50°C/W

FUNCTIONAL PIN DESCRIPTION

Name	Description
RF IN	RF input. This pin is DC-shorted to GND but AC-coupled to the transistor base of the first stage.
VB1	Bias current control voltage for the first stage.
VB2	Bias current control voltage for the second stage. The VB2 pin can be connected with the first stage control voltage (VB1) into a single reference voltage (referred to as Vref) through an external resistor bridge.
VCC	Supply voltage for the bias reference and control circuits. This pin can be combined with both VC1 and VC2 pins, resulting in a single supply voltage (referred to as Vc).
RF OUT	RF output.
VC1	Power supply for first stage amplifier. The VC1 feedline should be terminated with a 3.3 pF bypass capacitor, followed by a 8.2 nH blocking inductor at the supply side.
VC2	Power supply for second stage amplifier. The VC2 feedline should be driven with a 8.2 nH AC blocking inductor and 1 uF bypass capacitor.
GND	The center metal base of the MLP package provides both DC and RF ground as well as heat sink for the power amplifier.

ELECTRICAL CHARACTERISTICS

Unless otherwise specified, the following specifications apply over the operating ambient temperature $0^{\circ}\text{C} \leq T_A \leq 70^{\circ}\text{C}$ except where otherwise noted and the following test conditions: $V_C = 3.3\text{V}$, $V_{\text{ref}} = 2.85\text{V}$, $I_{\text{cq}} = 65\text{mA}$, $T_A = 25^{\circ}\text{C}$

Parameter	Symbol	Test Conditions	LX5510			Units
			Min	Typ	Max	
SECTION HEADER						
Frequency Range	f		2.4		2.5	GHz
Power Gain at Pout = 19dBm	Gp			20		dB
EVM at Pout = 19dBm		64GQAM / 54Mbps		3.0		%
Total Current at Pout = 19dBm	Ic_total			125		mA
Quiescent Current	Icq			65		mA
Bias Control Reference Current	Iref	For Icq = 65mA		1.2		mA
Small-Signal Gain	S21			20		dB
Gain Flatness	ΔS_{21}	Over 100MHz		1		dB
Gain Variation Over Temperature	ΔS_{21}	0°C to +70°C		1		dB
Input Return Loss	S11			10		dB
Output Return Loss	S22			10		dB
Reverse Isolation	S12			-40		dB
Second Harmonic		Pout = 19dBm		-55		dBc
Third Harmonic		Pout = 19dbm		-55		dBc
Total Current at Pout=23dBm		11 Mbps CCK		180		mA
2 nd side lobe at 23 dBm		11 Mbps CCK		-52		dBc
Ramp-On Time	t _{ON}	10 ~ 90%			100	ns

Note: All measured data was obtained on a 10 mil GETEK evaluation board without heat sink.

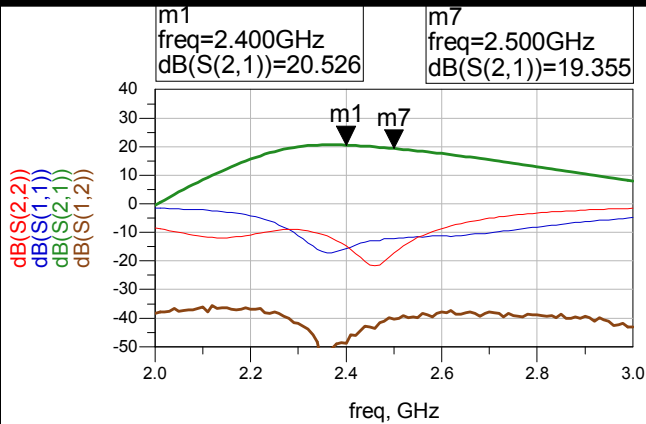
3.3V S PARAMETER DATA

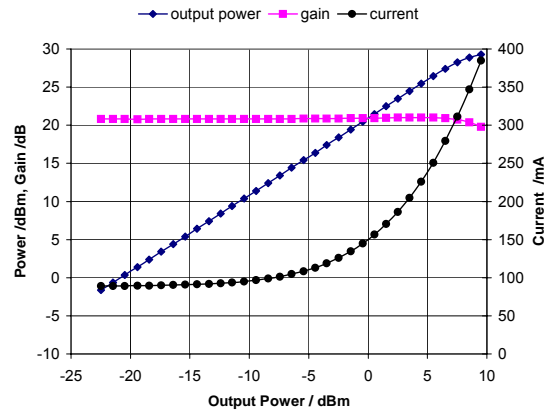
Figure 1
 (Vc = 3.3V, VREF = 2.85V, Icq = 65mA)

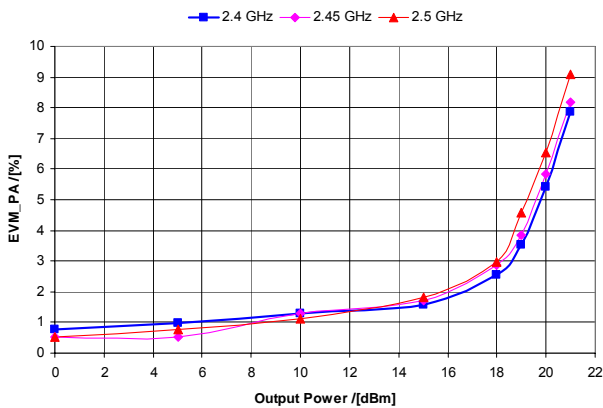
3.3V POWER SWEEP

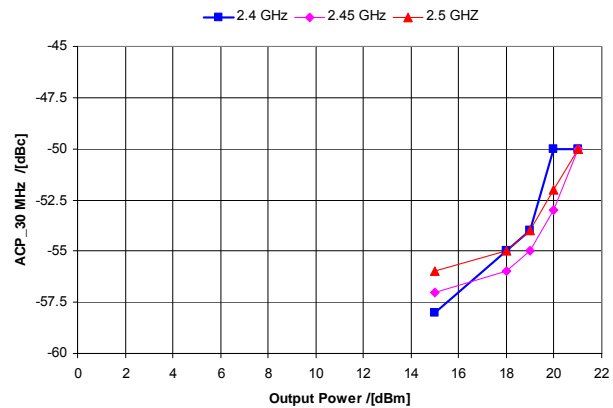
Figure 2
 (Vc = 3.3V, Vref = 2.85V, Icq = 65mA, frequency=2.45 GHz, P1dB=25 dBm)

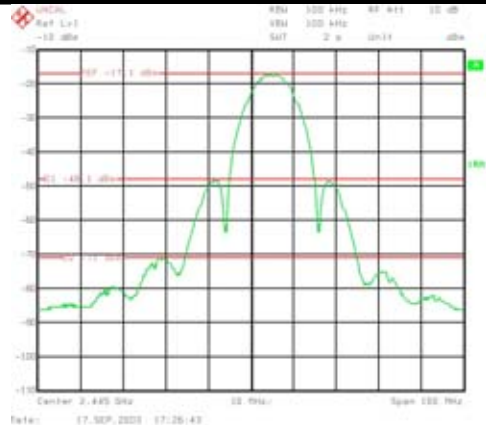
3.3V EVM DATA

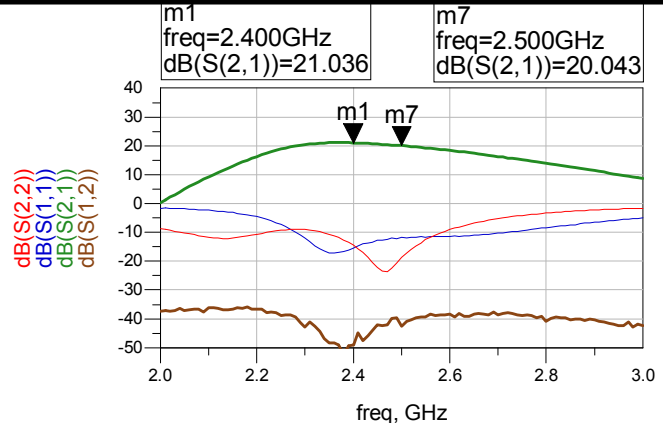
Figure 3 – EVM Data with 54Mb/s 64 QAM OFDM
 (Vc = 3.3V, Vref = 2.85V, Icq = 65mA)

3.3V ACP DATA

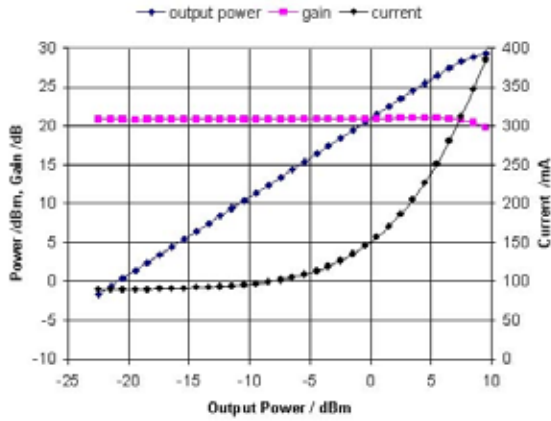
Figure 4 – ACP Data with 54MB/s 64 QAM OFDM
 (Vc = 3.3V, Vref = 2.85V, Icq = 65mA)

3.3V SPECTRUM WITH 23DBM

Figure 5 – Spectrum with 23dBm 11Mb/s CCK
 (Vc = 3.3V, Vref = 2.85V, Icq = 65mA, Ic = 171mA)

5V S PARAMETER DATA

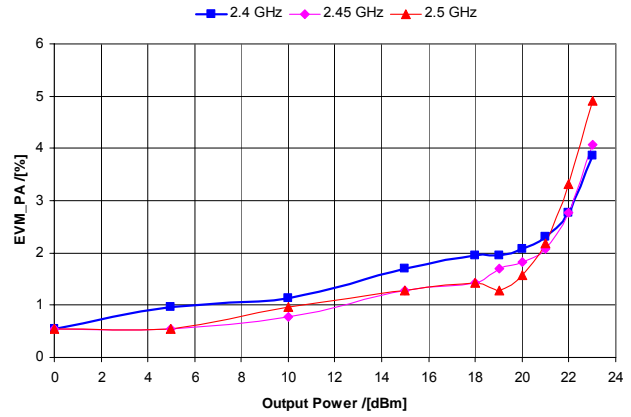
Figure 6 – S-Parameter Data
 (Vc = 5V, Vref = 2.85V, Icq = 80mA)

5V POWER SWEEP

Figure 7 – Power Sweep

(Vc = 5V, Vref = 2.85V, Icq = 80mA, frequency=2.45 GHz, P1dB=29 dBm)

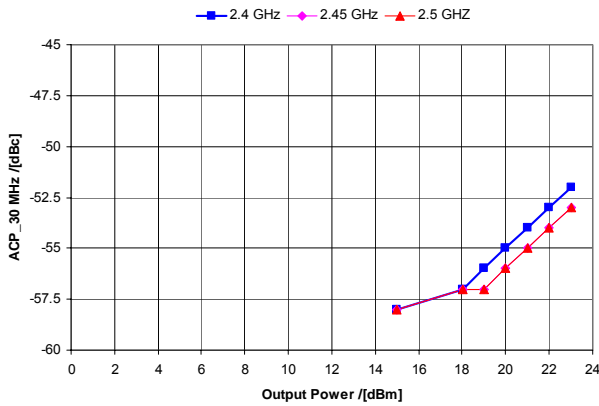
5V EVM DATA WITH 54MB/S

Figure 8 – EVM Data with 54Mb/s 64QAM OFDM

(Vc = 5V, Vref = 2.85V, Icq = 80mA)

5V ACP DATA WITH 54MB/S

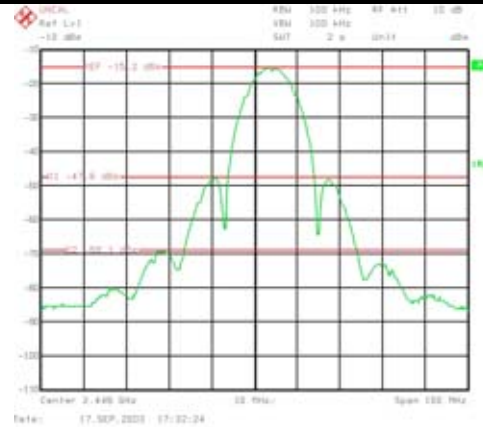
Figure 9 – ACP Data with 54Mb/s 64 QAM OFDM

(Vc = 5V, Vref = 2.85V, Icq = 80mA)

5V SPECTRUM WITH 25DMB

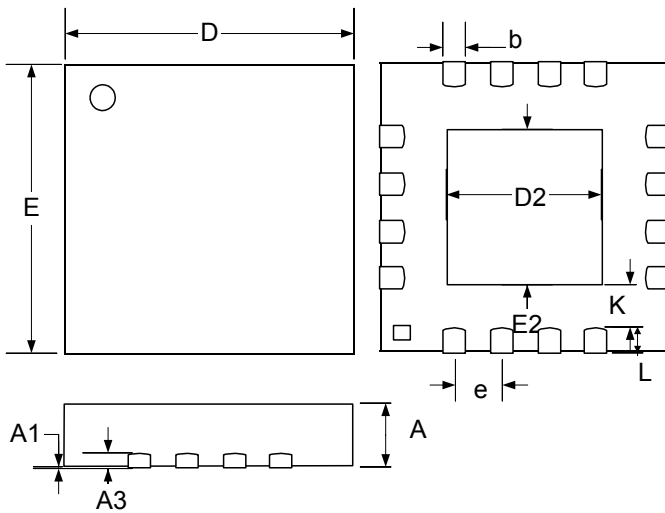
Figure 10 – Spectrum with 25dBm 11Mb/s CCK

(Vc = 5V, Vref = 2.85V, Icq = 80mA, Ic = 214mA, Frequency = 2.45GHz)

PACKAGE DIMENSIONS
LQ 16-Pin MLPQ 3x3 (67x67 mil DAP)

Dim	MILLIMETERS		INCHES	
	MIN	MAX	MIN	MAX
A	0.80	1.00	0.031	0.039
A1	0	0.05	0	0.002
A3	0.20 REF		0.008 REF	
b	0.18	0.30	0.007	0.012
D	3.00 BSC		0.118 BSC	
E	3.00 BSC		0.118 BSC	
e	0.50 BSC		0.020 BSC	
D2	1.30	1.55	0.051	0.061
E2	1.30	1.55	0.051	0.061
K	0.2	-	0.008	-
L	0.35	0.50	0.012	0.020

Note:

- Dimensions do not include mold flash or protrusions; these shall not exceed 0.155mm(.006") on any side. Lead dimension shall not include solder coverage.



Microsemi[®]

LX5510

InGaP HBT 2.4 – 2.5 GHz Power Amplifier

DATA SHEET

NOTES

PRODUCT PRELIMINARY DATA – Information contained in this document is pre-production data, and is proprietary to Microsemi. It may not be modified in any way without the express written consent of Microsemi. Product referred to herein is not guaranteed to achieve preliminary or production status and product specifications, configurations, and availability may change at any time.