

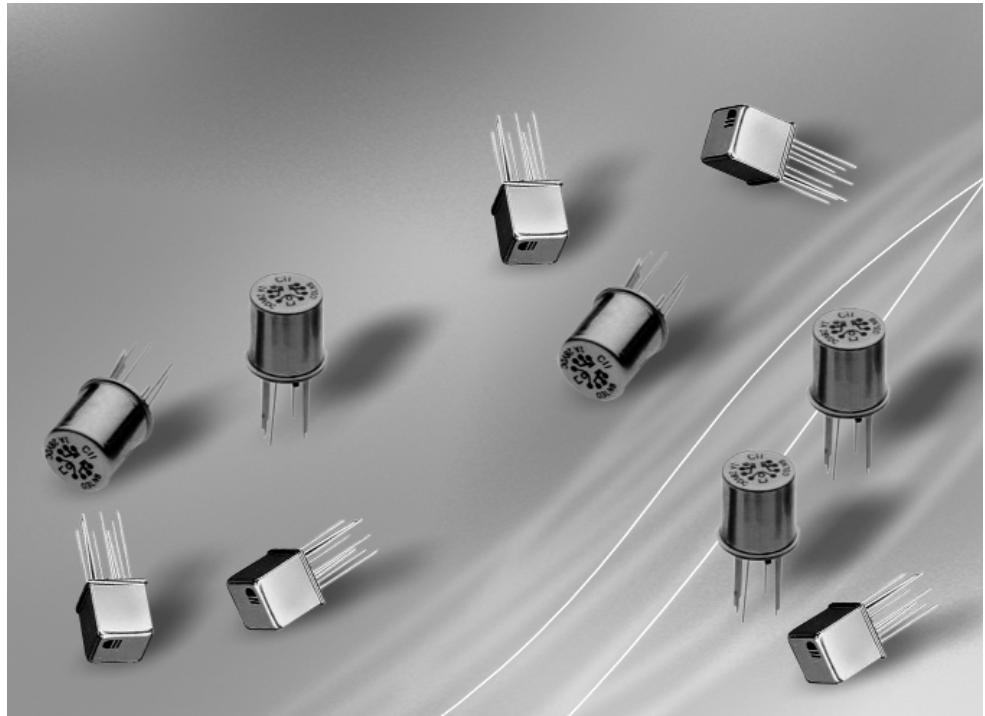

Microwave Switching, Hermetically Sealed, DPDT

Product Facts

- Excellent signal isolation, stable insertion loss and low VSWR.
- Provide repeatable RF performance at frequencies up to the 3 GHz. level (MW3/MW3HP), 4 GHz. level (MW4/MW4HP) & 6 GHz. level (MW6/MW6HP).
- Standard versions for applications ranging from wireless communications to precision high-speed test equipment.
- High performance (HP) versions for use under more demanding environmental conditions.
- Standard or sensitive (S) coils are offered in a range of DC input voltages.
- 2 Form C (DPDT) contacts rated low-level to 1 amp.
- Extended mechanical life expectancy of 10 million operations.
- Robust, hermetically sealed enclosure.



These CII relays provide microwave frequency switching in a hermetically sealed, subminiature package.

Both standard and high performance models are offered in 3 GHz., 4 GHz. and 6 GHz. types.

Standard models (MW3, MW4 and MW6) perform in temperature ranges from -55°C to +85°C and withstand 10G vibration and 30G shock.

High performance models (MW3HP, MW4HP and MW6HP) offer extended temperature ratings of -65°C to +125°C while providing 30G's vibration and 100G's shock (75G's for MW3) environmental ratings.

All are available with either standard or sensitive DC coils. Nominal coil power is 367-500mW (model dependent) for standard coils and 169-250mW for sensitive coils.

Signal isolation is 18dB at 6 GHz. (MW6/MW6HP), 18dB at 4 GHz. (MW4/MW4HP), and 22dB at 3 GHz. (MW3/MW3HP).

Insertion loss is 0.38dB for MW6/MW6HP, 0.27dB for MW4/MW4HP, and 0.36dB for MW3/MW3HP.

VSWR is a low 1.30:1 @ 6GHz. for MW6/MW6HP, 1.36:1 @ 4GHz. for MW4/MW4HP, and 1.24:1 @ 3GHz. for MW3/MW3HP.

**MW3 & MW3HP Models  
3 GHz. Switching**
**Electrical Characteristics**
**Contact Arrangement:**

2 Form C (DPDT)

**Contact Resistance:**

 Before life: 100 milliohms, max  
(measured @ 10mA @ 6VDC.)  
After life: 200 milliohms, max  
(measured @ 1A @ 28VDC.)

**Mechanical Life Expectancy:**

10 million operations

**Coil Voltages:**

 5, 12, 18 & 26.5VDC (MW3)  
5, 6, 9, 12, 18 & 26.5VDC (MW3HP)

**Coil Power (mw max @25°C):**

MW3	MW3S	MW3HP	MW3HPS
675	565	673	563

**Duty Cycle:**

Continuous

**Pick-up Voltage:**

 MW3: Approx 70% of nominal.  
MW3HP: Approx 50% of nominal.

**Pick-up Sensitivity (mw max @25°C):**

MW3	MW3S	MW3HP	MW3HPS
180	90	146	68

**Operating Characteristics**
**Timing:**

Operate Time (ms max.)

MW3	MW3S	MW3HP	MW3HPS
4.0	6.0	2.0	4.0

Release Time (ms max.)

MW3	MW3S	MW3HP	MW3HPS
3.0	3.0	1.5	2.0

Bounce Time (ms max.)

MW3	MW3S	MW3HP	MW3HPS
-	-	1.5	1.5

**Dielectric Withstanding Voltage:**

 Between Open Contacts,  
Between Adjacent Contacts and  
Between Contacts and Coil:  
MW3 types: 350Vrms, 60 Hz.  
MW3HP types: 500Vrms, 60 Hz.

**Insulation Resistance:**

1,000 megohms @ 500VDC.

**Environmental Characteristics**
**Temperature Range:**

 MW3 types: -55°C to +85°C.  
MW3HP types: -65°C to +125°C.

**Weight:**

 MW3, MW3HP: 0.09 oz. (2.55 g)  
MW3S, MW3HPS: 0.12 oz. (3.40 g).

**Vibration Resistance:**

 MW3 types: 10 G's, 10-500 Hz.  
MW3HP types: 30 G's, 10-3,000 Hz

**Shock Resistance:**

 MW3 types: 30 G's, 6 ± 1 ms.  
MW3HP types: 75 G's, 6 ± 1 ms.

**Contact Ratings**

Contact Load	Type	Operations (min.)
1.0A @ 28VDC	Resistive	100,000
200mA @ 28VDC (300mH)*	Inductive	100,000
30µA @ 50mVDC	Low Level	10,000,000

\* The inductive rating is only applicable to high performance models (MW3HP and MW3HPS).

**Coil Data**
**MW3 Models**

Nominal Coil Voltage (VDC)	Coil Resistance In Ohms ±20% @ 25°C	Pickup Voltage VDC (Max.) @ 25°C	Nominal Coil Power (mw) @ 25°C	Maximum Coil Voltage	Coil Designator
----------------------------	-------------------------------------	----------------------------------	--------------------------------	----------------------	-----------------

**Standard Coil**

5.0	50	3.6	500	5.8	5
12.0	390	8.4	369	16.0	12
18.0	880	13.0	368	24.0	18
26.5	1,560	17.0	450	32.0	26

**Sensitive Coil**

5.0	100	3.5	250	7.5	5
12.0	850	9.0	169	20.0	12
18.0	1,600	13.5	203	30.0	18
26.5	3,300	18.0	213	40.0	26

**MW3HP (High Performance) Models**

Nominal Coil Voltage (VDC)	Coil Res. in Ohms ±10% @ 25°C	Pickup V VDC (Max.) @25°C	Release V VDC (Max.) @25°C	Release V VDC (Min.) @25°C	Nominal Coil Power (mw) @25°C	Maximum Coil Voltage	Coil Designator
----------------------------	-------------------------------	---------------------------	----------------------------	----------------------------	-------------------------------	----------------------	-----------------

**Standard Coil**

5.0	50	2.7	1.4	0.22	500	5.8	5
6.0	98	3.5	2.0	0.28	367	8.0	6
9.0	220	5.3	3.0	0.54	368	12.0	9
12.0	390	7.0	4.0	0.63	369	16.0	12
18.0	880	10.5	6.0	0.91	368	24.0	18
26.5	1,560	14.2	8.0	1.37	450	32.0	26

**Sensitive Coil**

5.0	100	2.6	1.4	0.23	250	7.5	5
6.0	200	3.4	2.0	0.28	180	10.0	6
9.0	400	4.85	3.0	0.55	203	15.0	9
12.0	850	7.0	4.0	0.64	169	20.0	12
18.0	1,600	9.8	6.0	0.92	203	30.0	18
26.5	3,300	14.0	8.0	1.4	213	40.0	26



**MW3 & MW3HP Models  
3 GHz. Switching**

**Insertion Loss & VSWR: NO Contacts**

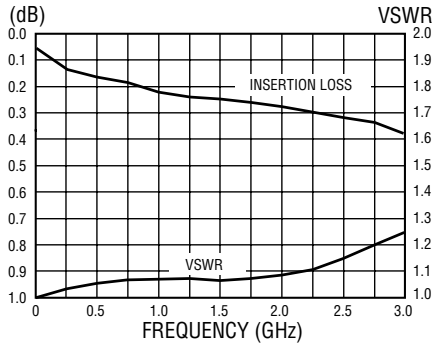

**Insertion Loss & VSWR: NC Contacts**

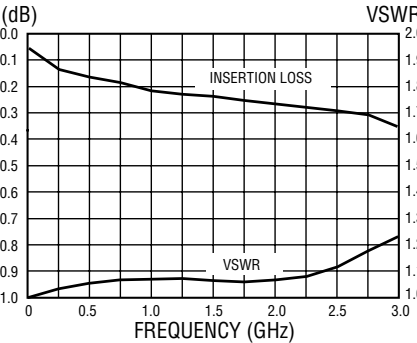

**Isolation**

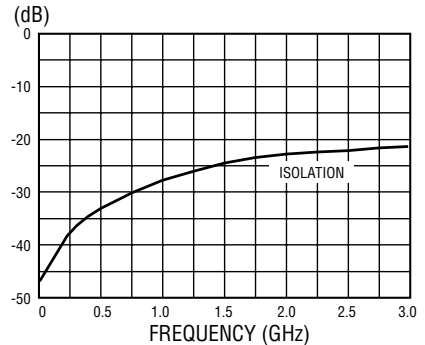

**Test Conditions**

**Test Board:** 0.031" double sided copper clad, PTFE based laminate.

**Connections:** Relay header is soldered to ground plane. Relay terminals are soldered to through holes. SMA connectors are soldered to circuit traces.

**Temperature:** Room ambient.

**Signal Strength:** 0 dBm.

**Notes:** 1. Unused terminals were terminated with 50 ohm impedance load. 2. All readings are typical.

**Enclosures**

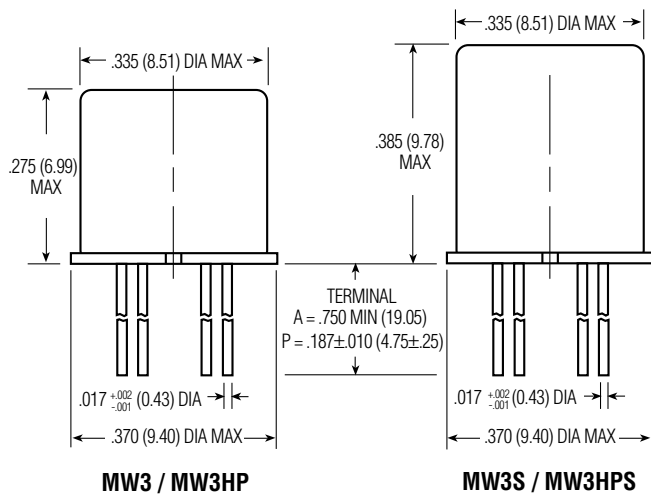

**Header**

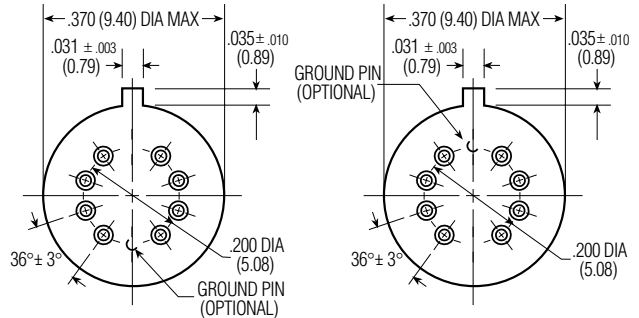

**Ground Pin Position "G"**

**Ground Pin Position "E"**

For other ground pin configurations consult factory.

**Header and Terminal Finish:**  
Nickel plated on MW3 & MW3S.  
Tin-lead plated on MW3HP & MW3HPS.

**Part Numbering System**

<b>Typical Part Number</b>	MW3	S	-5	A	G
<b>Series:</b>	MW3 = 3 GHz. switching relay MW3HP = High performance 3 GHz. switching relay				
<b>Coil Sensitivity:</b>	Leave Blank = Standard Coil      S = Sensitive Coil				
<b>Coil Designator:</b>	5 = 5VDC      6 = 6VDC†      9 = 9VDC† 12 = 12VDC      18 = 18VDC      26 = 26.5VDC † 6 and 9 volt coil only available on high performance models.				
<b>Terminal Length:</b>	A = 0.750 in (19.05 mm)      P = 0.187 ± 0.010 in (4.75 ± 0.25 mm)				
<b>Ground Pin Position (see header drawings above):</b>	G = Opposite locating tab      E = Near locating tab. Consult factory for other ground pin configurations.				

**Wiring Diagram**

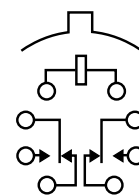

**Terminal View**

**MW4 & MW4HP Models  
4 GHz. Switching**
**Electrical Characteristics**

**Contact Arrangement:**  
2 Form C (DPDT)

**Contact Resistance:**  
Before life: 100 milliohms, max  
(measured @ 10mA @ 6VDC.)  
After life: 200 milliohms, max  
(measured @ 1A @ 28VDC.)

**Mechanical Life Expectancy:**  
10 million operations

**Coil Voltages:**  
5, 12, 18 & 26.5VDC (MW4)  
5, 6, 9, 12, 18 & 26.5VDC (MW4HP)

**Coil Power (mw max @25°C):**  
MW4 MW4S MW4HP MW4HPS  
675 565 673 563

**Duty Cycle:**  
Continuous

**Pick-up Voltage:**  
MW4: Approx 70% of nominal.  
MW4HP: Approx 50% of nominal.

**Pick-up Sensitivity (mw max @25°C):**  
MW4 MW4S MW4HP MW4HPS  
180 90 123 68

**Operating Characteristics**

**Timing:**  
Operate Time (ms max.)  
MW4 MW4S MW4HP MW4HPS  
4.0 6.0 2.0 4.0  
Release Time (ms max.)  
MW4 MW4S MW4HP MW4HPS  
3.0 3.0 1.5 2.0  
Bounce Time (ms max.)  
MW4 MW4S MW4HP MW4HPS  
- - 1.5 1.5

**Dielectric Withstanding Voltage:**  
Between Open Contacts,  
Between Adjacent Contacts and  
Between Contacts and Coil:  
MW4 types: 350Vrms, 60 Hz.  
MW4HP types: 500Vrms, 60 Hz.

**Insulation Resistance:**  
1,000 megohms @ 500VDC.

**Environmental Characteristics**

**Temperature Range:**  
MW4 types: -55°C to +85°C.  
MW4HP types: -65°C to +125°C.

**Weight:**  
MW4, MW4HP: 0.09 oz. (2.55 g)  
MW4S, MW4HPS: 0.12 oz. (3.40 g).

**Vibration Resistance:**  
MW4 types: 10 G's, 10-500 Hz.  
MW4HP types: 30 G's, 10-3,000 Hz

**Shock Resistance:**  
MW4 types: 30 G's, 6 ± 1 ms.  
MW4HP types: 100 G's, 6 ± 1 ms.

**Contact Ratings**

Contact Load	Type	Operations (min.)
1.0A @ 28VDC	Resistive	100,000
200mA @ 28VDC (300mH)*	Inductive	100,000
30µA @ 50mVDC	Low Level	10,000,000

\* The inductive rating is only applicable to high performance models (MW4HP and MW4HPS).

**Coil Data**
**MW4 Models**

Nominal Coil Voltage (VDC)	Coil Resistance In Ohms ±20% @ 25°C	Pickup Voltage VDC (Max.) @ 25°C	Nominal Coil Power (mw) @ 25°C	Maximum Coil Voltage	Coil Designator
----------------------------	-------------------------------------	----------------------------------	--------------------------------	----------------------	-----------------

**Standard Coil**

5.0	50	3.6	500	5.8	5
12.0	390	8.4	369	16.0	12
18.0	880	13.0	368	24.0	18
26.5	1,560	17.0	450	32.0	26

**Sensitive Coil**

5.0	100	3.5	250	7.5	5
12.0	850	9.0	169	20.0	12
18.0	1,600	13.5	203	30.0	18
26.5	3,300	18.0	213	40.0	26

**MW4HP (High Performance) Models**

Nominal Coil Voltage (VDC)	Coil Res. in Ohms ±10% @ 25°C	Pickup V VDC (Max.) @25°C	Release V VDC (Max.) @25°C	Release V VDC (Min.) @25°C	Nominal Coil Power (mw) @25°C	Maximum Coil Voltage	Coil Designator
----------------------------	-------------------------------	---------------------------	----------------------------	----------------------------	-------------------------------	----------------------	-----------------

**Standard Coil**

5.0	50	2.7	1.4	0.22	500	5.8	5
6.0	98	3.5	2.0	0.28	367	8.0	6
9.0	220	5.3	3.0	0.54	368	12.0	9
12.0	390	7.0	4.0	0.63	369	16.0	12
18.0	880	10.5	6.0	0.91	368	24.0	18
26.5	1,560	14.2	8.0	1.37	450	32.0	26

**Sensitive Coil**

5.0	100	2.6	1.4	0.23	250	7.5	5
6.0	200	3.4	2.0	0.28	180	10.0	6
9.0	400	4.85	3.0	0.55	203	15.0	9
12.0	850	7.0	4.0	0.64	169	20.0	12
18.0	1,600	9.8	6.0	0.92	203	30.0	18
26.5	3,300	14.0	8.0	1.4	213	40.0	26

**MW4 & MW4HP Models  
4 GHz. Switching**

**Insertion Loss & VSWR: NO Contacts**

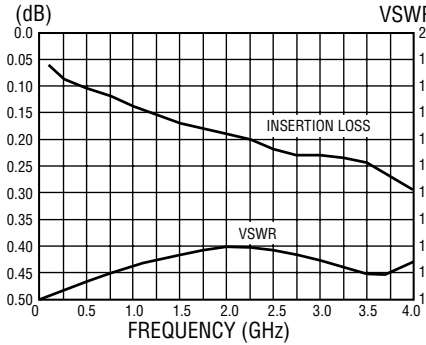

**Insertion Loss & VSWR: NC Contacts**

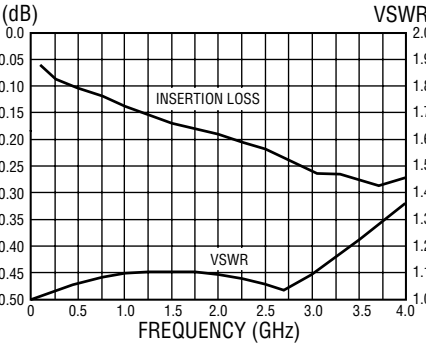

**Isolation**

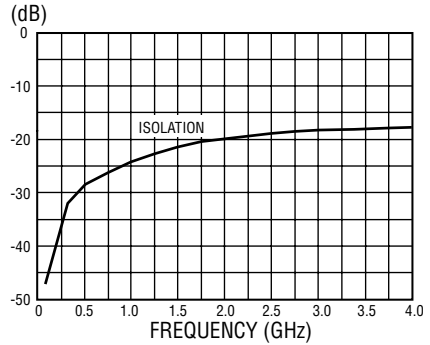

**Test Conditions**

**Test Board:** 0.031" double sided copper clad, PTFE based laminate.  
**Connections:** Relay header is soldered to ground plane. Relay terminals are soldered to through holes. SMA connectors are soldered to circuit traces.  
**Temperature:** Room ambient.  
**Signal Strength:** 0 dBm.  
**Notes:** 1. Unused terminals were terminated with 50 ohm impedance load. 2. All readings are typical.

**Enclosures**

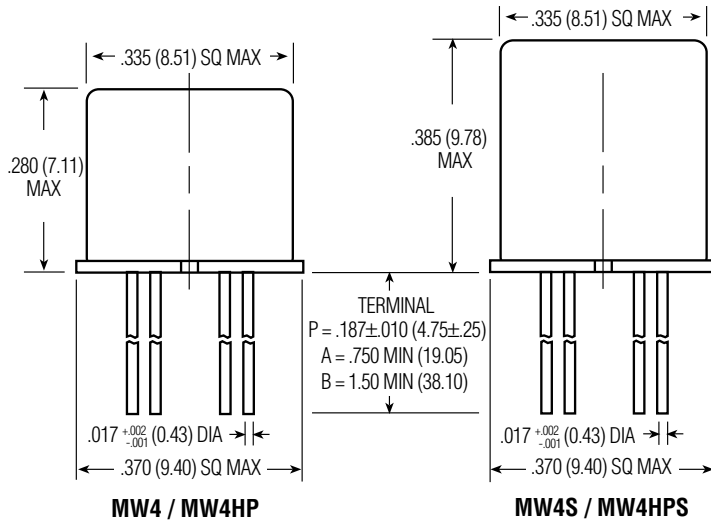

**Header**

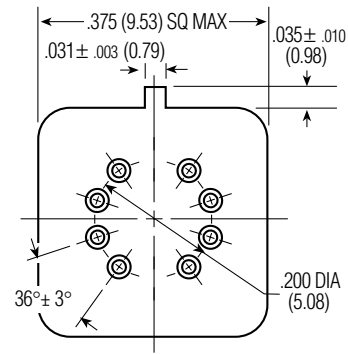

**Header and Terminal Finish:  
Gold plated**

**Part Numbering System**

**Typical Part Number** MW4 S - 5 P

**Series:**  
 MW4 = 4 GHz. switching relay  
 MW4HP = High performance 4 GHz. switching relay

**Coil Sensitivity:**  
 Leave Blank = Standard Coil    S = Sensitive Coil

**Coil Designator:**  
 5 = 5VDC      6 = 6VDC†      9 = 9VDC†  
 12 = 12VDC    18 = 18VDC      26 = 26.5VDC  
 † 6 and 9 volt coil only available on high performance models.

**Terminal Length:**  
 A = 0.750 in (19.05 mm)  
 B = 1.50 in (38.105 mm) – only available on high performance models  
 P = 0.187 ± 0.010 in (4.75 ± 0.25 mm)

**Wiring Diagram**

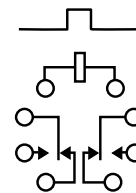

**Terminal View**

**MW6 & MW6HP Models  
6 GHz. Switching**
**Electrical Characteristics**
**Contact Arrangement:**  
2 Form C (DPDT)

**Contact Resistance:**  
Before life: 100 milliohms, max  
(measured @ 10mA @ 6VDC.)  
After life: 200 milliohms, max  
(measured @ 1A @ 28VDC.)

**Mechanical Life Expectancy:**  
10 million operations

**Coil Voltages:**  
5, 12, 18 & 26.5VDC (MW6)  
5, 6, 9, 12, 18 & 26.5VDC (MW6HP)

**Coil Power** (mw max @25°C):  

MW6	MW6S	MW6HP	MW6HPS
675	565	673	563

**Duty Cycle:**  
Continuous

**Pick-up Voltage:**  
MW6: Approx 70% of nominal.  
MW6HP: Approx 50% of nominal.

**Pick-up Sensitivity** (mw max @25°C):  

MW6	MW6S	MW6HP	MW6HPS
180	90	123	68

**Operating Characteristics**
**Timing:**  
Operate Time (ms max.)  

MW6	MW6S	MW6HP	MW6HPS
4.0	6.0	2.0	4.0

Release Time (ms max.)  

MW6	MW6S	MW6HP	MW6HPS
3.0	3.0	1.5	2.0

Bounce Time (ms max.)  

MW6	MW6S	MW6HP	MW6HPS
-	-	1.5	1.5

**Dielectric Withstanding Voltage:**  
Between Open Contacts,  
Between Adjacent Contacts and  
Between Contacts and Coil:  
MW6 types: 350Vrms, 60 Hz.  
MW6HP types: 500Vrms, 60 Hz.

**Insulation Resistance:**  
1,000 megohms @ 500VDC.

**Environmental Characteristics**
**Temperature Range:**  
MW6 types: -55°C to +85°C.  
MW6HP types: -65°C to +125°C.

**Weight:**  
MW6, MW6HP: 0.09 oz. (2.55 g)  
MW6S, MW6HPS: 0.12 oz. (3.40 g).

**Vibration Resistance:**  
MW6 types: 10 G's, 10-500 Hz.  
MW6HP types: 30 G's, 10-3,000 Hz

**Shock Resistance:**  
MW6 types: 30 G's, 6 ± 1 ms.  
MW6HP types: 100 G's, 6 ± 1 ms.

**Contact Ratings**

Contact Load	Type	Operations (min.)
1.0A @ 28VDC	Resistive	100,000
200mA @ 28VDC (300mH)*	Inductive	100,000
30µA @ 50mVDC	Low Level	10,000,000

\* The inductive rating is only applicable to high performance models (MW6HP and MW6HPS).

**Coil Data**
**MW6 Models**

Nominal Coil Voltage (VDC)	Coil Resistance In Ohms ±20% @ 25°C	Pickup Voltage VDC (Max.) @ 25°C	Nominal Coil Power (mw) @ 25°C	Maximum Coil Voltage	Coil Designator
<b>Standard Coil</b>					
5.0	50	3.6	500	5.8	5
12.0	390	8.4	369	16.0	12
18.0	880	13.0	368	24.0	18
26.5	1,560	17.0	450	32.0	26

**Sensitive Coil**

5.0	100	3.5	250	7.5	5
12.0	850	9.0	169	20.0	12
18.0	1,600	13.5	203	30.0	18
26.5	3,300	18.0	213	40.0	26

**MW6HP (High Performance) Models**

Nominal Coil Voltage (VDC)	Coil Res. in Ohms ±10% @ 25°C	Pickup V VDC (Max.) @25°C	Release V VDC (Max.) @25°C	Release V VDC (Min.) @25°C	Nominal Coil Power (mw) @25°C	Maximum Coil Voltage	Coil Designator
<b>Standard Coil</b>							
5.0	50	2.7	1.4	0.22	500	5.8	5
6.0	98	3.5	2.0	0.28	367	8.0	6
9.0	220	5.3	3.0	0.54	368	12.0	9
12.0	390	7.0	4.0	0.63	369	16.0	12
18.0	880	10.5	6.0	0.91	368	24.0	18
26.5	1,560	14.2	8.0	1.37	450	32.0	26

**Sensitive Coil**

5.0	100	2.6	1.4	0.23	250	7.5	5
6.0	200	3.4	2.0	0.28	180	10.0	6
9.0	400	4.85	3.0	0.55	203	15.0	9
12.0	850	7.0	4.0	0.64	169	20.0	12
18.0	1,600	9.8	6.0	0.92	203	30.0	18
26.5	3,300	14.0	8.0	1.4	213	40.0	26



#### MW6 & MW6HP Models 6 GHz. Switching

##### Insertion Loss & VSWR: NO Contacts

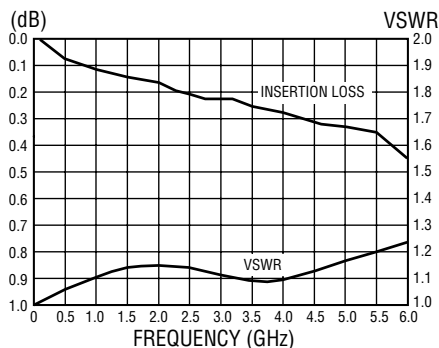

##### Insertion Loss & VSWR: NC Contacts

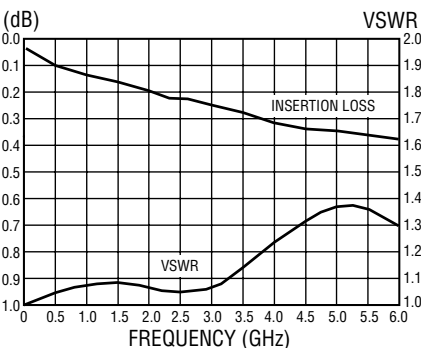

##### Isolation

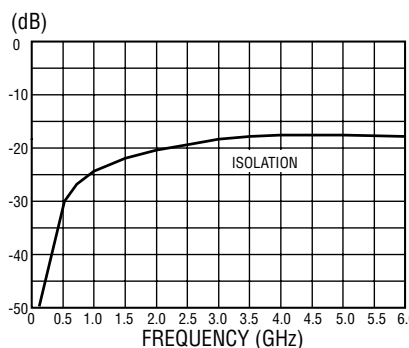

#### Test Conditions

**Test Board:** 0.031" double sided copper clad, PTFE based laminate.

**Connections:** Relay header is soldered to ground plane. Relay terminals are soldered to through holes. SMA connectors are soldered to circuit traces.

**Temperature:** Room ambient.

**Signal Strength:** 0 dBm.

**Notes:** 1. Unused terminals were terminated with 50 ohm impedance load. 2. All readings are typical.

#### Enclosures

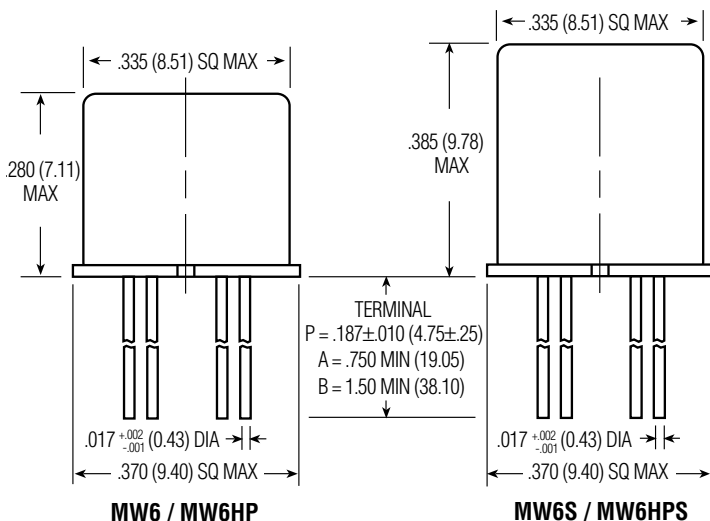

#### Header

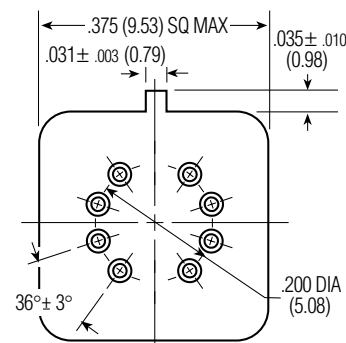

**Header and Terminal Finish:**  
Gold plated

#### Part Numbering System

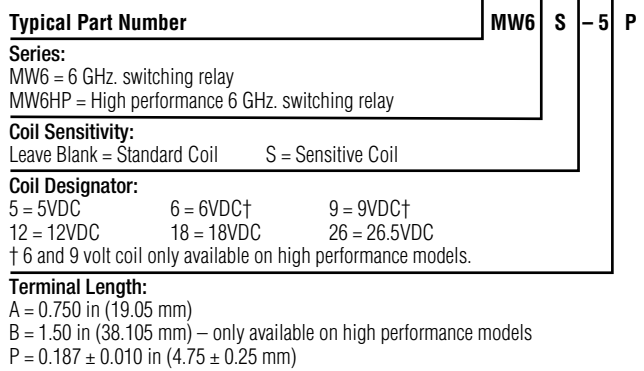

#### Wiring Diagram

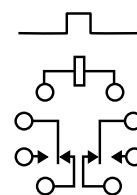

#### Terminal View

**Americas**

**Argentina** – Buenos Aires  
 Phone: +54-11-4733-2200  
 Fax: +54-11-4733-2250

**Brazil** – São Paulo  
 Phone: +55-11-3611-1311  
 Fax: +55-11-3611-0397

**Canada** – Markham  
 Phone: +905-475-6222  
 Fax: +905-474-5520  
**Product Information Center:  
 (Technical Support)**  
 Phone: +905-470-4425  
 Fax: +905-474-5525

**Colombia** – Bogota  
 Phone: +57-1-240-9396  
 Fax: +57-1-660-0206

**Mexico** – Mexico City  
 Phone: +52-55-5-729-0425  
 Fax: +52-55-5-398-1430

**United States** – Harrisburg, PA  
 Phone: +717-564-0100  
 Fax: +717-986-7575  
**Product Information Center:  
 (Technical Support)**  
 Phone: +800-522-6752  
 Fax: +717-986-7575

**For Latin/South American  
 Countries not shown**  
 Phone: +57-1-240-9396  
 Fax: +57-1-660-0206

**Asia/Pacific**

**Australia** – Sydney  
 Phone: +61-2-9840-8200  
 Fax: +61-2-9899-5649  
**Product Information Center:  
 (Technical Support)**  
 Phone: +61-2-9554-2600  
 Fax: +61-2-9502-2556

**India** – Bangalore  
 Phone: +91-80-841-0200  
 Fax: +91-80-841-0210

**Indonesia** – Jakarta  
 Phone: +6221-526-7852  
 Fax: +6221-526-7856

**Japan** – Kawasaki, Kanagawa  
 Phone: +81-44-844-8079  
 Fax: +81-44-844-8733  
**Product Information Center:  
 (Technical Support)**  
 Phone: +81-44-844-8013  
 Fax: +81-44-812-3200  
**Raychem Products**  
 Phone: +81-44-900-5102  
 Fax: +81-44-5025-5027

**Korea** – Seoul  
 Phone: +82-2-3274-0535  
 Fax: +82-2-3274-0524/0531

**Malaysia** – Selangor  
 Phone: +60-3-7053055  
 Fax: +60-3-7053066

**New Zealand** – Auckland  
 Phone: +64-9-634-4580  
 Fax: +64-9-634-4586

**Philippines** – Makati City  
 Phone: +632-867-8641  
 Fax: +632-867-8661

**People's Republic of China**  
 Hong Kong  
 Phone: +852-2735-1628  
 Fax: +852-2735-0243

Shanghai  
 Phone: +86-21-6485-0602  
 Fax: +86-21-6485-0728

Shunde  
 Phone: +86-765-775-1368  
 Fax: +86-765-775-2823

**Singapore** – Singapore  
 Phone: +65-4820-3111  
 Fax: +65-4821-012

**Raychem Products**  
 Phone: +65-4866-151  
 Fax: +65-6545-514

**Taiwan** – Taipei  
 Phone: +886-2-2664-9977  
 Fax: +886-2-2664-9900

**Thailand** – Bangkok  
 Phone: +66-2-955-0500  
 Fax: +66-2-955-0505

**Vietnam** – Ho Chi Minh City  
 Phone: +84-8-8232-546/7  
 Fax: +84-8-8221-443

**Europe/Middle East/Africa**

**Austria** – Vienna  
 Phone: +43-190-560-0  
 Fax: +43-190-560-1333

**Belgium** – Kessel-Lo  
 Phone: +32-16-352-300  
 Fax: +32-16-352-352

**Bulgaria** – Sofia  
 Phone: +359-2-971-2152  
 Fax: +359-2-971-2153

**Czech Republic** – Kurim  
 Phone: +420-5-41-162-111  
 Fax: +420-5-41-162-223

**Denmark** – Viby J  
 Phone: +45-70-15-52-00  
 Fax: +45-86-29-51-33

**Egypt** – Cairo  
 Phone: +20-2-417-76-47  
 Fax: +20-2-419-23-34

**Estonia** – Tallinn  
 Phone: +372-65-05-474  
 Fax: +372-65-05-470

**Finland** – Helsinki  
 Phone: +358-95-12-34-20  
 Fax: +358-95-12-34-250

**France** –  
 Cergy-Pontoise  
 Phone: +33-1-3420-8888  
 Fax: +33-1-3420-8600  
**Product Information Center:  
 (Technical Support)**  
 Phone: +33-1-3420-8943  
 Fax: +33-1-3420-8623

**France**  
**Tyco Electronics Export** –  
 St Ouen L'Aumone  
 Phone: +33-1-3440-7200  
 Fax: +33-1-3440-7220 or  
 +33-1-3440-7230

**Germany** – Bensheim  
 Phone: +49-6251-133-0  
 Fax: +49-6251-133-1600  
**Product Information Center:  
 (Technical Support)**  
 Phone: +49-6251-133-1999  
 Fax: +49-6251-133-1988

**Germany** – Langen  
 Phone: +49-6103-709-0  
 Fax: +49-6103-709-1223

**Germany** – Speyer  
 Phone: +49-6232-30-0  
 Fax: +49-6232-30-2243

**Germany**  
**HTS Division** – Neunkirchen  
 Phone: +49-2247-305-0  
 Fax: +49-2247-305-122

**Great Britain** –  
 Stanmore Middlesex  
 Phone: +44-181-954-2356  
 Fax: +44-181-954-6234  
**Product Information Center:  
 (Technical Support)**  
 Freephone GB: 0800-267-666  
 Phone: +44-141 810 8967...69  
 Fax: +44-141 810 8971  
**Great Britain** – Dorcan, Swindon  
**Raychem Products**  
 Phone: +44-1793-528171  
 Fax: +44-1793-572516

**Greece** – Athens  
 Phone: +30-1-9370-396/397  
 Fax: +30-1-9370-655

**Hungary** – Budapest  
 Phone: +36-1-289-1000  
 Fax: +36-1-289-1010

**Ireland** – Dublin  
 Phone: +353-1-820-3000  
 Fax: +353-1-820-9790

**Israel** – Yokneam  
 Phone: +972-4-959-0508  
 Fax: +972-4-959-0506

**Italy** – Collegno (Torino)  
 Phone: +39-011-4012-111  
 Fax: +39-011-4031-116

**Lithuania** – Vilnius  
 Phone: +370-5-21-31-402  
 Fax: +370-5-21-31-403

**Netherlands** – 's-Hertogenbosch  
 Phone: +31-73-6246-246  
 Fax: +31-73-6212-365  
**Product Information Center:  
 (Technical Support)**  
 Phone: +31-73-6246-999  
 Fax: +31-73-6246-998

**Norway** – Nesbru  
 Phone: +47-66-77-88-99  
 Fax: +47-66-77-88-55

**Poland** – Warsaw  
 Phone: +48-22-45-76-700  
 Fax: +48-22-45-76-720

**Romania** – Bucharest  
 Phone: +40-1-311-3479+3596  
 Fax: +40-1-312-0574

**Russia** – Moscow  
 Phone: +7-095-926-55-06...09  
 Fax: +7-095-926-55-05

**Russia** – St. Petersburg  
 Phone: +7-812-325-30-83  
 Fax: +7-812-325-32-88

**Scotland** – Dundee  
**Madison Cable Products**  
 Phone: +44-1382-508080  
 Fax: +44-1382-505060

**Slovakia** – Banská Bystrica  
 Phone: +421-48-415-20-11/12  
 Fax: +421-48-415-20-13

**Slovenia** – Ljubljana  
 Phone: +386-1561-3270  
 Fax: +386-1561-3240

**South Africa** – Port Elizabeth  
 Phone: +27-41-405-4500  
 Fax: +27-41-486-1314