

SONY

**CCD B/W VIDEO
CAMERA MODULE**

**XC-ST50/50CE
XC-ST30/30CE**



User's Guide

(Ver. 1.0) — English —

Table of Contents

OUTLINE	1
MAIN FEATURES	1
SPECIFICATIONS COMPARISON	2
SYSTEM CONFIGURATION	2
MAIN SPECIFICATIONS	3
CONNECTION DIAGRAM	4
LOCATION OF PARTS AND OPERATION	5
PHASE CONDITIONS OF EXTERNAL SYNCHRONIZATION	6
ELECTRONIC SHUTTER.....	7
RESTART RESET (R.R)	10
FRAME IMAGE OUTPUT WITH STROBE LIGHT	12
OUTPUT WAVEFORM TIMING CHART (XC-ST50 (EIA)/XC-ST30 (EIA))	13
TIMING CHART OF EXTERNAL TRIGGER SHUTTER - MODE 1	17
TIMING CHART OF EXTERNAL TRIGGER SHUTTER - MODE 2	23
DIMENSIONS	25
SPECTRAL RESPONSE CHARACTERISTICS (TYPICAL VALUE)	26
COMPARISON OF SPECTRAL RESPONSE CHARACTERISTICS (TYPICAL VALUE)	26
VARIOUS LENS SELECTION	27

OUTLINE

The XC-ST50/50CE and XC-ST30/30CE are compact, lightweight, black-and-white camera modules of a new concept, which are produced as input devices for image processing by using the latest technology. These models inherit the basic functions of the XC-75 (installing a 1/2-inch CCD) and the XC-73 (installing a 1/3-inch CCD), which are used in various types of devices and systems and win popularity in the machine vision field. The XC-ST50/50CE and XC-ST30/30CE provides an external trigger shutter that can catch a high-speed moving subject using an external signal. This enables a still image to be read in arbitrary timing. These two models are compatible with each other, thereby functioning in the same cabinet and by the same operation. The user can select a model according to the conditions of subjects and optical conditions. In addition, the XC-ST50/50CE and XC-ST30/30CE enable functions to be set on the rear panel for improved operability and have an internal configuration which implements significant shock and vibration resistance, allowing easy incorporation into machine vision equipment.

MAIN FEATURES

■ 1/2", 1/3" IT CCD

■ External trigger shutter function

(XC-ST50/ST30: 1/4 to 1/10,000 seconds,
XC-ST50CE/ST30CE: 1/4 to 1/8,000 seconds)

Inputting the trigger pulse gives one still image. This feature allows the capture of high-speed moving object.

■ Restart Reset (R.R) function

Inputting HD and VD signals (2 VD or more) continuously from the outside can catch one image at arbitrary time and control the exposure time of CCD.

This function is used for long exposures and strobe with frame image output.

■ Synchronization system: Internal/external HD/VD, and VS

(VS is used only during external synchronization.)

Inputting an HD/VD signal from the outside automatically establishes external synchronization.

This function is effective for controlling multiple cameras efficiently from the external system.

■ Setting each mode on rear panel:

The setting of each mode can be changed by selecting DIP and rotary switch.

Almost all switches are located on the rear panel. This feature permits easy setting after equipment is installed.

■ Compact and lightweight

■ C-mount

■ Excellent shock and vibration resistance

■ Compatibility

These models are the same in the size and functions as the XC-ST70. They can be operated in the same way as the XC-ST70 (installing 2/3-inch CCD). Therefore, they provide high compatibility.

SYSTEM CONFIGURATION

The components making up the system based on XC-ST50/ST50CE or XC-ST30/ST30CE video camera are as follows.

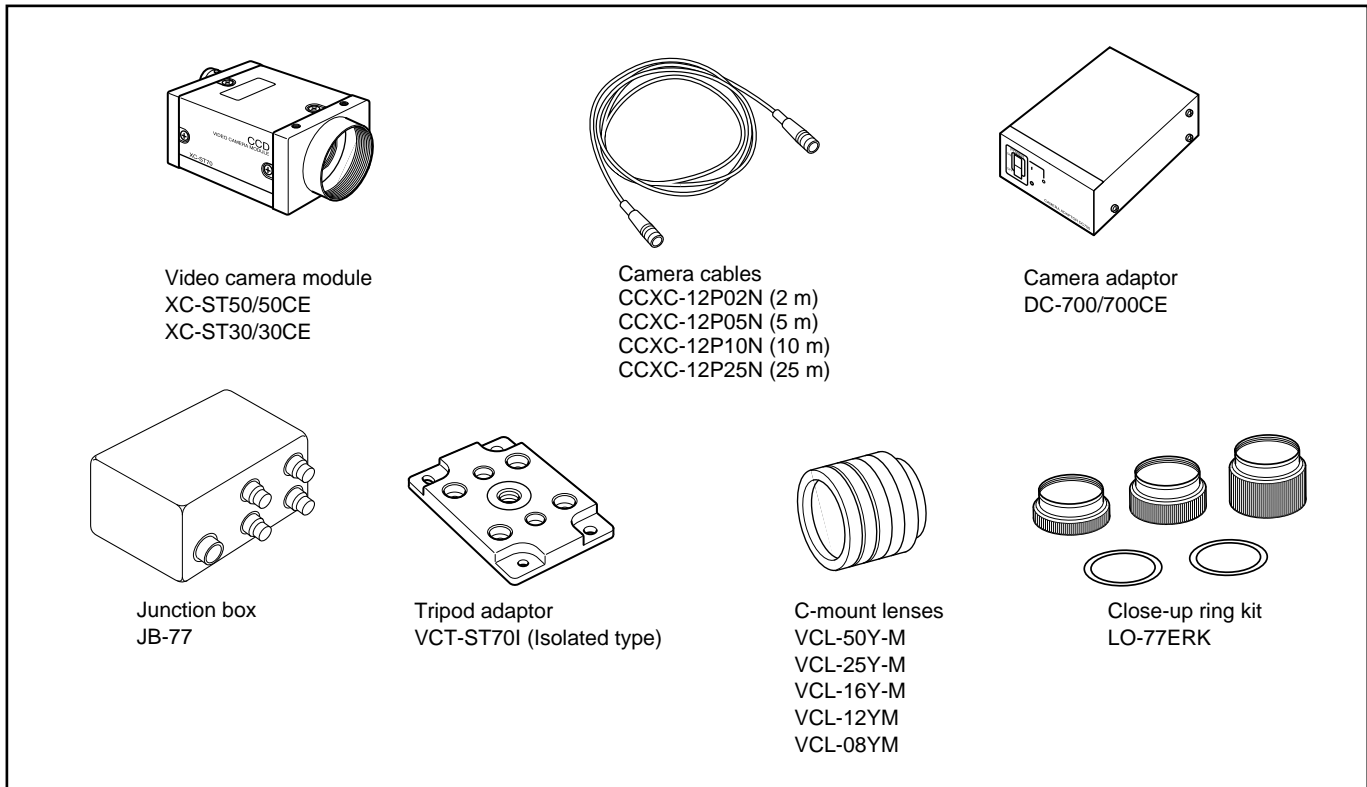

SPECIFICATIONS COMPARISON

	XC-ST50	XC-75	XC-ST30	XC-73
Image device	1/2-inch interline transfer CCD	1/2-inch interline transfer CCD	1/3-inch interline transfer CCD	1/3-inch interline transfer CCD
Effective picture elements	768 (H) ×494 (V)	768 (H) ×494 (V)	768 (H) ×494 (V)	768 (H) ×494 (V)
Lens mount	C mount	C mount	C mount	C mount
Scanning system	2:1 interlaced	2:1 interlaced	2:1 interlaced	2:1 interlaced
Sensitivity	400 lx F8	400 lx F4	400 lx F8	400 lx F4
Minimum illuminance	0.3 lx	3.0 lx	0.3 lx	3.0 lx
S/N ratio	60db	56db	56db	56db
Normal shutter	1/100 to 1/10,000	1/100 to 1/10,000	1/100 to 1/10,000	1/100 to 1/10,000
External trigger shutter	1/4 to 1/10,000 Can be changed by the trigger pulse width or rear panel switch.	1/100 to 1/1,600 Can be changed by the trigger and VD. Internal setting needs to be changed.	1/4 to 1/10,000 Can be changed by the trigger pulse width or rear panel switch.	1/100 to 1/1,600 Can be changed by the trigger and VD. Internal setting needs to be changed.
Dimensions	44 (W) ×29 (H) ×57.5 (D) mm	44 (W) ×29 (H) ×71 (D) mm	44 (W) ×29 (H) ×57.5 (D) mm	44 (W) ×29 (H) ×71 (D) mm
Mass	110 g	140 g	110 g	140 g
Shock resistance	10G (in the X, Y, and Z directions at 20 to 200 Hz)	7G (in the X, Y, and Z directions at 11 to 200 Hz)	10G (in the X, Y, and Z directions at 20 to 200 Hz)	7G (in the X, Y, and Z directions at 11 to 200 Hz)

MAIN SPECIFICATIONS

Image pickup device		Gain	AGC/Manual/Fixed (Can be selected using the switch on the rear panel.)
XC-ST50/50CE:	1/2-inch interline transfer CCD	Gamma correction	ON/OFF (Can be selected using the switch on the rear panel.)
XC-ST30/30CE:	1/3-inch interline transfer CCD	Electronic shutter	
Number of effective pixels		XC-ST50/ST30:	1/100 to 1/10,000 seconds
XC-ST50/ST30:	768(H) × 494(V)	XC-ST50CE/ST30CE:	1/120 to 1/10,000 seconds
XC-ST50CE/ST30CE:	752(H) × 582(V)	External trigger shutter	
CCD horizontal driving frequency		XC-ST50/ST30:	1/4 to 1/10,000 seconds
XC-ST50/ST30:	14.318 MHz	XC-ST50CE/ST30CE:	1/4 to 1/8,000 seconds
XC-ST50CE/ST30CE:	14.187 MHz	★ Set using the DIP switch on the rear panel, or continuously variable with the trigger pulse width.	
CCD vertical driving frequency		Supply voltage	+12 VDC (+10.5 V to 15V)
XC-ST50/ST30:	15.734 kHz	Power consumption	XC-ST50/50CE: 2.0 W XC-ST30/30CE: 1.9 W
XC-ST50CE/ST30CE:	15.625 kHz	Operating temperature	-5 °C to +45 °C
Signal system	EIA/CCIR	Storage temperature	-30 °C to +60 °C
Cell size		Performance assurance temperature	0 °C to +40 °C
XC-ST50:	8.4(H) × 9.8(V) μm	Operating humidity	20 to 80 % (Non-condensing)
XC-ST50CE:	8.6(H) × 8.3(V) μm	Storage humidity	20 to 95 % (Non-condensing)
XC-ST30:	6.35(H) × 7.4(V) μm	Vibration resistance	10G (For 20 minutes in the X, Y, and Z directions at 20 to 200 Hz)
XC-ST30CE:	6.5(H) × 6.25(V) μm	Shock resistance	70G
Lens mount	C mount	Outside dimensions	44(W) × 29(H) × 57.5(D) mm
Flange back	17.526 mm	Weight	110 g
Synchronization system	Internal/external (Selected automatically)	Standards	UL1492, FCC Class A Digital Device, and CE (EN50081-2 + EN50082-2)
External sync input/output	HD/VD (2 to 5 Vp-p) VS (Sync level: 0.3 Vp-p ^{+0.3V}) ★ Automatically selected according to the existence of an input signal when the selection switch on the rear panel is set to EXT.	Other	Restart Reset function Frame or field integration can be selected. Conforms to new 12-pin EIAJ assignment.
Allowable frequency deviation of external synchronization	± 1 % (in horizontal synchronous frequency)	Accessories	Lens mount cap (1) Instruction Manual (1)
Jitter	Within ± 50 nsec	External synchronization for each mode	
Scanning system	2:1 interlaced Non-interlaced (during external sync input)		
Horizontal resolution			
XC-ST50/ST30:	570 TV lines		
XC-ST50CE/ST30CE:	560 TV lines		
Sensitivity			
XC-ST50/50CE:	400 lx F8 (r=ON, 0 dB)		
XC-ST30/30CE:	400 lx F5.6 (r=ON, 0 dB)		
S/N ratio			
XC-ST50/50CE:	60 dB/58dB		
XC-ST30/30CE:	56 dB/54dB		
Minimum illuminance	0.3 lx (F1.4, AGC ON)		

Mode	Internal sync	External sync	
		HD/VD	VS
Normal	○	○	○
Normal shutter	○	○	○
External trigger shutter	Mode 1	○	×
	Mode 2	×	×
Restart Reset	×	○	×

○: Can be used.
×: Cannot be used.

CONNECTION DIAGRAM

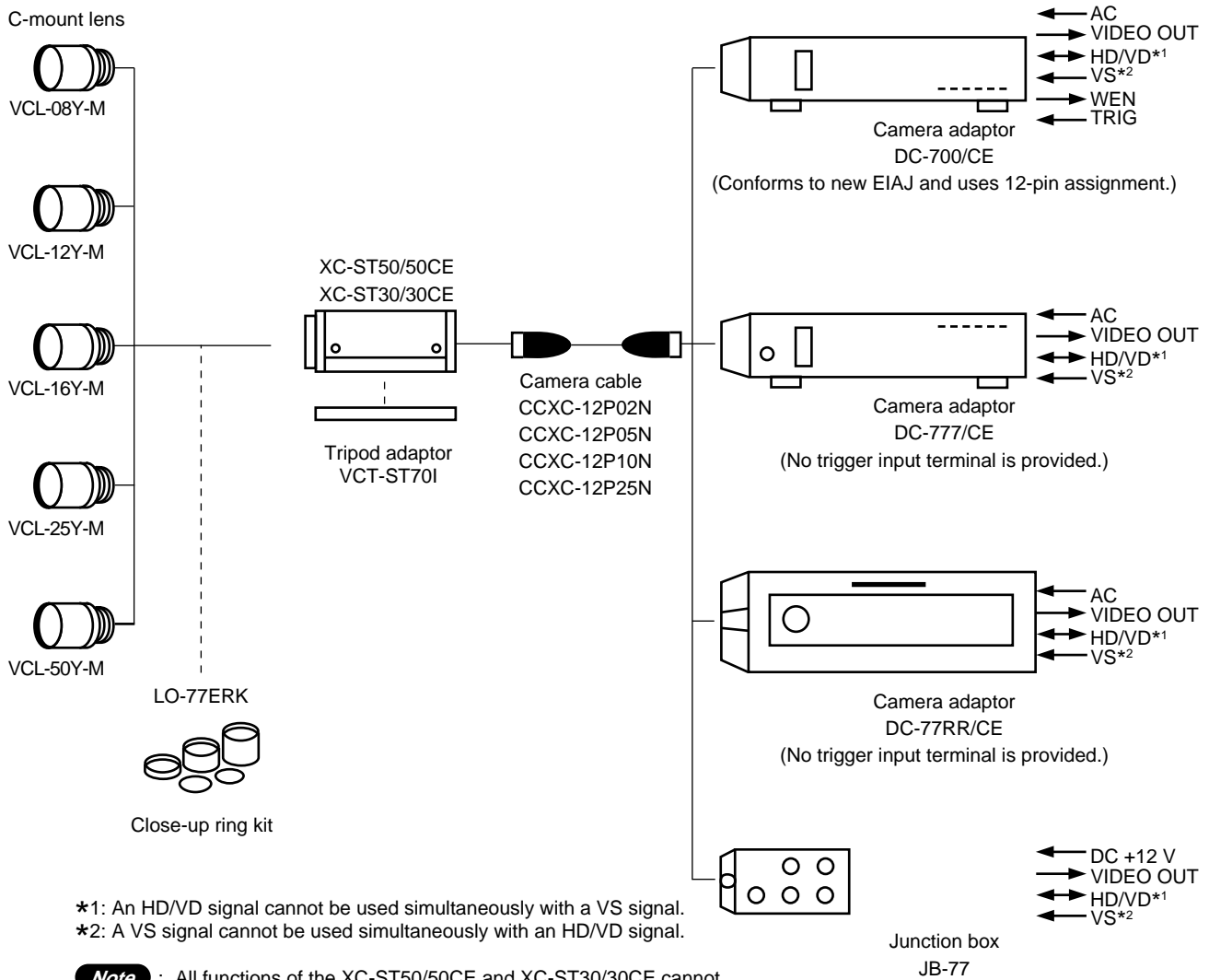

*1: An HD/VD signal cannot be used simultaneously with a VS signal.
*2: A VS signal cannot be used simultaneously with an HD/VD signal.

Note : All functions of the XC-ST50/50CE and XC-ST30/30CE cannot be used when using DC-777/CE, DC-77RR/CE, and JB-77. Refer to the table shown below.

XC-ST50/50CE XC-ST30/30CE	DC-777/CE	DC-77RR/CE	JB-77
Normal	○	○	○
Normal shutter	○	○	○
Restart Reset (R.R)	○	○	○
Restart Reset (R.R) + shutter	○	○	○
External trigger shutter	×	×	×

○: Can be used.
×: Cannot be used.

LOCATION OF PARTS AND OPERATION

XC-ST50/50CE XC-ST30/30CE

(XC-ST50 model)

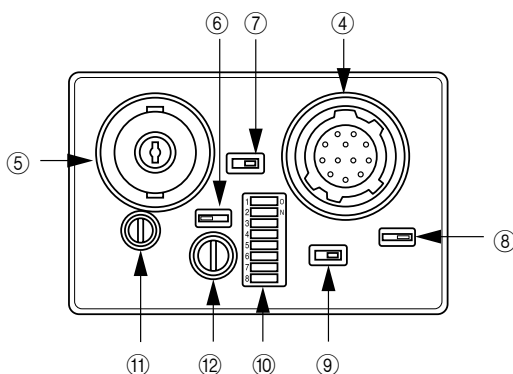
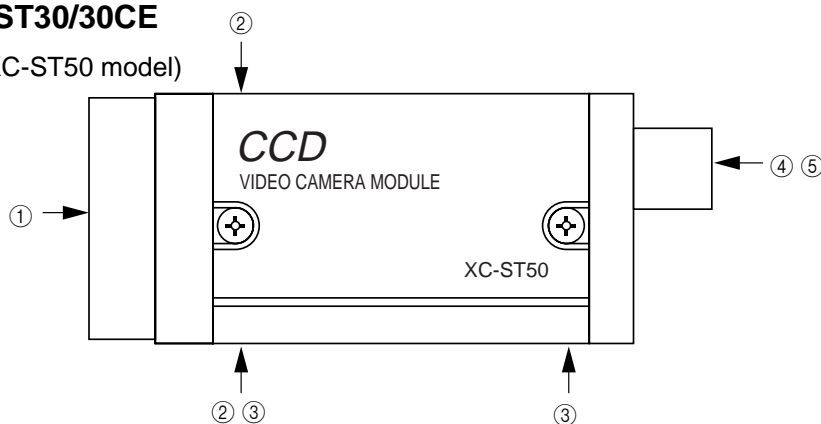

④ 12-pin multi-connector

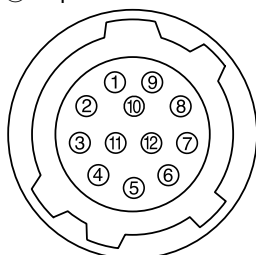

Pin No.	External HD/VD synchronization	Internal HD/VD synchronization	External VS synchronization
1	GND	GND	GND
2	+12 V	+12 V	+12 V
3	GND	GND	GND
4	VIDEO output	VIDEO output	VIDEO output
5	GND	GND	GND
6	External HD input	Internal HD output	-
7	*1 External VD input	Internal VD output	VS
8	GND	GND	GND
9	-	-	-
10	*2 WEN output	*2 WEN output	*2 WEN output
11	TRIG input	TRIG input	TRIG input
12	GND	GND	GND

*1: An input VD signal is required when the restart/reset mode is used.
*2: A WEN output signal is valid only in the external trigger shutter mode.

• Factory-setting mode of rear panel

Corresponding No.	Switch	Factory-setting mode
⑥	γ correction ON/OFF selector switch	OFF
⑦	Internal/external sync selector switch	EXT
⑧	Trigger polarity selector switch	+
⑨	75 Ω termination selector switch	ON
⑩	Selection DIP switch	
	1, 2, 3, 4: Selects the Shutter speed.	OFF (All set to the left.)
	5: Selects the field and frame integration.	
6, 7, 8: Selects the normal shutter, external trigger shutter, and restart/reset.		
⑪	GAIN switch	FIX

- ① Lens mount section
A commercial C-mount lens as well as a Sony standard lens can be used.
- ② Camera mounting reference hole
These screw holes are positioned with high precision related to CCD sensor.
- ③ Screw hole for tripod adaptor mounting (VCT-ST70I)
- ④ 12-pin multi-connector
DC IN/SYNC (DC power/sync signal input)
- ⑤ BNC connector
VIDEO OUT
- ⑥ γ correction ON/OFF selector switch
- ⑦ Internal/external sync selector switch
The camera operates with internal synchronization when there is no external sync input signal in the EXT position. In this case, an HD/VD signal is not output from the 12-pin multi-connector.
- ⑧ Trigger polarity selector switch
This switch can select the polarity (negative or positive) of a trigger pulse.
- ⑨ 75 Ω termination selector switch
- ⑩ Selection DIP switch
Switches 1 to 4:
Selects the shutter speed.
Switch 5: Selects the frame or field
Switches 6 to 8:
Selects the normal shutter, external trigger shutter, and restart/reset.
- ⑪ GAIN switch
A: Outputs a fixed-level video signal according to the brightness of a subject. (Variable range: 0 to 18 dB)
F: Fixed gain 0 dB
M: Variable gain (Manual)
M (during factory setting):
Adjusted so that all XC-ST50/50CEs or XC-ST30/30CEs are the same in sensitivity (set by Sony's standard value) according to the deviation in sensitivity of CCD.
Valid when multiple XC-ST50/50CEs or XC-ST30/30CEs are used for an identical subject.
- ⑫ Volume control switch
This switch can be changed in the range of 0 to 18 dB when the GAIN switch is set to "M".
During factory setting, this switch is adjusted to the fixed sensitivity for a standard subject.

PHASE CONDITIONS OF EXTERNAL SYNCHRONIZATION

External synchronization for each mode

- **For normal video/normal shutter**

Continuous HD/VD signal (should conform to EIA and CCIR frequencies in the timing shown in the figure below.)

- **For Restart Reset (RR)/external trigger shutter**

Continuous HD signal. The phase between VD (reset) and HD signals is as specified in the figure below in any timing.

Phase conditions

The phase relation between external input HD and VD signals should be set as shown below with respect to the specified center phase.

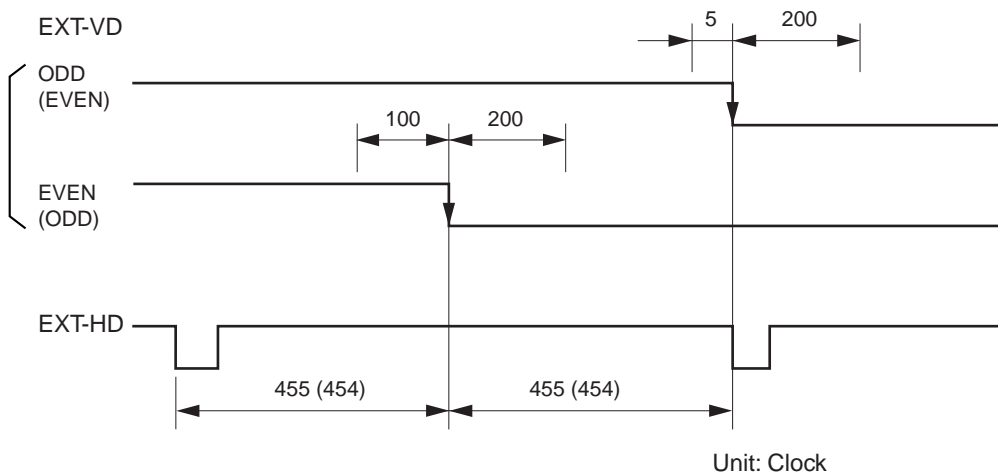

Unit: Clock

1 CLK = 69.84 n sec (XC-ST50/ST30)
= 70.48 n sec (XC-ST50CE/ST30CE)

The operation in parentheses refers to XC-ST50CE/ST30CE.

Note : The synchronized VD signals are delayed for 1H at HD/VD external synchronization mode, while there is no VD signal delay at VS external synchronization mode.

ELECTRONIC SHUTTER

Two types of electronic shutter are provided “normal shutter and external trigger shutter”.
The electronic shutter speed and type can be set using the DIP switch on the rear panel.

DIP switch on the rear panel

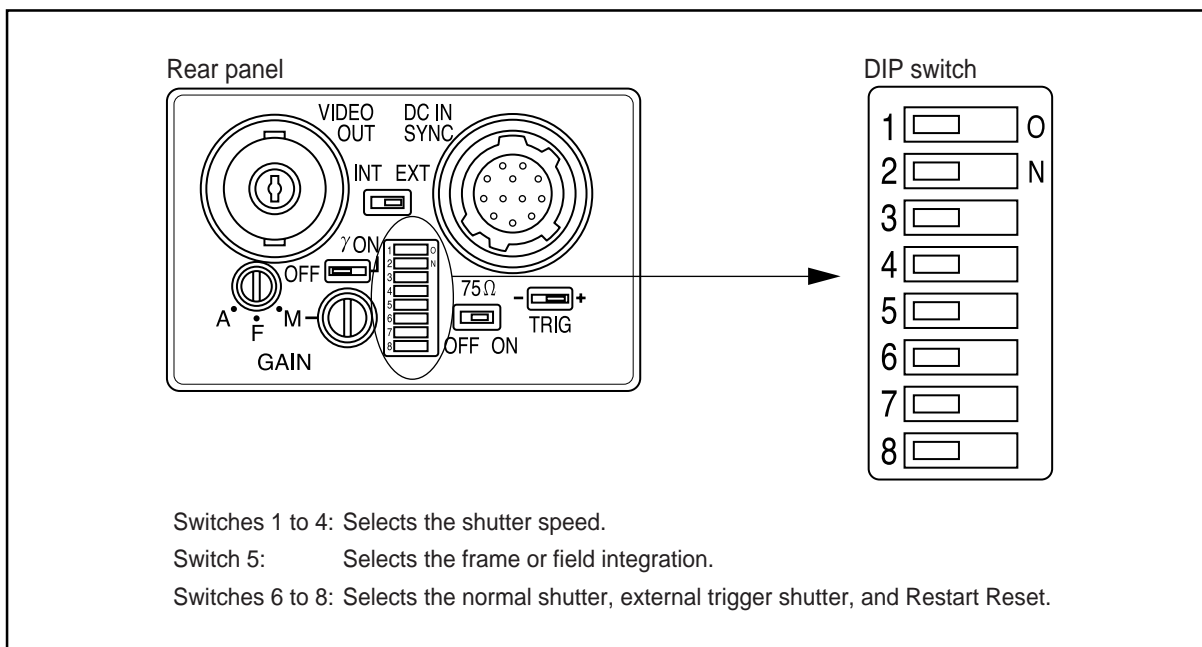

Normal shutter

This mode provides continuous video output with the electronic shutter selected by switches to clearly capture a high-speed moving object.

Setting of normal shutter speed

Switch	Shutter Off	1/125	1/250	1/500	1/1000	1/2000	1/4000	1/10000	*Flickerless
1	0	1	0	1	0	1	0	1	—
2	0	0	1	1	0	0	1	1	—
3	0	0	0	0	1	1	1	1	—
4	0	0	0	0	0	0	0	0	1
5	Frame: 0 / Field: 1								
6	—	—	—	—	—	—	—	—	—
7	—	—	—	—	—	—	—	—	—
8	—	—	—	—	—	—	—	—	—

* In the flickerless mode, the normal shutter speed is 1/100 sec for XC-ST50/ST30 (EIA) and 1/120 sec for

1: ON
0: OFF
—: Any

Note : It is recommended to set DIP switch 5 for field selection. (The field selection is about two times in sensitivity as high as the frame selection.)

ELECTRONIC SHUTTER

External trigger shutter

By inputting an external trigger, a high-speed moving subject can be caught at an exact position.
Set DIP switches 6, 7, and 8 on the rear panel to mode 1 or 2. (Refer to the table below.)
When the trigger pulse width is 1/3 sec or more, the output signal is switched to a normal video signal.

There are two modes for timing in which a video signal is obtained.

- **Mode 1 (Non-reset mode)**

In this mode, a video signal synchronized with a VD signal is output after a trigger pulse is input.

- A video signal is synchronized with the external VD signal when an external HD/VD signal is input.
- A video signal is synchronized with an internal VD signal when no external HD/VD signal is input.

- **Mode 2 (Reset mode)**

In this mode, a video signal is output from a trigger pulse after a certain period of time.

* For more details of each timing chart, refer to pages 16 to 23.

◇ Setting of external trigger shutter speed

There are two ways to set the shutter speed.

- **Using DIP switch on the rear panel**

Mode 1 (Non-reset mode)

Switch	*1/100	1/125	1/250	1/500	1/1000	1/2000	1/4000	**1/10000
1	–	1	0	1	0	1	0	1
2	–	0	1	1	0	0	1	1
3	–	0	0	0	1	1	1	1
4	1	0	0	0	0	0	0	0
5	Frame: 0 / Field: 1							
6	0	0	0	0	0	0	0	0
7	1	1	1	1	1	1	1	1
8	1	1	1	1	1	1	1	1

Mode 2 (Reset mode)

Switch	*1/100	1/125	1/250	1/500	1/1000	1/2000	1/4000	**1/10000
1	–	1	0	1	0	1	0	1
2	–	0	1	1	0	0	1	1
3	–	0	0	0	1	1	1	1
4	1	0	0	0	0	0	0	0
5	Frame: 0 / Field: 1							
6	0	0	0	0	0	0	0	0
7	0	0	0	0	0	0	0	0
8	1	1	1	1	1	1	1	1

* The external trigger shutter speed is set to 1/100 sec for XC-ST50/ST30(EIA) and 1/120 sec for XC-ST50CE/30CE(C CIR).

** The external trigger shutter speed is set to 1/10000 sec for XC-ST50/ST30(EIA) and 1/8000 sec for XC-ST50CE/30CE(C CIR).

1: ON
0: OFF
–: Any

- **Using trigger pulse width**

Set all of DIP switches 1 to 4 on the rear panel to 0.

- An arbitrary shutter speed can be obtained by setting the trigger pulse width to the range of 2 μsec to 250 msec.

Switch	Mode 1 (Non-reset mode)	Mode 2 (Reset mode)
1	0	0
2	0	0
3	0	0
4	0	0
5	Frame: 0 / Field: 1	
6	0	0
7	1	0
8	1	1

1: ON
0: OFF

Exposure time = Trigger pulse width + 97 μsec (XC-ST50/ST30)
120 μsec (XC-ST50CE/ST30CE)

Note : 1. It is recommended to set DIP switch 5 for field selection.
(The field selection is about two times in sensitivity as high as the frame selection.)
2. After a trigger pulse is input, a new trigger pulse must not be input before the video signal obtained by the trigger pulse has been output.

ELECTRONIC SHUTTER

◇ Specifications of trigger pulse

When using a trigger pulse like shown below, set the TRIG polarity selector switch on the rear panel to \oplus :

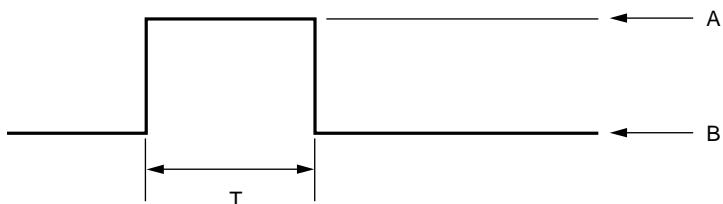

A: 2 to 5.0 V

B: 0 to 0.6 V

T: 2 μ s to 1/4 s, 100 μ s to 1/4 s when setting the shutter speed using DIP switch

When using a trigger pulse like shown below, set the TRIG polarity selector switch on the rear panel to \ominus :

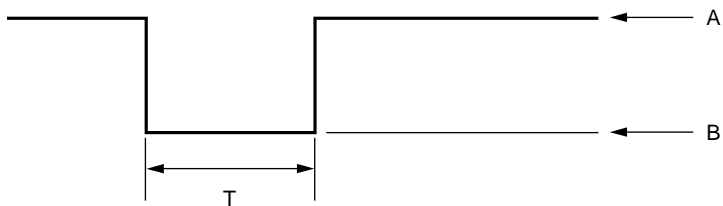

A: 4.0 to 5.0 V

B: 0 to 2.0 V

T: 2 μ s to 1/4 s, 100 μ s to 1/4 s when setting the shutter speed using DIP switch

- * Input impedance: 10 k Ω or more
- * The voltage and pulse width used are measured at pin 11 of a 12-pin multi-connector on the rear panel.

◇ Specifications of WEN (Write ENable Pulse)

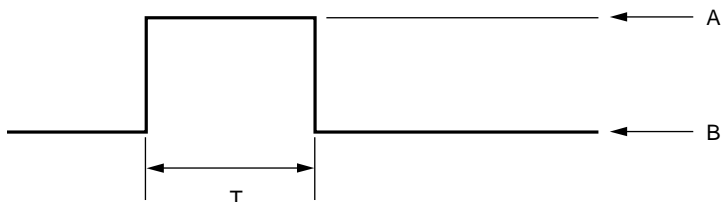

A: 5.0 V

B: 0 V

T: 15.875 ms (XC-ST50/30), 18.752 ms (XC-ST50CE/30CE)

- * Output impedance: 10 k Ω or more

RESTART RESET (R.R)

The information on one screen can be extracted at any time by inputting a restart/reset signal (HD/VD) from the outside. To enter this mode, set DIP switches 6, 7, and 8 on the rear panel of a camera as shown in the table below. The setting is especially effective for the following operation.

Switch	Restart Reset (R.R)
1	0
2	0
3	0
4	0
5	0
6	1
7	1
8	1

1: ON
0: OFF

◇ Long exposure

A high-sensitivity image is obtained by extending the exposure time of the CCD when satisfactory sensitivity cannot be obtained under ordinary operating conditions or when observing the trail of a moving object. The exposure time is determined by the VD interval (T) period between external VD pulses as follows.

• Timing and conditions

Example 1 of Long exposure

EXT HD Continuous signal: 15.734 kHz (XC-ST50/ST30), 15.625 kHz (XC-ST50CE/30CE) Allowable frequency value $\pm 1\%$



EXT VD VD interval(T): 262.5H or more (XC-ST50/ST30), 312.5H or more (XC-ST50CE/30CE) and 1 second or less (Recommended)
Four or more VD pulses are required.

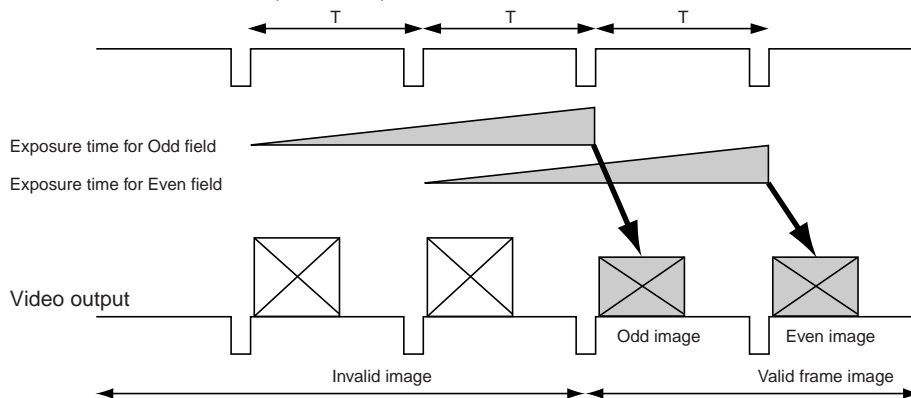

Odd and even fields are determined by the phase of the EXT HD/VD signal input from the outside.

RESTART RESET (R.R)

Example 2 of long exposure

EXT HD Continuous signal: 15.734 kHz (XC-ST50/ST30), 15.625 kHz (XC-ST50CE/30CE) Allowable frequency value $\pm 1\%$



EXT VD VD interval(T): 262.5H or more (XC-ST50/ST30), 312.5H or more (XC-ST50CE/30CE) and 1 second or less (Recommended)
Four or more VD pulses are required.

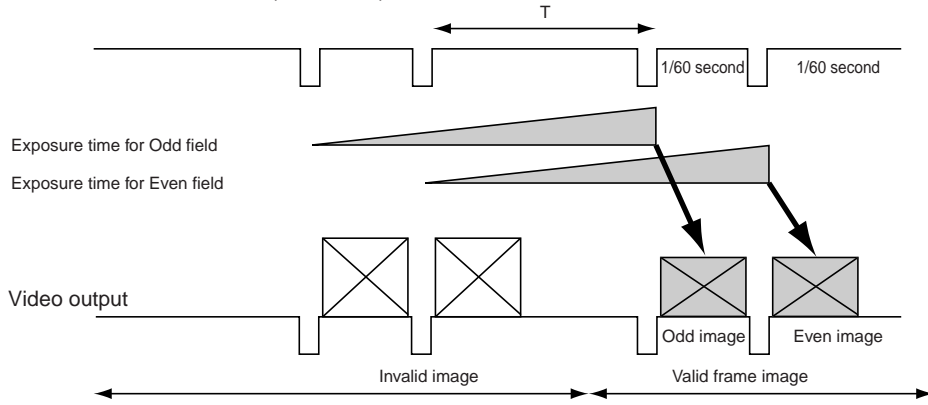

Odd and even fields are determined by the phase of the EXT HD/VD signal input from the outside.

FRAME IMAGE OUTPUT WITH STROBE LIGHT

A full frame image with vertical resolution of 485 lines (XC-ST50/ST30) or 575 lines (XC-ST50CE/ST30CE) can be obtained with a strobe light by firing the strobe when the exposure time of the two fields overlap.

- **Timing and conditions**

<Timing chart by restart/reset>

EXT HD Continuous signal: 15.734 kHz (XC-ST50/ST30), 15.625 kHz (XC-ST50CE/30CE) Allowable frequency value $\pm 1\%$

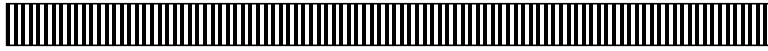

EXT VD VD: XC-ST50/ST30 (1/60 sec), XC-ST50CE/30CE (1/50 sec) Four or more VD pulses are required.

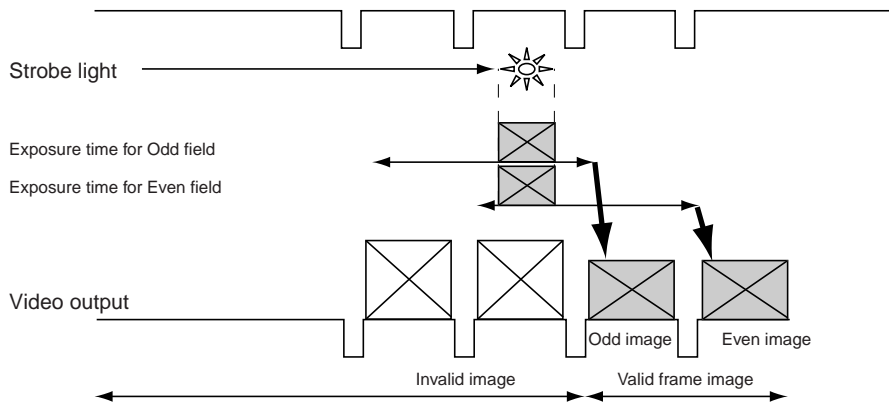

Odd and even fields are determined by the phase of the EXT HD/VD signal input from the outside.

Avoid lighting the scene during the light-emitting inhibit zone defined below. (The field is transferred to the storage area of the CCD, so it can be read out.)

Note : For best performance, it is recommended not to flash between VD and VD + 10H (XC-ST50/ST30)/ 16H (XC-ST50CE/ST30CE).

OUTPUT WAVEFORM TIMING CHART (XC-ST50 (EIA)/XC-ST30 (EIA))

◇ Timing chart of horizontal output waveform

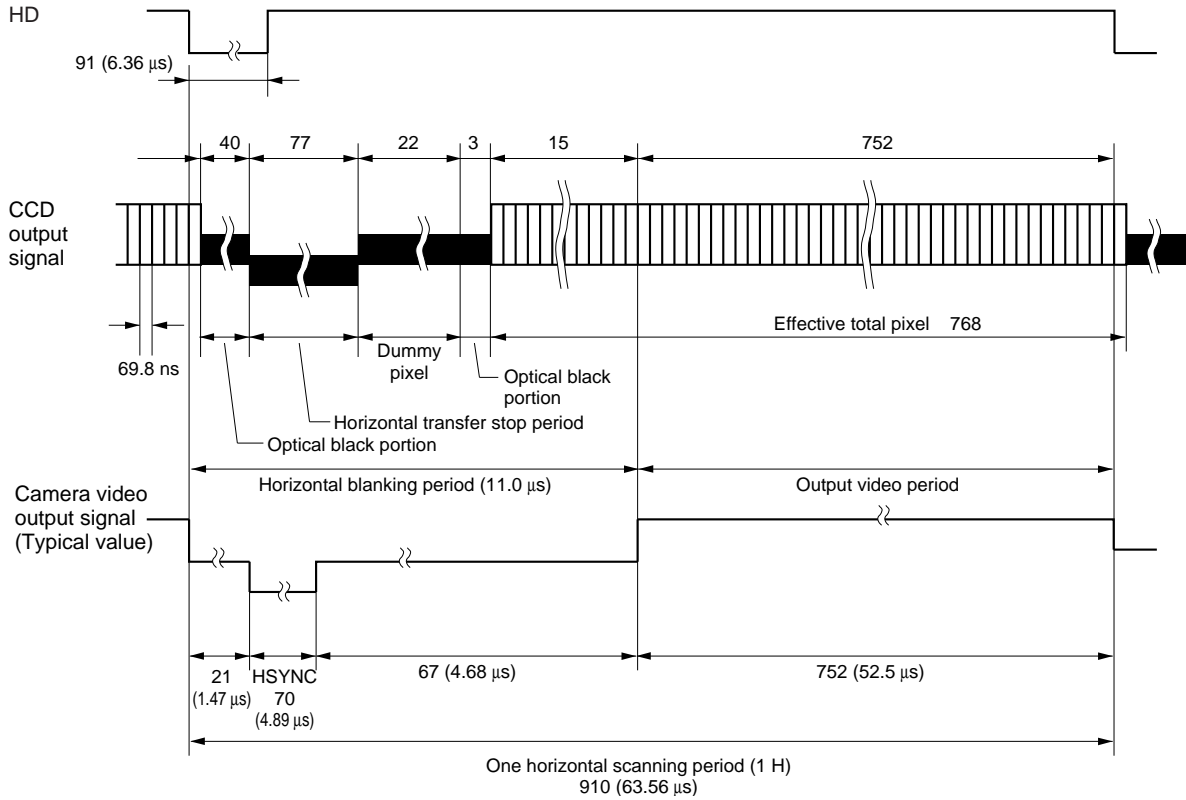

◇ Timing chart of vertical output waveform (2:1 interlaced frame integration)

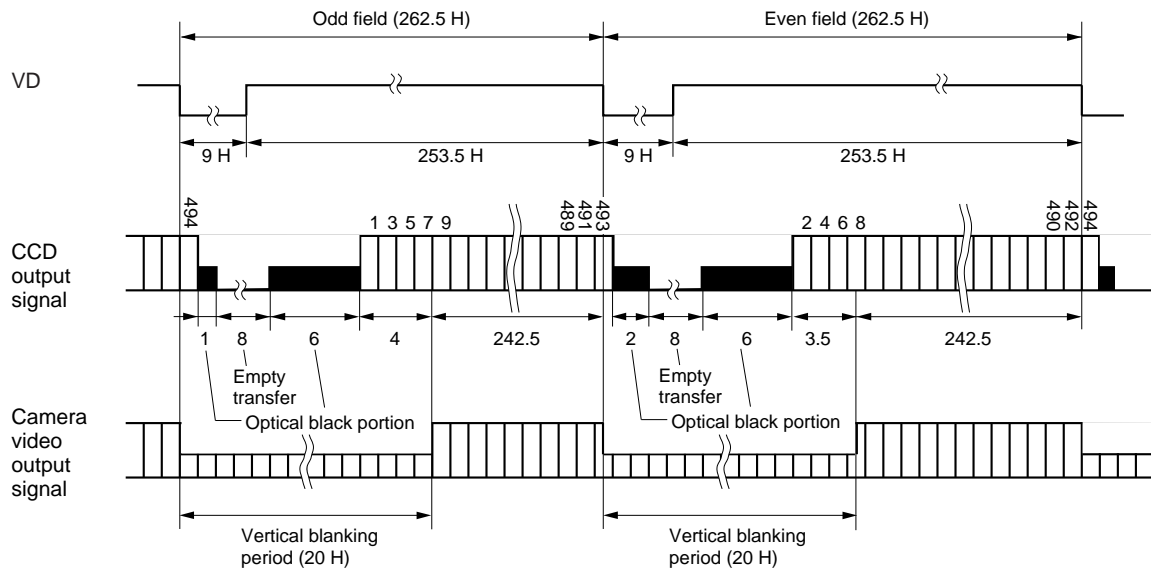

OUTPUT WAVEFORM TIMING CHART (XC-ST50 (EIA)/XC-ST30 (EIA))

◇ **Timing chart of vertical output waveform (2:1 interlaced field integration)**

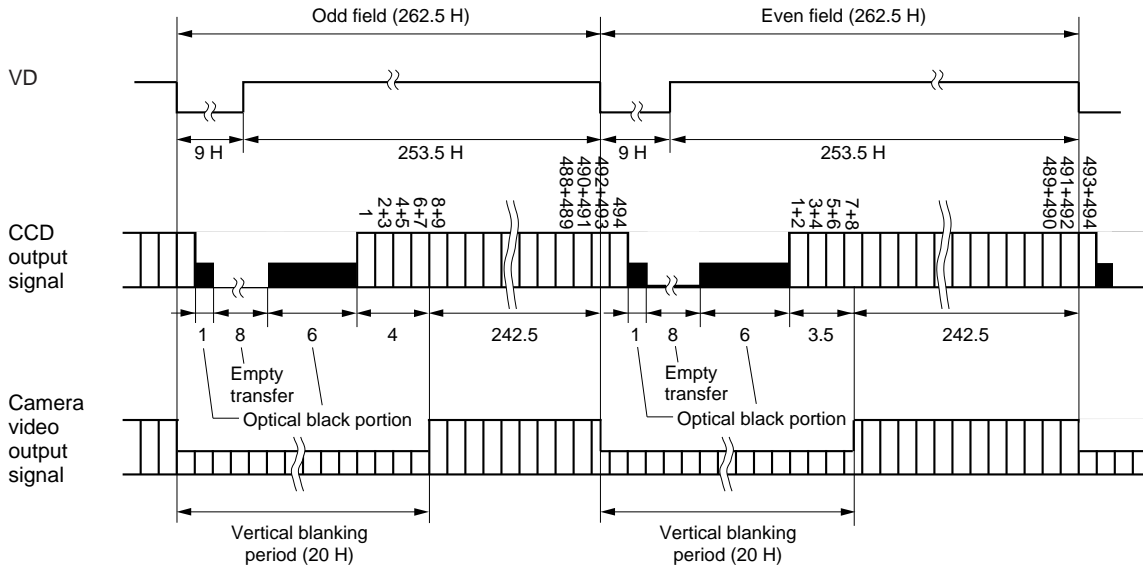

OUTPUT WAVEFORM TIMING CHART (XC-ST50CE (CCIR)/XC-ST30CE (CCIR))

◇ Timing chart of horizontal output waveform

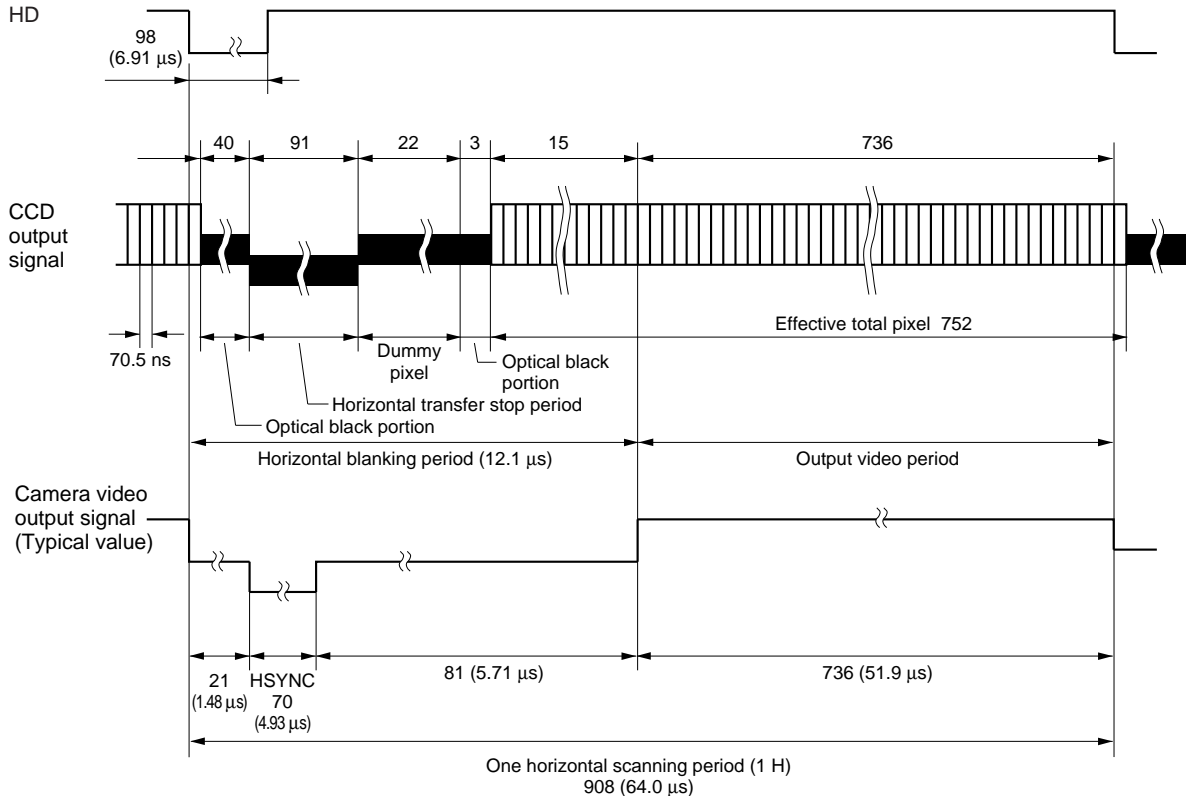

◇ Timing chart of vertical output waveform (2:1 interlaced frame integration)

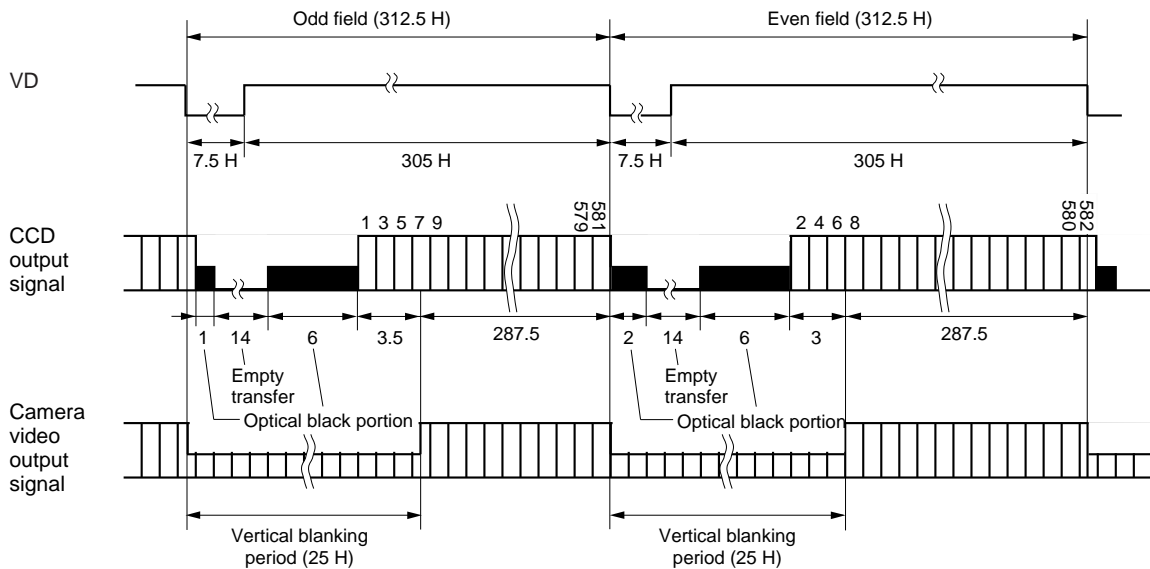

==== OUTPUT WAVEFORM TIMING CHART (XC-ST50CE (CCIR)/XC-ST30CE (CCIR)) ====

◇ Timing chart of vertical output waveform (2:1 interlaced field integration)

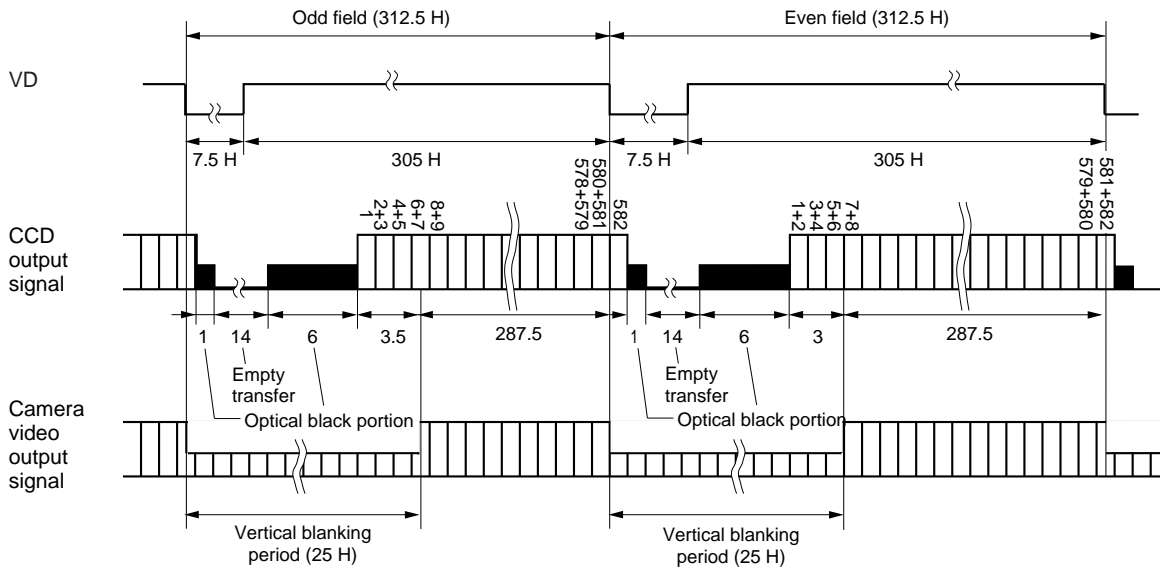

TIMING CHART OF EXTERNAL TRIGGER SHUTTER - MODE 1

(NON-RESET MODE)

For setting the shutter speed using TRG width

◇ HD/VD input

• Continuous HD/VD input

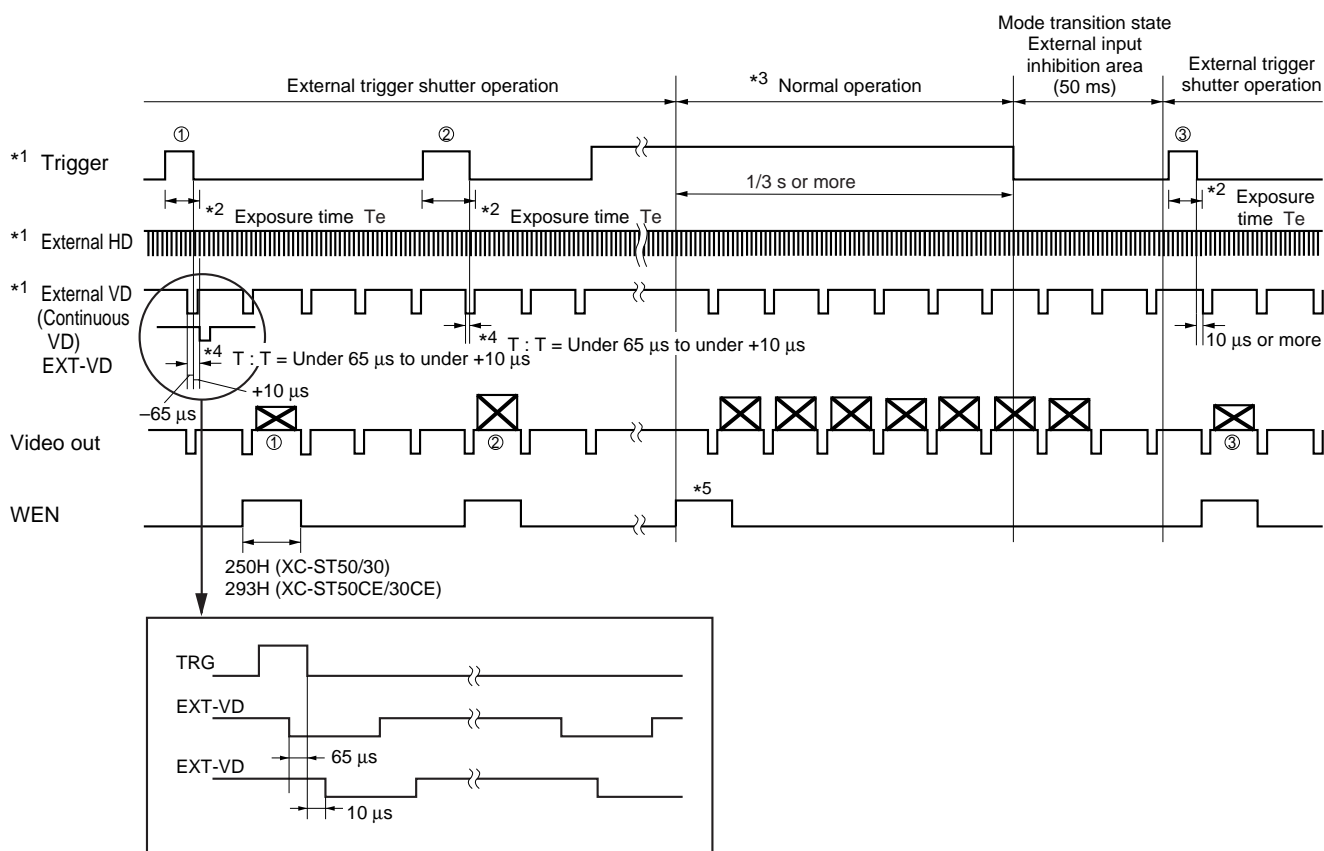

★1: This is a signal input from the outside. Be sure to input both HD and VD signals in this case.

★2: Exposure time T_e $T_e = \text{Trigger width} + 97 \mu\text{s}$ (XC-ST50/30)
 $T_e = \text{Trigger width} + 120 \mu\text{s}$ (XC-ST50CE/30CE)
 (The trigger width should be between $2 \mu\text{s}$ and $1/4 \text{ s}$)

★3: The normal operation state is engaged when the trigger high period exceeds $1/3 \text{ sec}$. The external trigger shutter operation is engaged when the trigger pulse goes "low". In this case, the area between the falling edge of a trigger pulse and the subsequent 50 ms period is an external trigger input inhibition area. During the trigger inhibit period, an input trigger may be missed.

★4: In all cases the WEN signal indicates when a valid image is available. Normally, an image is output after the external falling edge. If the falling edge of the trigger is very close to the falling edge of the external VD, there may be a delay of 1 VD in the output. The period of uncertainty is when the falling edge of VD is between $65 \mu\text{s}$ before or $10 \mu\text{s}$ after the falling edge of the trigger.

★5: When the external trigger shutter mode changes into the normal operation mode, one WEN signal is output.

Note : An image is superimposed when the next exposure ends before the previous image is output.

TIMING CHART OF EXTERNAL TRIGGER SHUTTER - MODE 1 (NON-RESET MODE)

For setting the shutter speed using TRG width

◇ HD/VD input

- Continuous HD input and single VD input

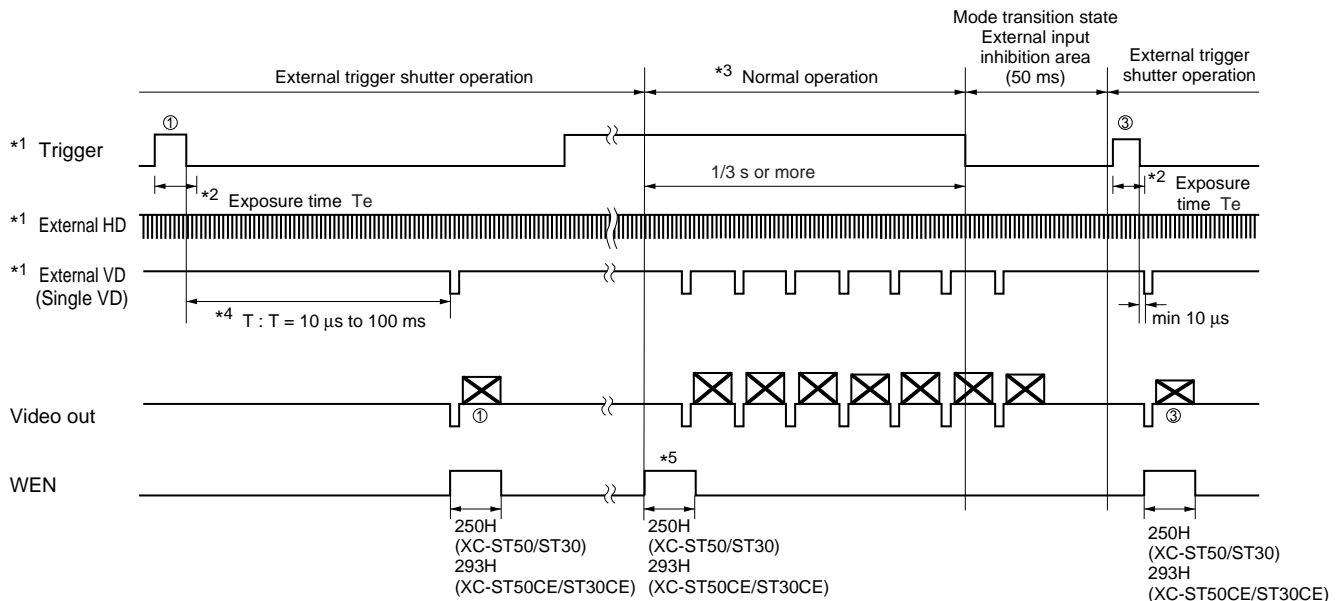

- *1: This is a signal input from the outside. Be sure to input both HD and VD signals in this case. Make the phase of the VD signal coincide with the falling edge of the HD signal during input operation.
- *2: Exposure time T_e
 - $T_e = \text{Trigger width} + 97 \mu\text{s}$ (XC-ST50/ST30)
 - $T_e = \text{Trigger width} + 120 \mu\text{s}$ (XC-ST50CE/ST30CE)
 (The trigger width should be between $2 \mu\text{s}$ and $1/4 \text{ s}$)
- *3: The normal operation state is engaged when the trigger high period exceeds $1/3 \text{ sec}$. After that the external trigger shutter operation is engaged when the trigger pulse goes "low". In this case, the area between the falling edge of a trigger pulse and the subsequent 50 ms period is an external trigger input inhibition area. During the trigger inhibit period, an input trigger may be missed.
- *4: Be sure to input an external VD signal between $10 \mu\text{s}$ and 100 ms from the falling edge of a trigger pulse (as shown by ① and ② in the figure). For the input (except described above), the operation cannot be ensured. If the external VD signal is not input under the prescribed conditions, the normal operation is engaged several V after a change in input operation under the prescribed conditions.
- *5: When the external trigger shutter mode changes into the normal operation mode, one WEN signal is output.

Note : An image is superimposed when the next exposure ends before the previous image is output.

TIMING CHART OF EXTERNAL TRIGGER SHUTTER - MODE 1 (NON-RESET MODE)

■ For setting the shutter speed using TRG width

◇ No HD/VD input (Internal synchronization)

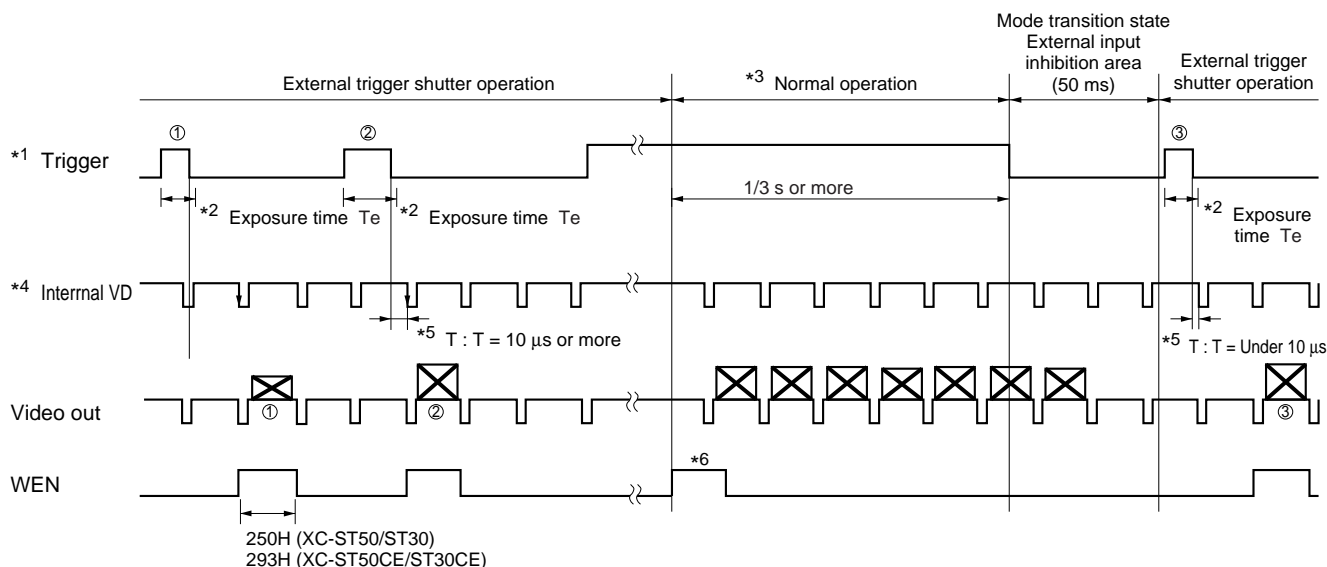

*1: This is a signal input from the outside.

*2: Exposure time T_e $T_e = \text{Trigger width} + 97 \mu\text{s}$ (XC-ST50/ST30)
 $T_e = \text{Trigger width} + 120 \mu\text{s}$ (XC-ST50CE/ST30CE)

*3: The normal operation state is engaged when the high period exceeds 1/3 sec. After that, the external trigger shutter operation is engaged when the trigger pulse goes "low". In this case, the area between the falling edge of a trigger pulse and the subsequent 50 ms period is an external input inhibition area. During the trigger inhibit period, an input trigger may be missed.

*4: An internal VD signal is output by setting the INT/EXT switch on the rear panel to INT.

*5: During external trigger shutter operation, an image is output when an internal VD signal falls after a trigger pulse falls (as shown by ① and ② in the figure). However, if the time (T in the figure) between the falling edges of a trigger pulse and internal VD signal is under $10 \mu\text{s}$, an image is output when the internal VD signal or the next internal VD signal falls (as shown by ③ in the figure). (In this case, an image is output when the next internal VD signal falls.) An image and WEN signal are always output together. For more details, refer to the WEN signal. (The falling edge of an internal VD signal is the same in phase as the beginning of an equalizing pulse in a SYNC V area.)

*6: When the external trigger shutter mode changes into the normal operation mode, one WEN signal is output.

Note : An image is superimposed when the next exposure ends before the previous image is output.

TIMING CHART OF EXTERNAL TRIGGER SHUTTER - MODE 1 (NON-RESET MODE)

For setting the shutter speed using DIP switch

◇ HD/VD input

• Continuous HD/VD input

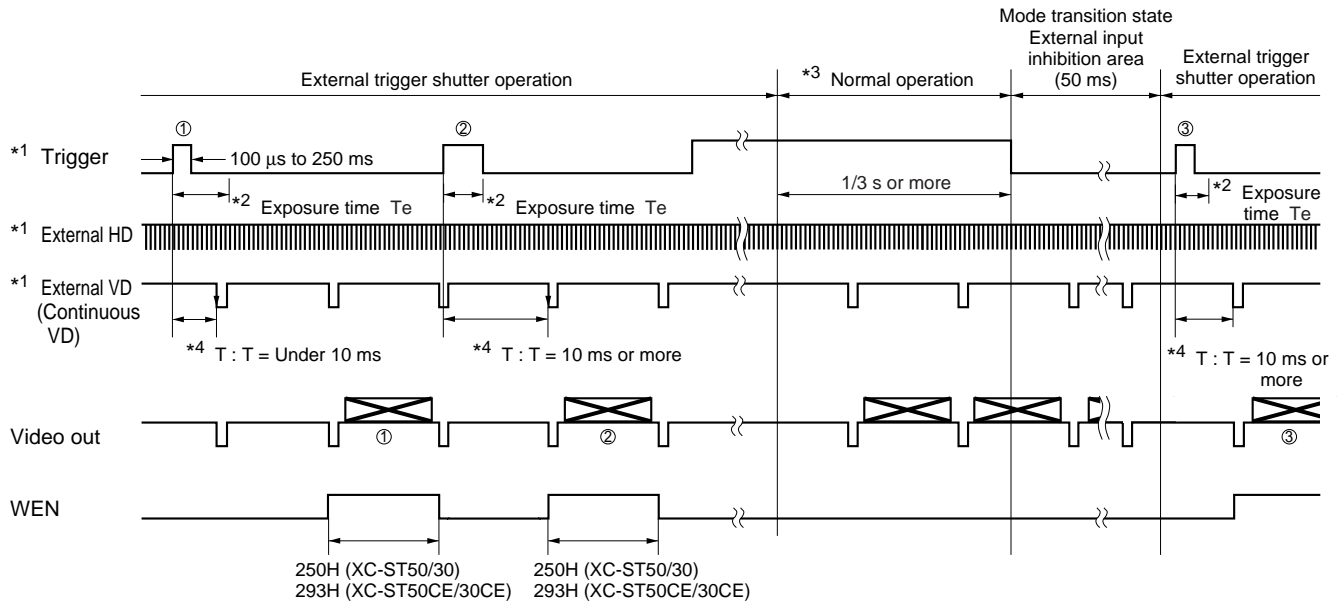

- *1: This is a signal input from the outside. The period of a continuous VD signal is prescribed as one field. Be sure to input both HD and VD signals.
- *2: As shown in the table on page 7, exposure time T_e is determined by the setting of a DIP switch.
- *3: The normal operation state is engaged when the high period exceeds 1/3 sec. After that, the external trigger shutter operation is engaged when the trigger pulse goes "low". In this case, the area between the falling edge of a trigger pulse and the subsequent 50 ms period is an external input inhibition area. During the trigger inhibit period, an input trigger may be missed.
- *4: An image is output when an external VD signal falls 10 ms or more after a trigger pulse rises (shown by ② and ③ in the figure). If the time (T in the figure) between the falling edges of a trigger pulse and external VD signal is under 10 ms, an image is output when the external VD signal or the next external VD signal falls (as shown by ① in the figure). (In this case, an image is output when the next external VD signal falls.) An image and WEN signal are always output together. For more details, refer to the WEN signal.

Note : An image is superimposed when the next exposure ends before the previous image is output.

TIMING CHART OF EXTERNAL TRIGGER SHUTTER - MODE 1 (NON-RESET MODE)

For setting the shutter speed using DIP switch

◇ HD/VD input

- Continuous HD input and single VD input

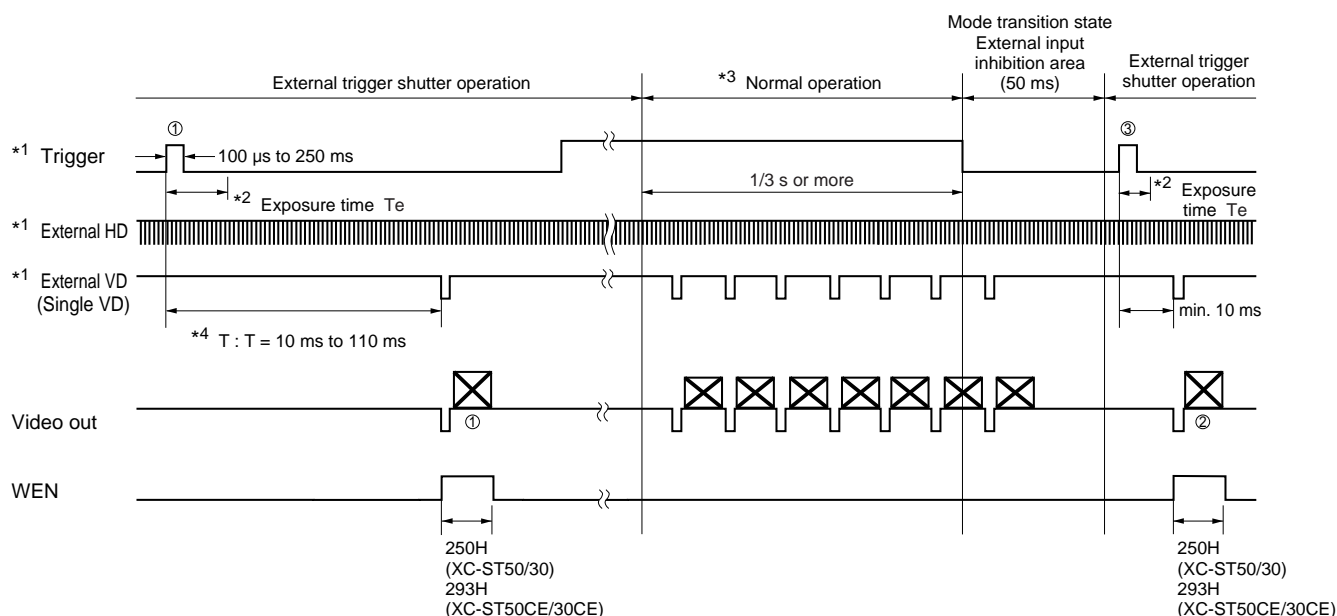

- *1: This is a signal input from the outside. Be sure to input both HD and VD signals. Make the phase of the VD signal coincide with the falling edge of the HD signal.
- *2: As shown in the table on page 7, exposure time T_e is determined by the setting of a DIP switch.
- *3: The normal operation state is engaged when the high period exceeds 1/3 sec. After that, the external trigger shutter operation is engaged when the trigger pulse goes "low". In this case, the area between the falling edge of a trigger pulse and the subsequent 50 ms period is an external input inhibition area. During the trigger inhibit period, an input trigger may be missed.
- *4: Be sure to input an external VD signal for 10 ms to 110 ms from the rising edge of a trigger pulse (as shown by ① and ② in the figure). For the input except described above, the operation cannot be ensured. If the external VD signal is not input under the prescribed conditions, the normal operation is engaged several V after a change in input operation under the prescribed conditions.

Note : An image is superimposed when the next exposure ends before the previous image is output.

TIMING CHART OF EXTERNAL TRIGGER SHUTTER - MODE 1 (NON-RESET MODE)

■ For setting the shutter speed using DIP switch

◇ No HD/VD input (Internal synchronization)

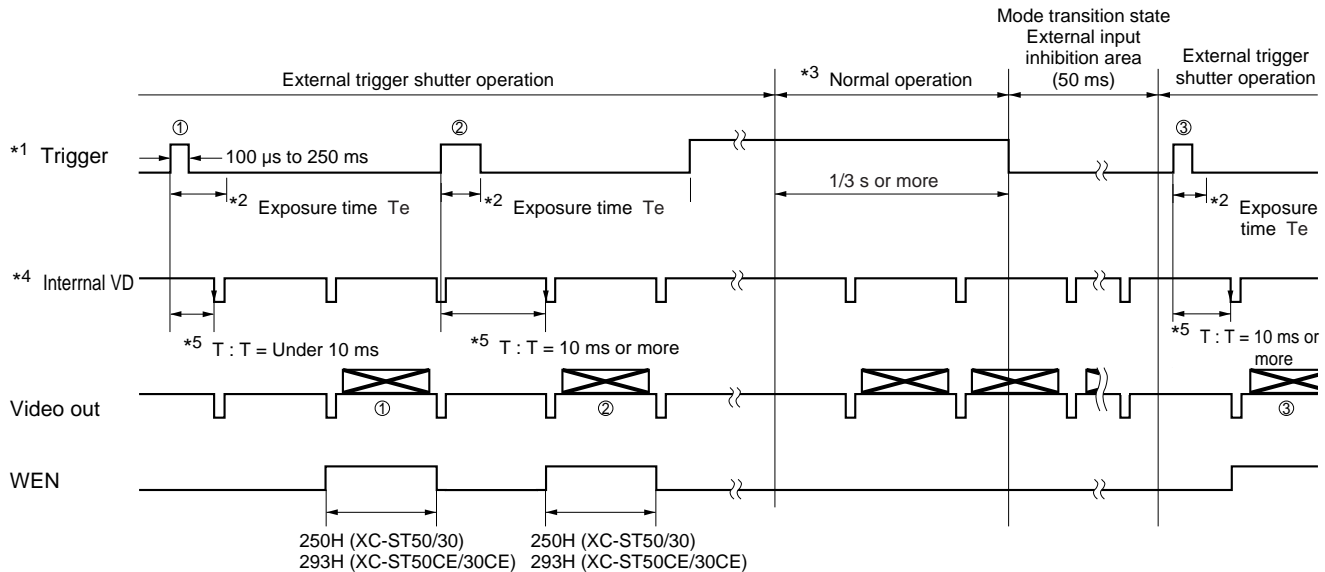

- *1: This is a signal input from the outside.
- *2: As shown in the table on page 7, exposure time T_e is determined by the setting of a DIP switch.
- *3: The normal operation state is engaged when the high period exceeds 1/3 sec. After that, the external trigger shutter operation is engaged when the trigger pulse goes "low". In this case, the area between the falling edge of a trigger pulse and the subsequent 50 ms period is an external input inhibition area. During the trigger inhibit period, an input trigger may be missed.
- *4: An internal VD signal is output by setting the INT/EXT switch on the rear panel to INT.
- *5: An image is output when an internal VD signal falls 10 ms or more after a trigger pulse rises (as shown by ② and ③ in the figure). If the time (T in the figure) between the falling edges of a trigger pulse and internal VD signal is under 10 ms, an image is output when the internal VD signal or the next internal VD signal falls (as shown by ① in the figure). In this case, an image is output when the next internal VD signal falls. An image and WEN signal are always output together. For more details, refer to the WEN signal. (The falling edge of an internal VD signal is the same in phase as the beginning of an equalizing pulse in a SYNC V area.)

Note : An image is superimposed when the next exposure ends before the previous image is output.

TIMING CHART OF EXTERNAL TRIGGER SHUTTER - MODE 2 (RESET MODE)

■ For setting the shutter speed using TRG width

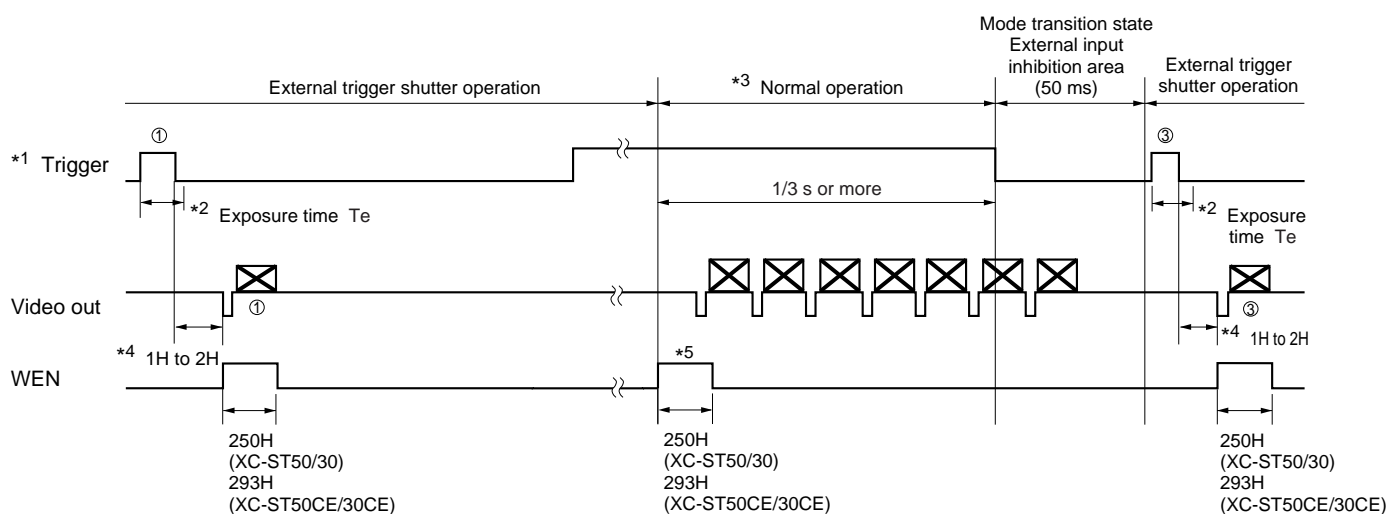

- ★1: This is a signal input from the outside. The trigger interval should be trigger pulse width + 1 field + 2H period or more. The trigger interval shorter than described above cannot be ensured. If a trigger pulse is not input under the prescribed conditions, the normal operation is ensured several V after a change in input operation under the prescribed conditions.
- ★2: Exposure time T_e $T_e = \text{Trigger width} + 97 \mu\text{s}$ (XC-ST50/ST30),
 $T_e = \text{Trigger width} + 120 \mu\text{s}$ (XC-ST50CE/ST30CE)
 (The trigger width should be between 2 μs and 1/4 s)
- ★3: The normal operation state is engaged when the high period exceeds 1/3 sec. After that, the external trigger shutter operation is engaged when the trigger pulse goes "low". In this case, the area between the falling edge of a trigger pulse and the subsequent 50 ms period is an external input inhibition area. During the trigger inhibit period, an input trigger may be missed.
- ★4: A VD signal is generated 1H to 2H after a trigger pulse falls, and an image is output in synchronization with the VD signal.
- ★5: When the external trigger shutter mode changes into the normal operation mode, a WEN signal is output.

TIMING CHART OF EXTERNAL TRIGGER SHUTTER - MODE 2 (RESET MODE)

■ For setting the shutter speed using DIP switch

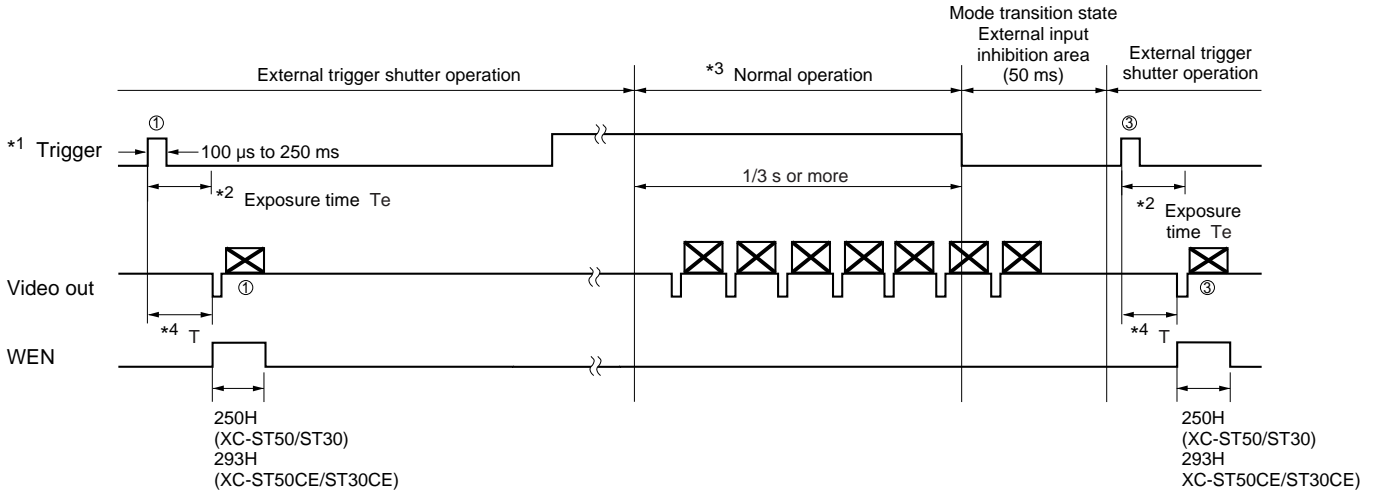

- *1: This is a signal input from the outside. The trigger interval should be shutter speed (DIP switch) + 1 field + 2H period or more. The trigger interval shorter than described above cannot be ensured. If a trigger pulse is not input under the prescribed conditions, the normal operation is engaged several V after a change in input operation under the prescribed conditions.
- *2: As shown in the table on page 7, exposure time T_e is determined by the setting of a DIP switch.
- *3: The normal operation state is engaged when the high period exceeds 1/3 sec. After that, the external trigger shutter operation is engaged when the trigger pulse goes "low". In this case, the area between the falling edge of a trigger pulse and the subsequent 50 ms period is an external input inhibition area. During the trigger inhibit period, an input trigger may be missed.
- *4: After a period set by a DIP switch from the rising edge of the trigger, an image is output.

DIMENSIONS

XC-ST50/50CE XC-ST30/30CE

(XC-ST50 model)

(Unit: mm)

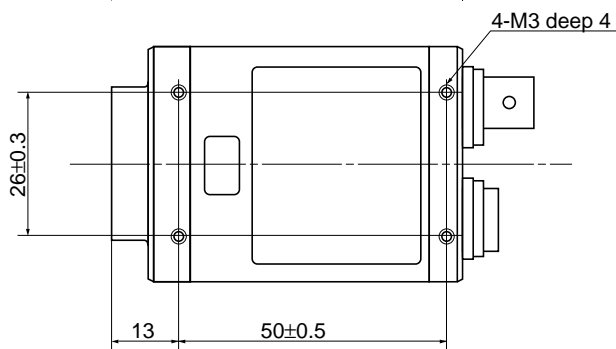
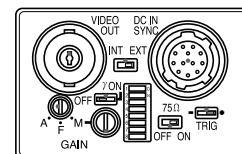
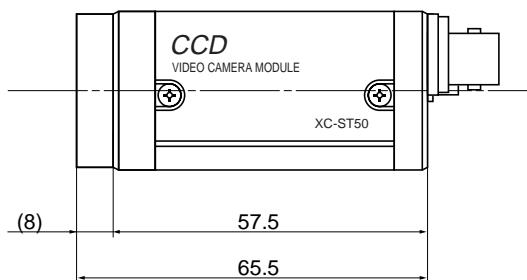
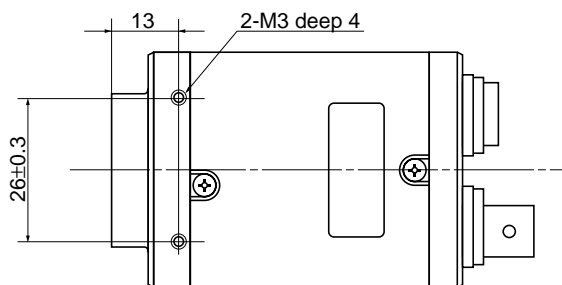
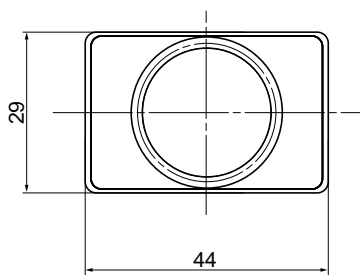

SPECTRAL RESPONSE CHARACTERISTICS (TYPICAL VALUE)

XC-ST50/ST30

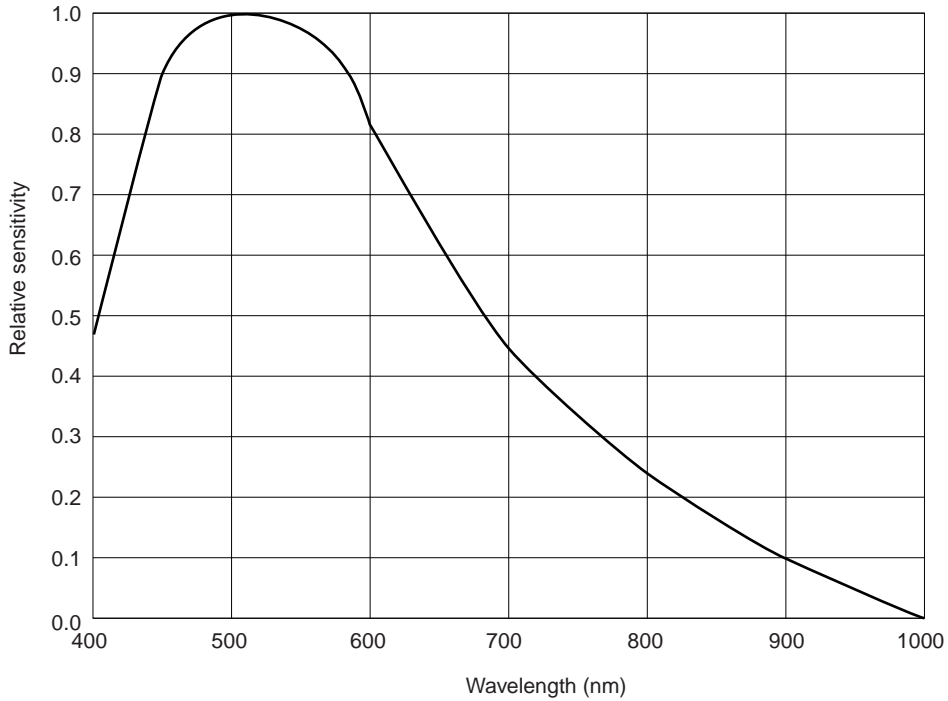

COMPARISON OF SPECTRAL RESPONSE CHARACTERISTICS (TYPICAL VALUE)

XC-75/73 and XC-ST50/ST30

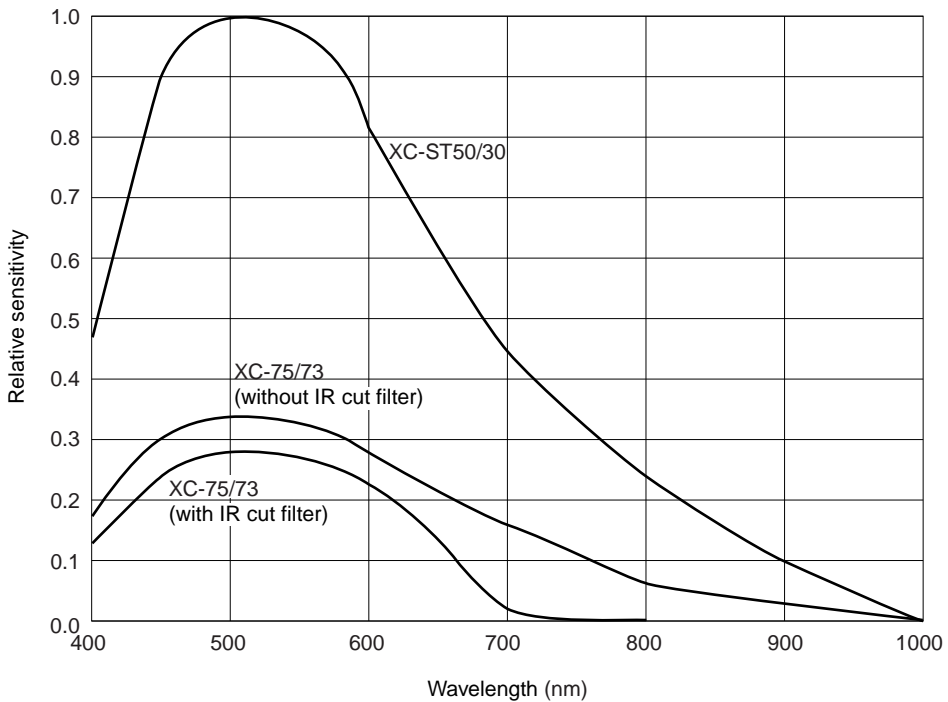

VARIOUS LENS SELECTION

The following shows the various lens specifications of the accessories available.

XC-ST50/50CE and XC-ST30/30CE compatibility

List of C-Mount Lens

Model name		VLC-08YM	VLC-12YM	VLC-16Y-M	VLC-25Y-M	VLC-50Y-M
Focal distance (mm)		8	12	16	25	50
Maximum aperture ratio		1: 1.4	1: 1.8	1: 1.4	1: 1.6	1: 2.8
Operation	Iris	Manual	Manual	Manual	Manual	Manual
	Focus	Manual	Manual	Manual	Manual	Manual
Field angle (Horizontal x vertical)	1/2" CCD	42.6°×32.6°	29.6°×22.4°	22.6°×17.0°	14.6°×11.0°	7.3°×5.5°
	1/3" CCD	32.6°×24.8°	22.4°×16.9°	17.0°×12.8°	11.0°×8.2°	5.5°×4.1°
MOD (mm)		207	208	289	204	438
Image pickup range during maximum proximity (horizontal × vertical) (mm)	XC-ST50	181×132.8	125.2×92.1	119.4×88.5	52.1×38.8	49.2×37
	XC-ST50CE	181.3×133.3	125.5×92.5	119.6×88.8	52.1×38.9	49.7×37.1
	XC-ST30	136.8×100	94.7×69.6	90×66.8	39.4×29.3	37.2×27.9
	XC-ST30CE	137×100.3	94.8×69.6	90.4×66.9	39.4×29.3	37.5×27.9
Back focus (mm)		11.54	10.99	12.5	11.6	22.1
Flange back (mm)		17.526	17.526	17.526	17.526	17.526
Mass (g)		40	40	50	42	50

MOD: Minimum object distance between the tip of the lens body and the object

Sony reserves the right to change specifications of the products and discontinue products without notice.
Technical information contained herein is for reference only and does not convey any license by any implication or otherwise under any intellectual property right or other right of Sony or third parties.
Sony cannot assume responsibility for any right infringements arising out of the use of this information.

Sales Office :

XC-ST50/50CE
XC-ST30/30CE

Japan

<http://www.sony.co.jp/ISP/>

Sony Corporation

4-14-1 Asahi-cho, Atsugi-shi, Kanagawa, 243-0014 Japan

Tel: +81-46-227-2346 Fax: +81-46-227-2347

Tel: +81-46-230-5873 Fax: +81-46-230-6243

USA

<http://www.sony.com/professional>

Sony Electronics Inc.

HQ

1 Sony Drive Park Ridge, NJ 07656

Tel: +1-800-686-7669

Canada

Sony of Canada Ltd.

115 Gordon Baker Rd, Toronto, Ontario M2H 3R6

Tel: +1-416-499-1414 Fax: +1-416-497-1774



Europe

<http://www.pro.sony-europe.com/ISP>

Sony Broadcast & Professional

HQ

15, rue Floreal 75831 Paris Cedex 17, France

Tel: +33-1-55-90-35-11 Fax: +33-1-55-90-35-17

Germany

Hugo-Eckener-Str. 20, 50829 Koln

Tel: +49-221-5966-322 Fax: +49-221-5966-491

France

15, rue Floreal 75831 Paris Cedex 17

Tel: +33-1-55-90-41-62 Fax: +33-1-55-90-13-57

UK

The Heights, Brooklands, Weybridge, Surrey KT13 0XW

Tel: +44-1932-816-340 Fax: +44-1932-817011

Nordic

Per Albin Hanssons vag 20 S-214 32 Malmo Sweden

Tel: +46-40-190-800 Fax: +46-40-190-450

Italy

Via Galileo Galilei 40 I-20092 Cinisello Balsamo, Milano

Tel: +39-02-618-38-431 Fax: +39-02-618-38-402