

*RoHS COMPLIANT

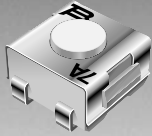

BOURNS®

Features

- Compatible with most surface mount soldering processes
- Compatible with popular vacuum pick-and-place equipment
- J-hook, gull-wing & pinned configurations
- Sealed for board washing
- Meets EIA/EIAJ/IPC/VRCI SMD standard outline dimensions
- Top or side actuated
- RoHS compliant *

7914 4 mm SMD & Through-hole Sealed Key Switch

Electrical Characteristics

Contact Rating
 Maximum Current100 mA max.
 Maximum Voltage16 V
 Contact Resistance100 milliohms max.
 Insulation Resistance ...100 megohms min.
 Dielectric Strength250 VAC

General Characteristics

Switch TypeNormally open
 Operating Temperature Range
-55 °C to +125 °C
 Storage Temperature Range
-55 °C to +125 °C
 Seal Test85 °C Fluorinert†
 Vibration20 G
 Shock100 G

Mechanical Characteristics

Actuator Force300 ± 100 g
 Pushover Strength (S Style)
2 kilograms minimum
 Cycle life, loaded100,000 actuations
 Contact resistance100 milliohms max.

Physical Characteristics

Cover MaterialStainless steel
 Base MaterialThermoplastic, UL94V-0
 Terminal MaterialPhosphor bronze
 Dome MaterialStainless steel
 Actuator MaterialHigh temperature
 silicon rubber
 MarkingManufacturer's code
 and date code

Packaging Options

J & G500 pcs./reel; 50 pcs./tube
 S200 pcs./reel; 100 pcs./tube
 H50 pcs./tube

How to Order

7914 J - 1 - 000 E

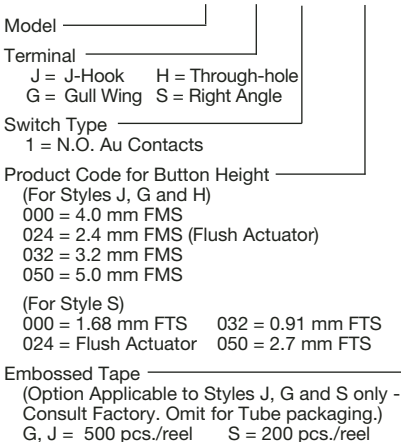

FMS = From Mounting Surface
 FTS = From Top Surface

Product Dimensions

7914J J-Hook

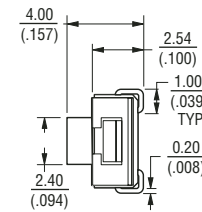
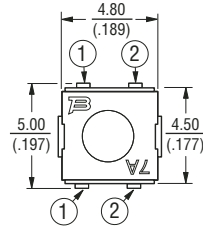

RECOMMENDED PCB LAYOUT

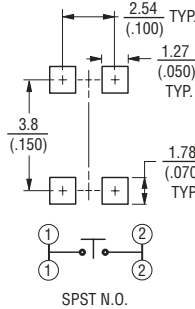

7914H Through-hole

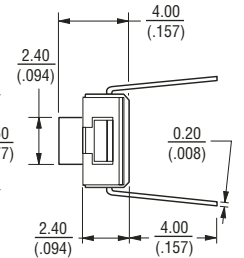
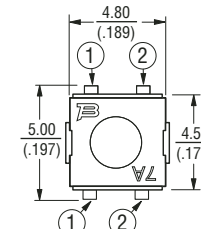

RECOMMENDED PCB LAYOUT

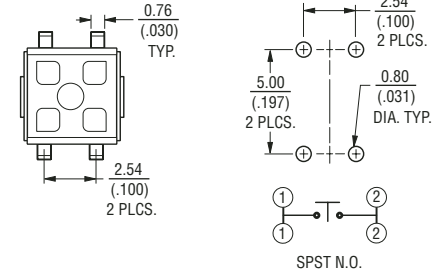

7914G Gull Wing

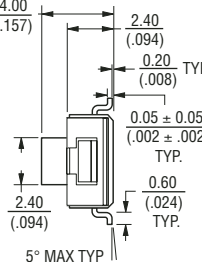
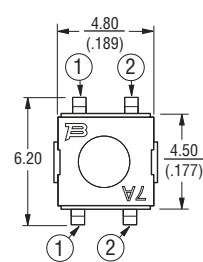

RECOMMENDED PCB LAYOUT

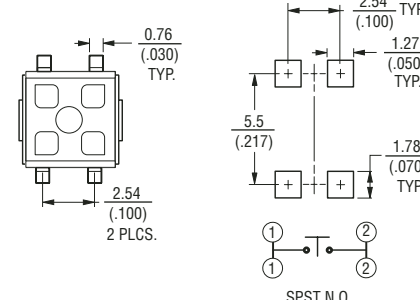

7914S Right Angle

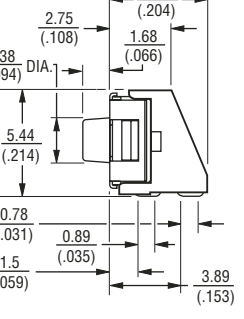
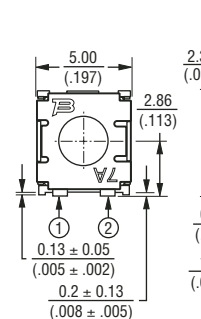

RECOMMENDED PCB LAYOUT

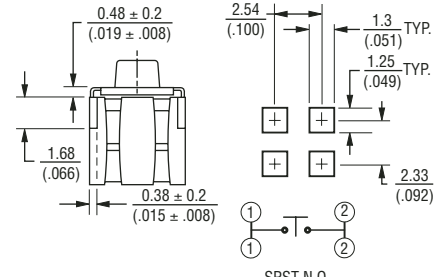

DIMENSIONS : $\frac{\text{MM}}{\text{(INCHES)}}$

TOLERANCES : $\frac{0.2}{(.008)}$
 EXCEPT WHERE NOTED.

*RoHS Directive 2002/95/EC Jan 27 2003 including Annex.
 †"Fluorinert" is a registered trademark of 3M Co.
 Specifications are subject to change without notice.
 Customers should verify actual device performance in their specific applications.

7914 4 mm SMD & Through-hole Sealed Key Switch

BOURNS®

Packaging Specifications

7914J

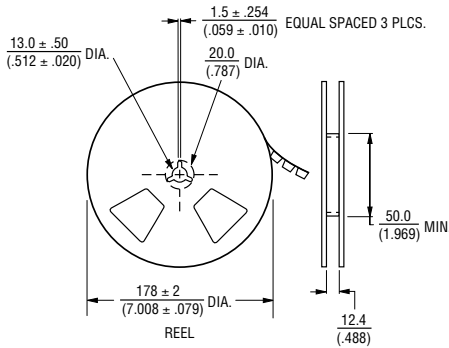
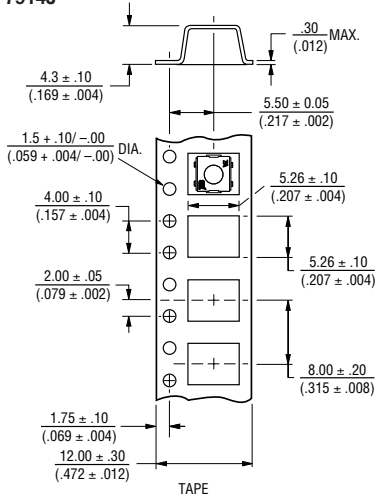

Meets EIA specification 481.

500 pcs./reel

7914J/G

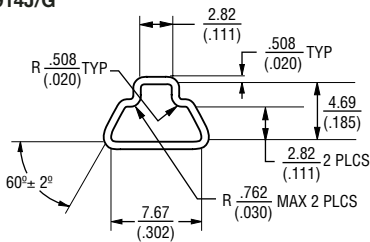

50 pcs./tube

7914G

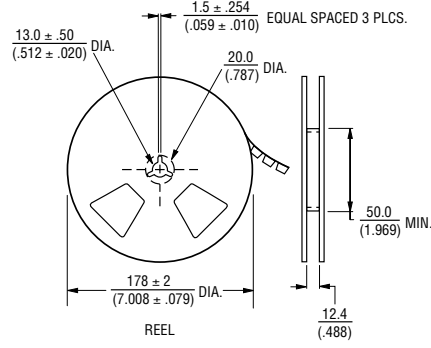
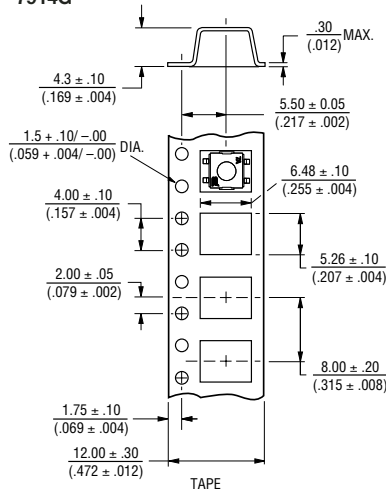

Meets EIA specification 481.

500 pcs./reel

7914H

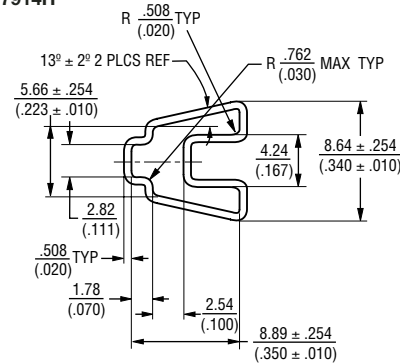

50 pcs./tube

7914S

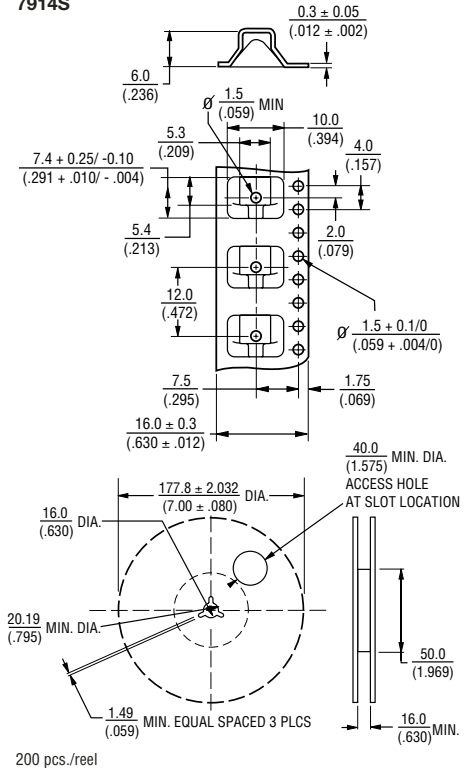

7914S

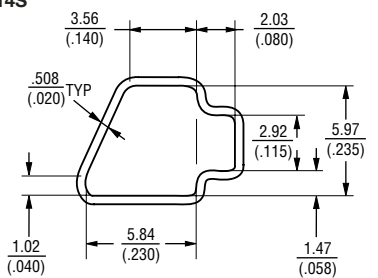

100 pcs./tube

Reflow Soldering Profile

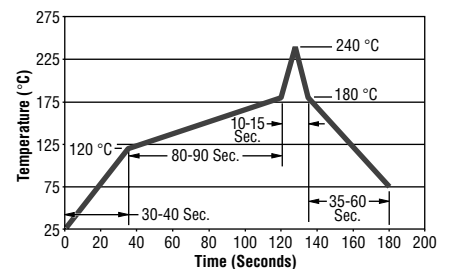

REV. 04/06

Specifications are subject to change without notice. Customers should verify actual device performance in their specific applications.