



# LTS-5000A LTD-5000A SERIES

0.56" SEVEN-SEGMENT NUMERIC DISPLAYS

## FEATURES

- 0.56 INCH (14.2mm) DIGIT HEIGHT.
- CONTINUOUS UNIFORM SEGMENTS.
- CHOICE OF FIVE BRIGHT COLOR-RED/BRIGHT RED/GREEN/YELLOW/ORANGE.
- LOW POWER REQUIREMENT.
- EXCELLENT CHARACTERS APPEARANCE.
- HIGH CONTRAST.
- HIGH BRIGHTNESS.
- WIDE VIEWING ANGLE.
- SOLID STATE RELIABILITY.
- CATEGORIZED FOR LUMINOUS INTENSITY.
- I.C. COMPATIBLE.
- EASY MOUNTING ON P.C. BOARD OR SOCKETS.

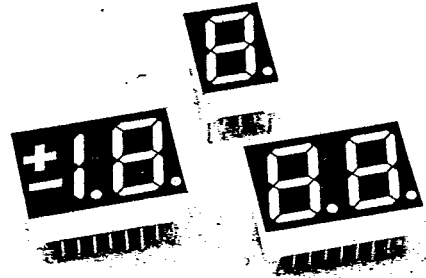

## DESCRIPTION

The LTS-5000A/LTD-5000A series are 0.56 inch (14.2mm) height single and dual digit displays.

The red series devices utilize LED chips which are made from GaAsP on GaAs substrate. The bright red and green series utilize LED chips which are made from GaP on a transparent GaP substrate. The yellow, orange series devices utilize LED chips which are made from GaAsP on a transparent GaP substrate. Red, bright red, yellow and orange displays have gray face and white segment color. Green displays have gray face and green segment color.

## DEVICES

PART NO.					DESCRIPTION	PACKAGE DIMENSION	INTERNAL CIRCUIT DIAGRAM
RED	BRIGHT RED	GREEN	YELLOW	ORANGE			
LTS-5301AR	5301AP	5601AG	5701AY	5501AE	Common Anode, Rt. Hand Decimal	A	A
LTS-5303AR	5303AP	5603AG	5703AY	5503AE	Common Cathode, Rt. Hand Decimal	A	B
LTD-5321AR	5321AP	5621AG	5721AY	5521AE	Common Anode, R. H. Decimal	B	C
LTD-5323AR	5323AP	5623AG	5723AY	5523AE	Common Cathode, R. H. Decimal	B	D
LTD-5327AR	5327AP	5627AG	5727AY	5527AE	Common Anode, R. H. Decimal	B	E
LTD-5328AR	5328AP	5628AG	5728AY	5528AE	Common Cathode, R. H. Decimal	B	F

# PACKAGE DIMENSION

www.DataSheet4U.com

## A. LTS-5x01A/5x03A

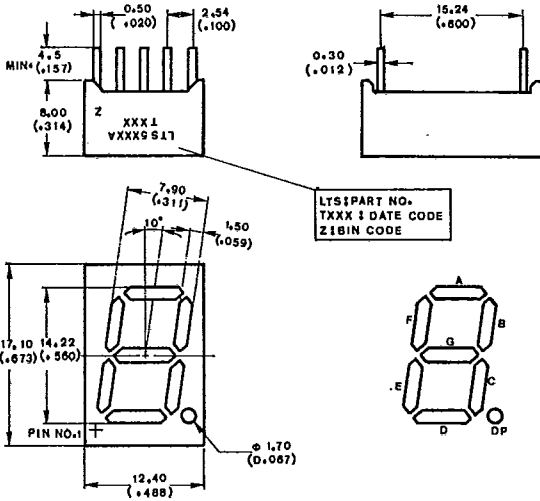

## B. LTD-5x21A/5x23A/5x27A/5x28A

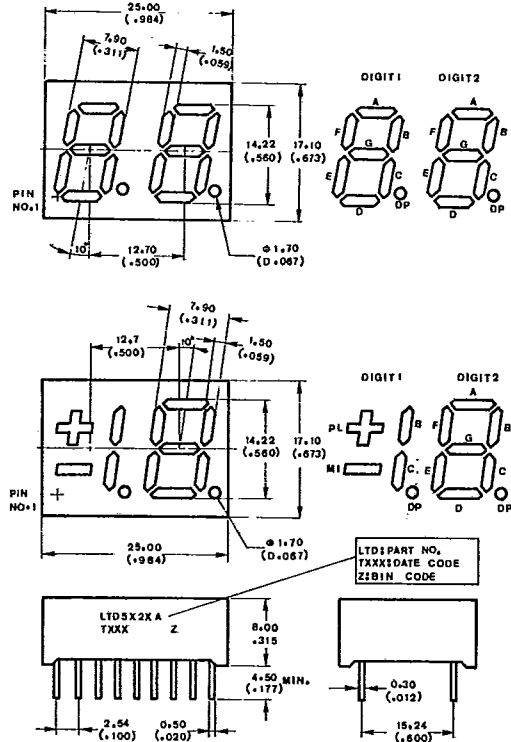

NOTE: All dimensions are in  $\frac{\text{millimeters}}{\text{(inches)}}$ , tolerance is  $\frac{0.25\text{mm}}{(0.010'')}$  unless otherwise noted.

## PIN CONNECTION

PIN NO.	CONNECTION			
	A. LTS-5x01A	B. LTS-5x03A	LTD-5x21A/5x23A	LTD-5x27A/5x28A
1	Cathode E	Anode E	Seg. E (Digit 1)	Seg. Ml (Digit 1)
2	Cathode D	Anode D	Seg. D (Digit 1)	Seg. Pl (Digit 1)
3	Common Anode*1	Common Cathode*1	Seg. C (Digit 1)	Seg. C (Digit 1)
4	Cathode C	Anode C	D. P. (Digit 1)	D. P. (Digit 1)
5	Cathode D.P.	Anode D.P.	Seg. E (Digit 2)	Seg. E (Digit 2)
6	Cathode B	Anode B	Seg. D (Digit 2)	Seg. D (Digit 2)
7	Cathode A	Anode A	Seg. G (Digit 2)	Seg. G (Digit 2)
8	Common Anode*1	Common Cathode *1	Seg. C (Digit 2)	Seg. C (Digit 2)
9	Cathode F	Anode F	D. P. (Digit 2)	D. P. (Digit 2)
10	Cathode G	Anode G	Seg. B (Digit 2)	Seg. B (Digit 2)
11	—	—	Seg. A (Digit 2)	Seg. A (Digit 2)
12	—	—	Seg. F (Digit 2)	Seg. F (Digit 2)
13	—	—	Common (Digit 2)	Common (Digit 2)
14	—	—	Common (Digit 1)	Common (Digit 1)
15	—	—	Seg. B (Digit 1)	Seg. B (Digit 1)
16	—	—	Seg. A (Digit 1)	No Connection
17	—	—	Seg. G (Digit 1)	No Connection
18	—	—	Seg. F (Digit 1)	No Connection

Notes: Pin 3 & 8 are internally connected.

SEVEN-SEGMENT  
LED DISPLAYS

www.DataSheet4U.com

# INTERNAL CIRCUIT DIAGRAM

LTS-5x01A

www.DataSheet4U.com

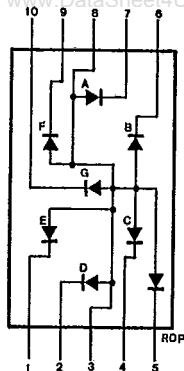

LTD-5x21A

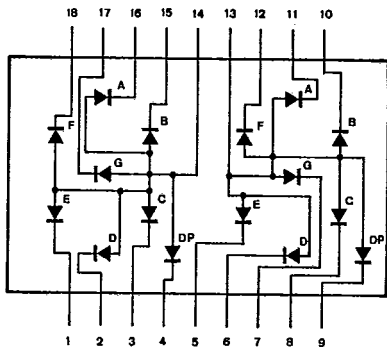

LTD-5x27A

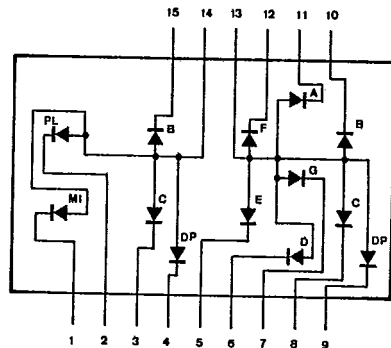

LTS-5x03A

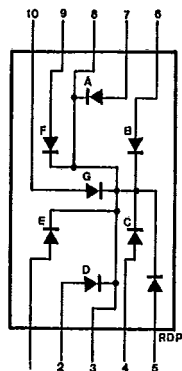

LTD-5x23A

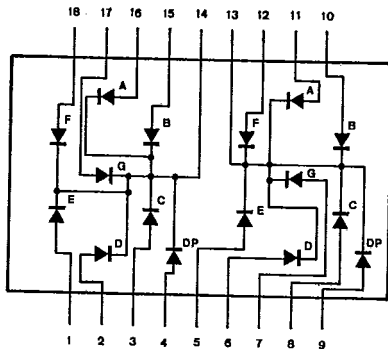

LTD-5x28A

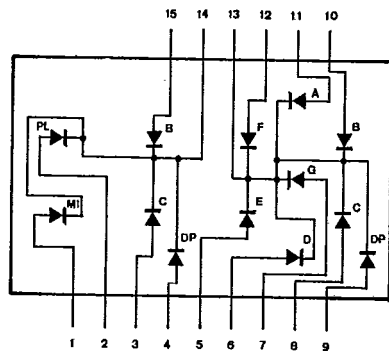

## ABSOLUTE MAXIMUM RATINGS AT $T_A = 25^\circ\text{C}$

PARAMETER	RED	BRIGHT RED	GREEN	YELLOW	ORANGE	UNIT
Power Dissipation Per Segment	55	40	75	60	75	mW
Peak Forward Current Per Segment (1/10 Duty Cycle, 0.1ms Pulse Width)	160	60	100	80	100	mA
Continuous Forward Current Per Segment	25	15	25	20	25	mA
Derating Linear From $25^\circ\text{C}$ Per Segment	0.3	0.18	0.3	0.24	0.3	mA/ $^\circ\text{C}$
Reverse Voltage Per Segment	5	5	5	5	5	V
Operating Temperature Range	- $25^\circ\text{C}$ to + $85^\circ\text{C}$					
Storage Temperature Range	- $25^\circ\text{C}$ to + $85^\circ\text{C}$					
Solder Temperature 1/16 inch Below Seating Plane for 3 Seconds at $260^\circ\text{C}$ .						www.DataSheet4U.com

**ELECTRICAL/OPTICAL CHARACTERISTICS AT  $T_A = 25^\circ\text{C}$**   
**LTD-5301AR/5303AR/LTD-5321AR/5323AR/5327AR/5328AR**

PARAMETER	SYMBOL	MIN.	TYP.	MAX.	UNIT	TEST CONDITION
Average Luminous Intensity	$I_v$	200	600		$\mu\text{cd}$	$I_F = 10\text{ mA}$
Peak Emission Wavelength	$\lambda_p$		655		nm	$I_F = 20\text{ mA}$
Spectral Line Half-Width	$\Delta\lambda$		24		nm	$I_F = 20\text{ mA}$
Forward Voltage, any Segment or D.P.	$V_F$		1.7	2.0	V	$I_F = 20\text{ mA}$
Reverse Current, any Segment or D.P.	$I_R$			100	$\mu\text{A}$	$V_R = 5\text{ V}$
Luminous Intensity Matching Ratio	$I_v\text{-m}$			2:1		$I_F = 20\text{ mA}$

Note: The BIN brightness classification see page 6-160, category B

**TYPICAL ELECTRICAL/OPTICAL CHARACTERISTIC CURVES**

( $25^\circ\text{C}$  Ambient Temperature Unless Otherwise Noted)

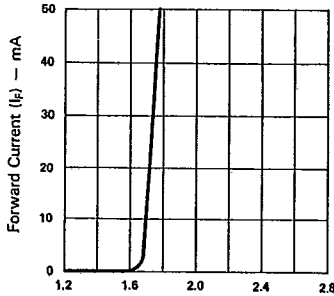

Fig. 1 FORWARD CURRENT Vs. FORWARD VOLTAGE.

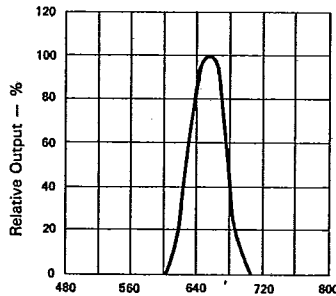

Fig. 2 SPECTRAL RESPONSE.

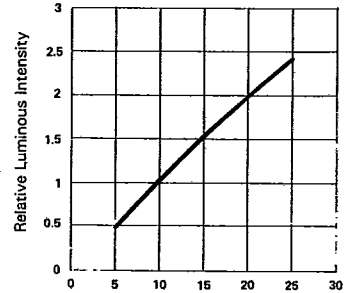

Fig. 3 RELATIVE LUMINOUS INTENSITY Vs. FORWARD CURRENT (PER SEGMENT).

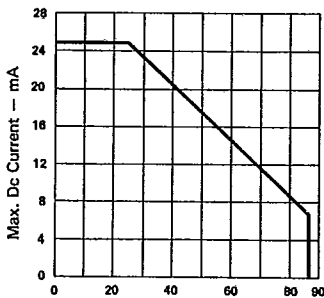

Fig. 4 MAX. ALLOWABLE DC CURRENT PER SEG. Vs AMBIENT TEMPERATURE.

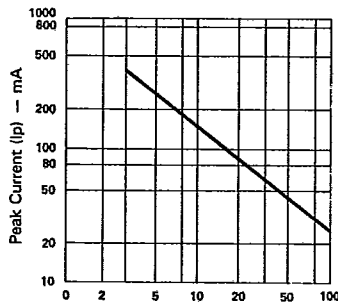

Fig. 5 MAX. PEAK CURRENT Vs. DUTY CYCLE.% (REFRESH RATE - F = 1 KHz)

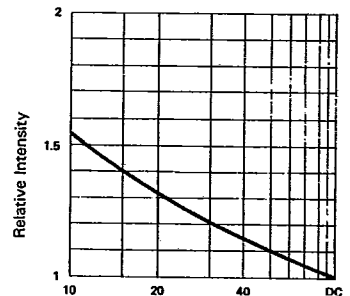

Fig. 6 LUMINOUS INTENSITY Vs. DUTY CYCLE.% (AVERAGE  $I_F = 10\text{mA}$  PER SEG.)

**ELECTRICAL/OPTICAL CHARACTERISTICS AT  $T_A = 25^\circ\text{C}$**   
**LTS-5301AP/5303AP/LTD-5321AP/5323AP/5327AP/5328AP**

PARAMETER	SYMBOL	MIN.	TYP.	MAX.	UNIT	TEST CONDITION
Average Luminous Intensity	$I_v$	350	950		$\mu\text{cd}$	$I_F = 10\text{ mA}$
Peak Emission Wavelength	$\lambda_p$		697		nm	$I_F = 20\text{ mA}$
Spectral Line Half-Width	$\Delta\lambda$		90		nm	$I_F = 20\text{ mA}$
Forward Voltage, any Segment or D.P.	$V_F$		2.1	2.8	V	$I_F = 20\text{ mA}$
Reverse Current, any Segment or D.P.	$I_R$			100	$\mu\text{A}$	$V_R = 5\text{ V}$
Luminous Intensity Matching Ratio	$I_v\text{-m}$			2:1		$I_F = 20\text{ mA}$

Note: The BIN brightness classification see page 6-160, category B

**TYPICAL ELECTRICAL/OPTICAL CHARACTERISTIC CURVES**

( $25^\circ\text{C}$  Ambient Temperature Unless Otherwise Noted)

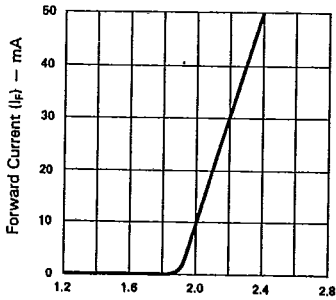

Fig. 1 FORWARD CURRENT Vs. FORWARD VOLTAGE.

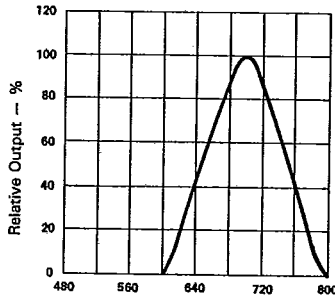

Fig. 2 SPECTRAL RESPONSE.

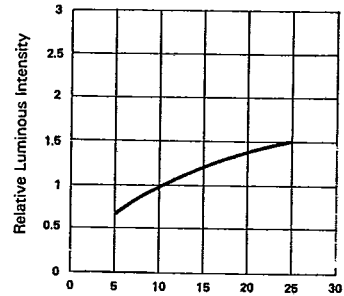

Fig. 3 RELATIVE LUMINOUS INTENSITY Vs. FORWARD CURRENT (PER SEGMENT).

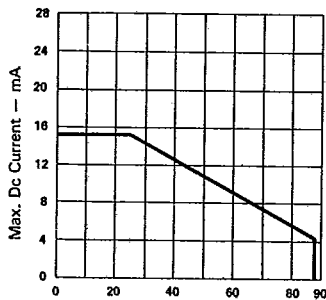

Fig. 4 MAX. ALLOWABLE DC CURRENT PER SEG. Vs AMBIENT TEMPERATURE.

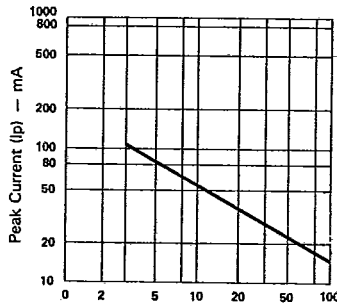

Fig. 5 MAX. PEAK CURRENT Vs. DUTY CYCLE.% (REFRESH RATE -  $F = 1\text{ KHz}$ )

# ELECTRICAL/OPTICAL CHARACTERISTICS AT $T_A = 25^\circ\text{C}$

## LTS-5601AG/5603AG/LTD-5621AG/5623AG/5627AG/5628AG

PARAMETER	SYMBOL	MIN.	TYP.	MAX.	UNIT	TEST CONDITION
Average Luminous Intensity	$I_v$	900	2400		$\mu\text{cd}$	$I_F = 10\text{ mA}$
Peak Emission Wavelength	$\lambda_p$		565		nm	$I_F = 20\text{ mA}$
Spectral Line Half-Width	$\Delta\lambda$		30		nm	$I_F = 20\text{ mA}$
Forward Voltage, any Segment or D.P.	$V_F$		2.1	2.8	V	$I_F = 20\text{ mA}$
Reverse Current, any Segment or D.P.	$I_R$			100	$\mu\text{A}$	$V_R = 5\text{ V}$
Luminous Intensity Matching Ratio	$I_v\text{-m}$			2:1		$I_F = 20\text{ mA}$

Note: The BIN brightness classification see page 6-160, category B

### TYPICAL ELECTRICAL/OPTICAL CHARACTERISTIC CURVES

( $25^\circ\text{C}$  Ambient Temperature Unless Otherwise Noted)

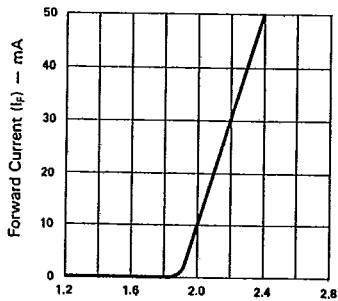

Fig. 1 FORWARD CURRENT Vs. FORWARD VOLTAGE.

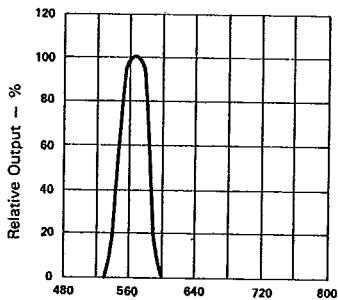

Fig. 2 SPECTRAL RESPONSE.

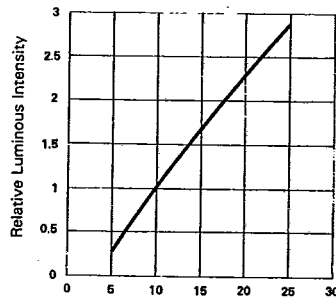

Fig. 3 RELATIVE LUMINOUS INTENSITY Vs. FORWARD CURRENT (PER SEGMENT).

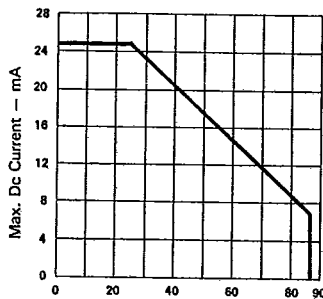

Fig. 4 MAX. ALLOWABLE DC CURRENT PER SEG. Vs AMBIENT TEMPERATURE.

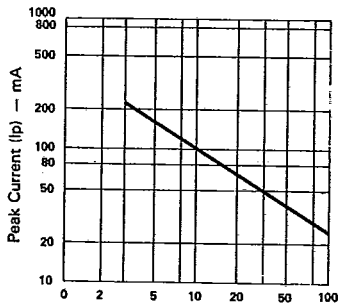

Fig. 5 MAX. PEAK CURRENT Vs. DUTY CYCLE % (REFRESH RATE - F = 1 KHz)

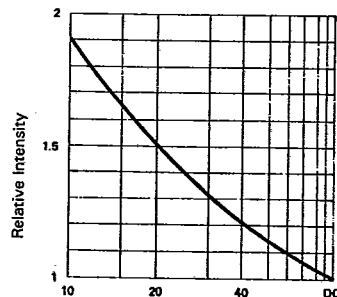

Fig. 6 LUMINOUS INTENSITY Vs. DUTY CYCLE % (AVERAGE  $I_F = 10\text{ mA}$  PER SEG.)

**ELECTRICAL/OPTICAL CHARACTERISTICS AT  $T_A = 25^\circ\text{C}$**   
**LTS-5701AY/5703AY/LTD-5721AY/5723AY/5727AY/5728AY**

PARAMETER	SYMBOL	MIN.	TYP.	MAX.	UNIT	TEST CONDITION
Average Luminous Intensity	$I_v$	750	2400		$\mu\text{cd}$	$I_F = 10 \text{ mA}$
Peak Emission Wavelength	$\lambda_p$		585		nm	$I_F = 20 \text{ mA}$
Spectral Line Half-Width	$\Delta\lambda$		35		nm	$I_F = 20 \text{ mA}$
Forward Voltage, any Segment or D.P.	$V_F$		2.1	2.8	V	$I_F = 20 \text{ mA}$
Reverse Current, any Segment or D.P.	$I_R$			100	$\mu\text{A}$	$V_R = 5 \text{ V}$
Luminous Intensity Matching Ratio	$I_v\text{-m}$			2:1		$I_F = 20 \text{ mA}$

Note: The BIN brightness classification see page 6-160, category B

**TYPICAL ELECTRICAL/OPTICAL CHARACTERISTIC CURVES**

( $25^\circ\text{C}$  Ambient Temperature Unless Otherwise Noted)

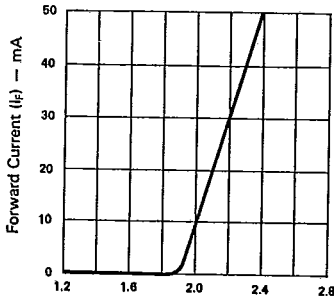

Fig. 1 FORWARD CURRENT Vs. FORWARD VOLTAGE.

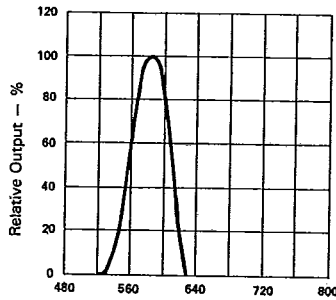

Fig. 2 SPECTRAL RESPONSE.

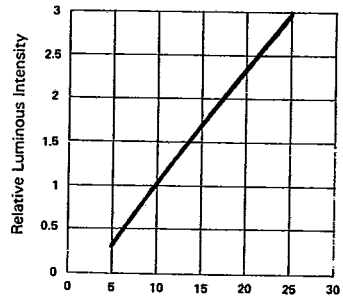

Fig. 3 RELATIVE LUMINOUS INTENSITY Vs. FORWARD CURRENT (PER SEGMENT).

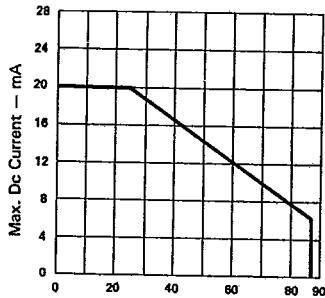

Fig. 4 MAX. ALLOWABLE DC CURRENT PER SEG. Vs AMBIENT TEMPERATURE.

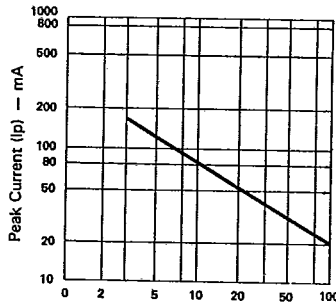

Fig. 5 MAX. PEAK CURRENT Vs. DUTY CYCLE.% (REFRESH RATE -  $F = 1 \text{ KHz}$ )

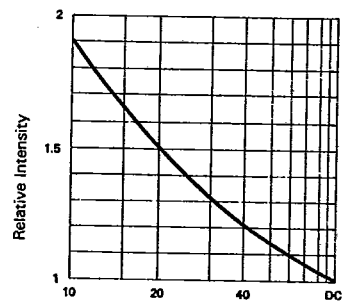

Fig. 6 LUMINOUS INTENSITY Vs. DUTY CYCLE.% (AVERAGE  $I_f = 10 \text{ mA}$  PER SEG.)

# ELECTRICAL/OPTICAL CHARACTERISTICS AT $T_A = 25^\circ\text{C}$

LTC5501AE/5503AE/LTD-5521AE/5523AE/5527AE/5528AE

PARAMETER	SYMBOL	MIN.	TYP.	MAX.	UNIT	TEST CONDITION
Average Luminous Intensity	$I_V$	900	2400		$\mu\text{cd}$	$I_F = 10\text{ mA}$
Peak Emission Wavelength	$\lambda_p$		630		nm	$I_F = 20\text{ mA}$
Spectral Line Half-Width	$\Delta\lambda$		40		nm	$I_F = 20\text{ mA}$
Forward Voltage, any Segment or D.P.	$V_F$		2.1	2.8	V	$I_F = 20\text{ mA}$
Reverse Current, any Segment or D.P.	$I_R$			100	$\mu\text{A}$	$V_R = 5\text{ V}$
Luminous Intensity Matching Ratio	$I_V\text{-m}$			2:1		$I_F = 20\text{ mA}$

Note: The BIN brightness classification see page 6-160, category B-1

## TYPICAL ELECTRICAL/OPTICAL CHARACTERISTIC CURVES

( $25^\circ\text{C}$  Ambient Temperature Unless Otherwise Noted)

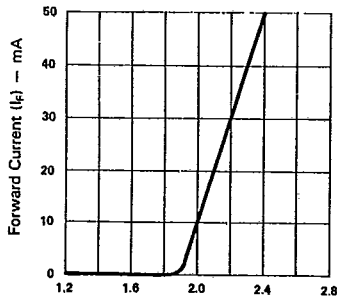

Forward Voltage ( $V_F$ ) — Volts  
Fig. 1 FORWARD CURRENT VS. FORWARD VOLTAGE.

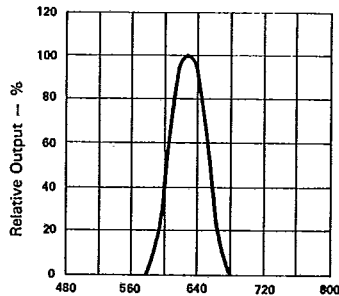

Wavelength ( $\lambda$ ) — nm.  
Fig. 2 SPECTRAL RESPONSE.

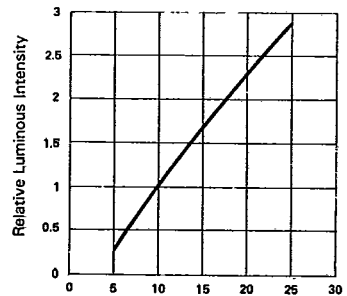

Forward Current ( $I_F$ ) — mA  
Fig. 3 RELATIVE, LUMINOUS INTENSITY VS. FORWARD CURRENT (PER SEGMENT).

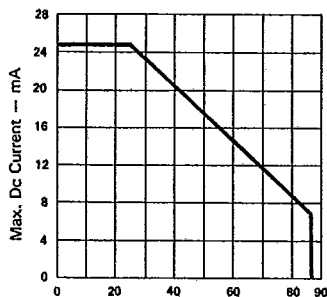

Ambient Temperature ( $T_A$ ) —  $^\circ\text{C}$   
Fig. 4 MAX. ALLOWABLE DC CURRENT PER SEG. VS AMBIENT TEMPERATURE.

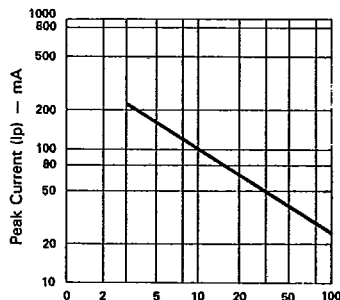

Duty Cycle %  
Fig. 5 MAX. PEAK CURRENT VS. DUTY CYCLE.% (REFRESH RATE —  $F = 1\text{ KHz}$ )

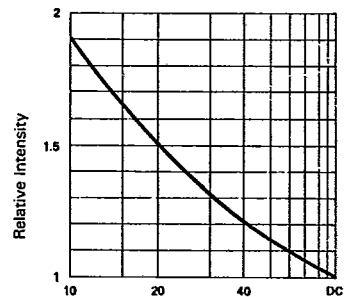

Fig. 6 LUMINOUS INTENSITY VS. DUTY CYCLE.% (AVERAGE  $I_F = 10\text{ mA}$  PER SEG.)