



# UNISONIC TECHNOLOGIES CO., LTD

## 2SC2235

## NPN SILICON TRANSISTOR

AUDIO POWER AMPLIFIER  
APPLICATIONS DRIVER STAGE  
AMPLIFIER APPLICATIONS

### FEATURES

\* Complimentary to UTC 2SA965

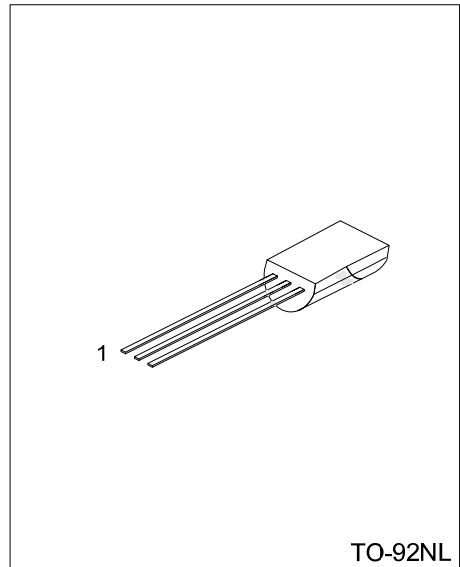

Lead-free: 2SC2235L  
Halogen-free: 2SC2235G

### ORDERING INFORMATION

Ordering Number			Package	Pin Assignment			Packing
Normal	Lead Free	Halogen Free		1	2	3	
2SC2235-x-T9N-B	2SC2235L-x-T9N-B	2SC2235G-x-T9N-B	TO-92NL	E	C	B	Tape Box
2SC2235-x-T9N-K	2SC2235L-x-T9N-K	2SC2235G-x-T9N-K	TO-92NL	E	C	B	Bulk

<p>2SC2235L-x-T9N-B</p> <p>(1) Packing Type (2) Package Type (3) Rank (4) Lead Plating</p>	<p>(1) B: Tape Box, K: Bulk (2) T9N: TO-92NL (3) x: refer to Classification of <math>h_{FE}</math> (4) G: Halogen Free, L: Lead Free, Blank: Pb/Sn</p>
--	--

■ ABSOLUTE MAXIMUM RATING ( Ta=25°C ,unless otherwise specified )

PARAMETER	SYMBOL	RATINGS	UNIT
Collector-Base Voltage	$V_{CBO}$	120	V
Collector-Emitter Voltage	$V_{CEO}$	120	V
Emitter-Base Voltage	$V_{EBO}$	5	V
Collector Current	$I_C$	800	mA
Emitter Current	$I_E$	-800	mA
Collector Power Dissipation	$P_C$	900	mW
Junction Temperature	$T_J$	150	°C
Storage Temperature	$T_{STG}$	-55 ~ +150	°C

Note: Absolute maximum ratings are those values beyond which the device could be permanently damaged.

Absolute maximum ratings are stress ratings only and functional device operation is not implied.

■ ELECTRICAL CHARACTERISTICS (Ta=25°C,unless otherwise specified)

PARAMETER	SYMBOL	TEST CONDITIONS	MIN	TYP	MAX	UNIT
Collector-Emitter Breakdown Voltage	$V_{B_{CEO}}$	$I_C = 10\text{mA}, I_B = 0$	120			V
Emitter-Base Breakdown Voltage	$V_{B_{EBO}}$	$I_E = 1\text{mA}, I_C = 0$	5			V
Collector Cut-off Current	$I_{CBO}$	$V_{CB} = 120\text{V}, I_E = 0$			100	nA
Emitter Cut-off Current	$I_{EBO}$	$V_{EB} = 5\text{V}, I_C = 0$			100	nA
DC Current Gain	$h_{FE}$	$V_{CE} = 5\text{V}, I_C = 100\text{mA}$	80		240	
Collector-Emitter Saturation Voltage	$V_{CE(SAT)}$	$I_C = 500\text{mA}, I_B = 50\text{mA}$			1.0	V
Base-Emitter Voltage	$V_{BE}$	$V_{CE} = 5\text{V}, I_C = 500\text{mA}$			1.0	V
Transition Frequency	$f_T$	$V_{CE} = 5\text{V}, I_C = 100\text{mA}$		120		MHz
Collector Output Capacitance	$C_{ob}$	$V_{CB} = 10\text{V}, I_E = 0, f = 1\text{MHz}$			30	pF

■ CLASSIFICATION OF  $h_{FE}$

RANK	Y	O
RANGE	120-240	80-160

■ TYPICAL CHARACTERISTICS

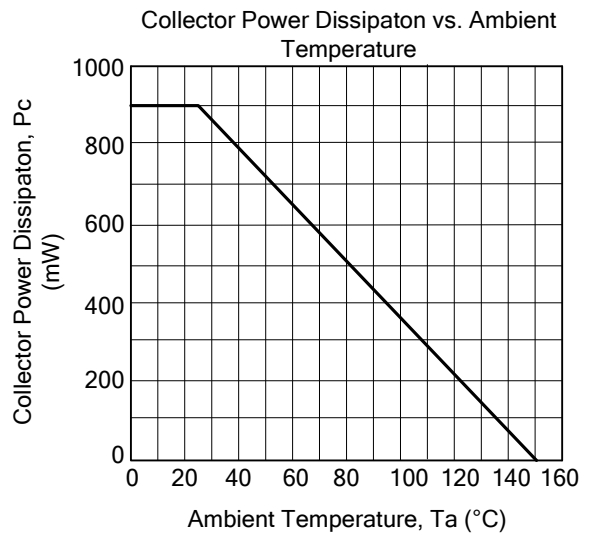
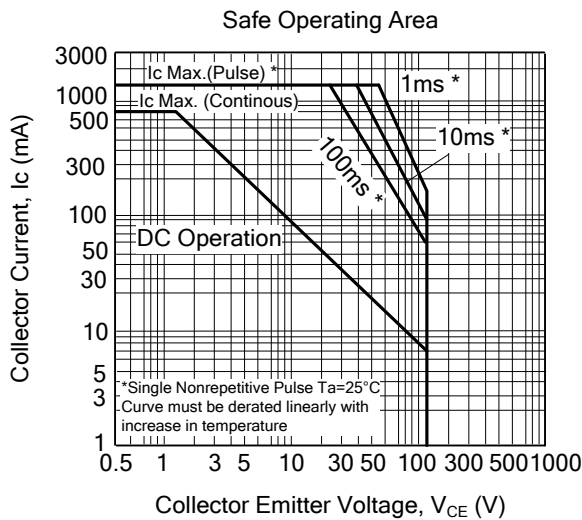
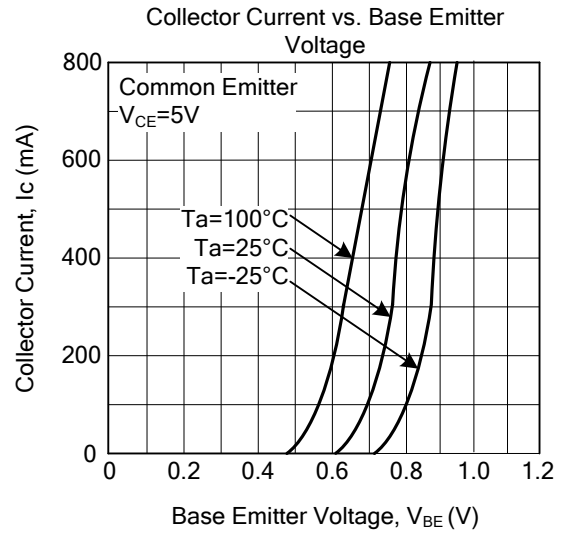
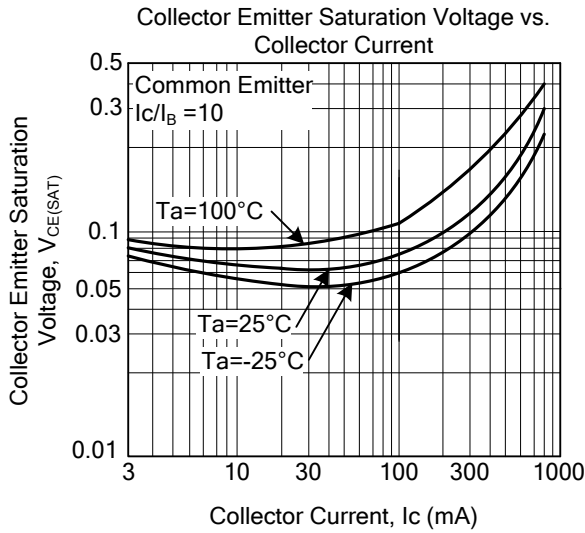
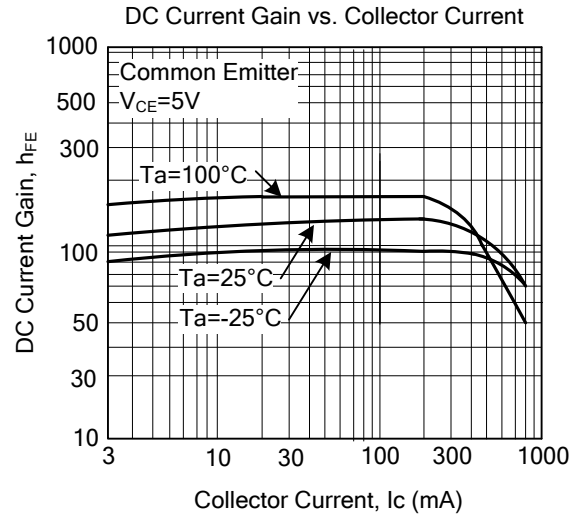
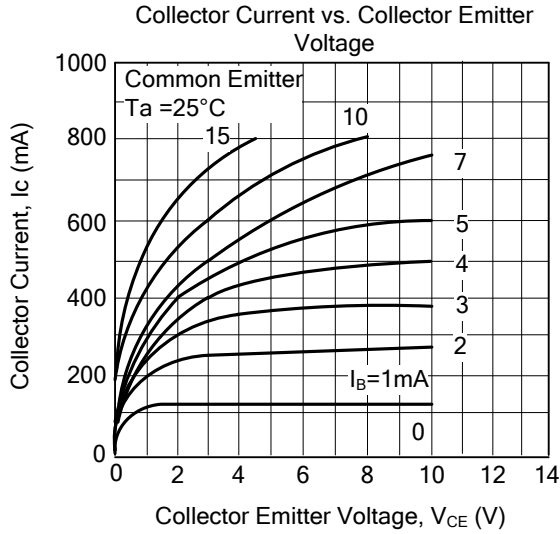

UTC assumes no responsibility for equipment failures that result from using products at values that exceed, even momentarily, rated values (such as maximum ratings, operating condition ranges, or other parameters) listed in products specifications of any and all UTC products described or contained herein. UTC products are not designed for use in life support appliances, devices or systems where malfunction of these products can be reasonably expected to result in personal injury. Reproduction in whole or in part is prohibited without the prior written consent of the copyright owner. The information presented in this document does not form part of any quotation or contract, is believed to be accurate and reliable and may be changed without notice.