



A28F200BX-T/B 2-MBIT (128K x 16, 256K x 8) BOOT BLOCK FLASH MEMORY FAMILY

Automotive

- **x8/x16 Input/Output Architecture**
 - A28F200BX-T, A28F200BX-B
 - For High Performance and High Integration 16-bit and 32-bit CPUs
 - **Optimized High Density Blocked Architecture**
 - One 16 KB Protected Boot Block
 - Two 8 KB Parameter Blocks
 - One 96 KB Main Block
 - One 128 KB Main Block
 - Top or Bottom Boot Locations
 - **Extended Cycling Capability**
 - 1,000 Block Erase Cycles
 - **Automated Word/Byte Write and Block Erase**
 - Command User Interface
 - Status Register
 - Erase Suspend Capability
 - **SRAM-Compatible Write Interface**
 - **Automatic Power Savings Feature**
 - 1 mA Typical I_{CC} Active Current in Static Operation
 - **Hardware Data Protection Feature**
 - Erase/Write Lockout during Power Transitions
 - **Very High-Performance Read**
 - 90 ns Maximum Access Time
 - 45 ns Maximum Output Enable Time
 - **Low Power Consumption**
 - 25 mA Typical Active Read Current
 - **Deep Power-Down/Reset Input**
 - Acts as Reset for Boot Operations
 - **Automotive Temperature Operation**
 - -40°C to $+125^{\circ}\text{C}$
 - **Write Protection for Boot Block**
 - **Industry Standard Surface Mount Packaging**
 - JEDEC ROM Compatible
 - 44-Lead PSOP
 - **12V Word/Byte Write and Block Erase**
 - $V_{PP} = 12\text{V} \pm 5\%$ Standard
 - **ETOX™ III Flash Technology**
 - 5V Read
 - **Independent Software Vendor Support**
-

*Other brands and names are the property of their respective owners.
Information in this document is provided in connection with Intel products. Intel assumes no liability whatsoever, including infringement of any patent or copyright, for sale and use of Intel products except as provided in Intel's Terms and Conditions of Sale for such products. Intel retains the right to make changes to these specifications at any time, without notice. Microcomputer Products may have minor variations to this specification known as errata.
COPYRIGHT © INTEL CORPORATION, 1995

November 1995

Order Number: 290500-003

A28F200BX-T/B



Intel's 2-Mbit Flash Memory Family is an extension of the Boot Block Architecture which includes block-selective erasure, automated write and erase operations and standard microprocessor interface. The 2 Mbit Flash Memory Family enhances the Boot Block Architecture by adding more density and blocks, x8/x16 input/output control, very high speed, low power, an industry standard ROM compatible pinout. The 2-Mbit flash family allows for an easy upgrade to Intel's 4-Mbit Boot Block Flash Memory Family.

The Intel A28F200BX-T/B are 16-bit wide flash memory offerings optimized to meet the rigorous environmental requirements of Automotive Applications. These high density flash memories provide user selectable bus operation for either 8-bit or 16-bit applications. The A28F200BX-T and A28F200BX-B are 2,097,152-bit non-volatile memories organized as either 262,144 bytes or 131,072 words of information. They are offered in 44-Lead plastic SOP packages. The x8/x16 pinout conforms to the industry standard ROM/EPROM pinout. Read and Write Characteristics are guaranteed over the ambient temperature range of -40°C to $+125^{\circ}\text{C}$.

These devices use an integrated Command User Interface (CUI) and Write State Machine (WSM) for simplified word/byte write and block erasure. The A28F200BX-T provides block locations compatible with Intel's MCS-186 family, 80286, i386™, i486™, i860™ and 80960CA microprocessors. The A28F200BX-B provides compatibility with Intel's 80960KX and 80960SX families as well as other embedded microprocessors.

The boot block includes a data protection feature to protect the boot code in critical applications. With a maximum access time of 90 ns, these 2 Mbit flash devices are very high performance memories which interface at zero-wait-state to a wide range of microprocessors and microcontrollers.

Manufactured on Intel's 0.8 micron ETOX™ III process, the 2-Mbit flash memory family provides world class quality, reliability and cost-effectiveness at the 2-Mbit density level.

1.0 PRODUCT FAMILY OVERVIEW

Throughout this datasheet the A28F200BX refers to both the A28F200BX-T and A28F200BX-B devices. Section 1 provides an overview of the 2-Mbit flash memory family including applications, pinouts and pin descriptions. Section 2 describes in detail the specific memory organization. Section 3 provides a description of the family's principles of operation. Finally, the family's operating specifications are described.

1.1 Main Features

The A28F200BX boot block flash memory family is a very high performance 2-Mbit (2,097,152 bit) memory family organized as either 128-KWords (131,072 words) of 16 bits each or 256-Kbytes (262,144 bytes) of 8 bits each.

Five Separately Erasable Blocks including a **hardware-lockable boot block** (16,384 Bytes), **two parameter blocks** (8,192 Bytes each) and **two main blocks** (1 block of 98,304 Bytes and 1 block of 131,072 Bytes) are included on the 2-Mbit family. An erase operation erases one of the main blocks in typically 3 seconds, and the boot or parameter blocks in typically 1.5 seconds. Each block can be independently erased and programmed 1,000 times.

The Boot Block is located at either the top (A28F200BX-T) or the bottom (A28F200BX-B) of the address map in order to accommodate different microprocessor protocols for boot code location. The **hardware lockable boot block** provides the most secure code storage. The boot block is intended to store the kernel code required for booting-up a system. When the **RP#** pin is between 11.4V and 12.6V the boot block is unlocked and program and erase operations can be performed. When the **RP#** pin is at or below 6.5V the boot block is locked and program and erase operations to the boot block are ignored.

The A28F200BX products are available in the ROM/EPROM compatible pinout and housed in the 44-Lead PSOP (Plastic Small Outline) package as shown in Figure 3.

The **Command User Interface (CUI)** serves as the interface between the microprocessor or microcontroller and the internal operation of the A28F200BX flash memory.

Program and Erase Automation allows program and erase operations to be executed using a two-write command sequence to the CUI. The internal Write State Machine (WSM) automatically executes the algorithms and timings necessary for program and erase operations, including verifications, thereby unburdening the microprocessor or microcontroller. Writing of memory data is performed in word or byte increments for the A28F200BX family typically within 9 μ s which is a 100% improvement over previous flash memory products.

The **Status Register (SR)** indicates the status of the WSM and whether the WSM successfully completed the desired program or erase operation.

Maximum Access Time of **90 ns (TACC)** is achieved over the automotive temperature range (-40°C to 125°C), 10% V_{CC} supply voltage range and 100 pF output load.

Ipp maximum Program current is 40 mA for x16 operation and 30 mA for x8 operation. Ipp Erase current is 30 mA maximum. Vpp erase and programming voltage is 11.4V to 12.6V ($V_{PP} = 12V \pm 5\%$) under all operating conditions. Typical Icc Active Current of 25 mA is achieved.

The 2-Mbit boot block flash family is also designed with an Automatic Power Savings (APS) feature to minimize system battery current drain and allow for very low power designs. Once the device is accessed to read array data, APS mode will immediately put the memory in static mode of operation where I_{CC} active current is typically 1 mA until the next read is initiated.

When the **CE#** and **RP#** pins are at V_{CC} and the **BYTE#** pin is at either V_{CC} or **GND** the **CMOS Standby** mode is enabled where I_{CC} is typically 80 μ A.

A **Deep Power-Down Mode** is enabled when the **RP#** pin is at ground minimizing power consumption and providing write protection during power-up conditions. **Icc current** during deep power-down mode is **50 μ A typical**. An initial maximum access time or Reset Time of 300 ns is required from **RP#** switching until outputs are valid. Equivalently, the device has a maximum wake-up time of 210 ns until writes to the Command User Interface are recognized.

When RP# is at ground the WSM is reset, the Status Register is cleared and the entire device is protected from being written to. This feature prevents data corruption and protects the code stored in the device during system reset. The system Reset pin can be tied to RP# to reset the memory to normal read mode upon activation of the Reset pin. With on-chip program/erase automation in the 2 Mbit family and the RP# functionality for data protection, when the CPU is reset and even if a program or erase command is issued, the device will not recognize any operation until RP# returns to its normal state.

For the A28F200BX, Byte-wide or Word-wide Input/Output Control is possible by controlling the BYTE# pin. When the BYTE# pin is at a logic low the device is in the byte-wide mode (x8) and data is read and written through DQ[0:7]. During the byte-wide mode, DQ[8:14] are tri-stated and DQ15/A-1 becomes the lowest order address pin. When the BYTE# pin is at a logic high the device is in the word-wide mode (x16) and data is read and written through DQ[0:15].

1.2 Applications

The 2-Mbit boot block flash family combines high density, high performance, cost-effective flash memories with blocking and hardware protection capabilities. Its flexibility and versatility will reduce costs throughout the product life cycle. Flash memory is ideal for Just-In-Time production flow, reducing system inventory and costs, and eliminating component handling during the production phase. During the product life cycle, when code updates or feature enhancements become necessary, flash memory will reduce the update costs by allowing either a user-performed code change via floppy disk or a remote code change via a serial link. The 2-Mbit boot block flash family provides full function, blocked flash memories suitable for a wide range of automotive applications.

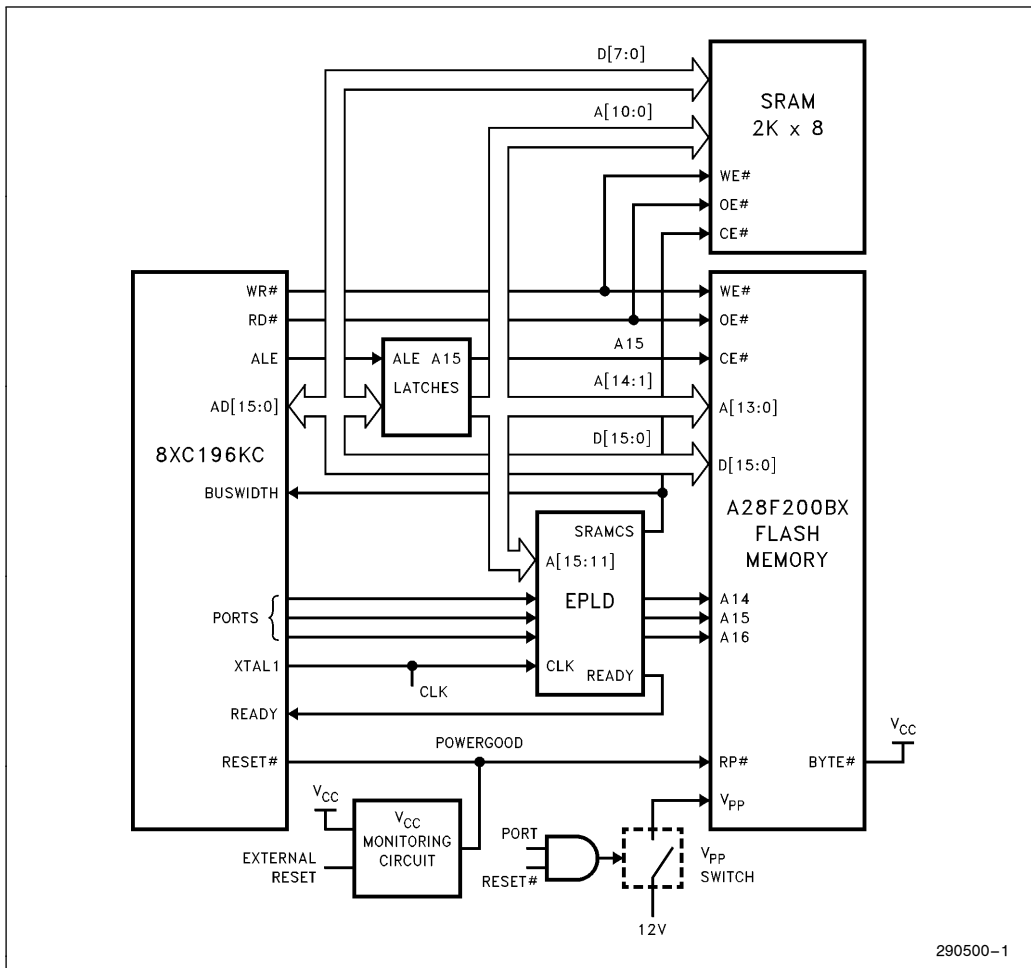

Figure 1. A28F200BX Interface to 8XC196KC

290500-1

1.3 Pinouts

The A28F200BX 44-Lead PSOP pinout follows the industry standard ROM/EPROM pinout as shown in Figure 2 with an upgrade to the 28F400BC (4-Mbit flash family).

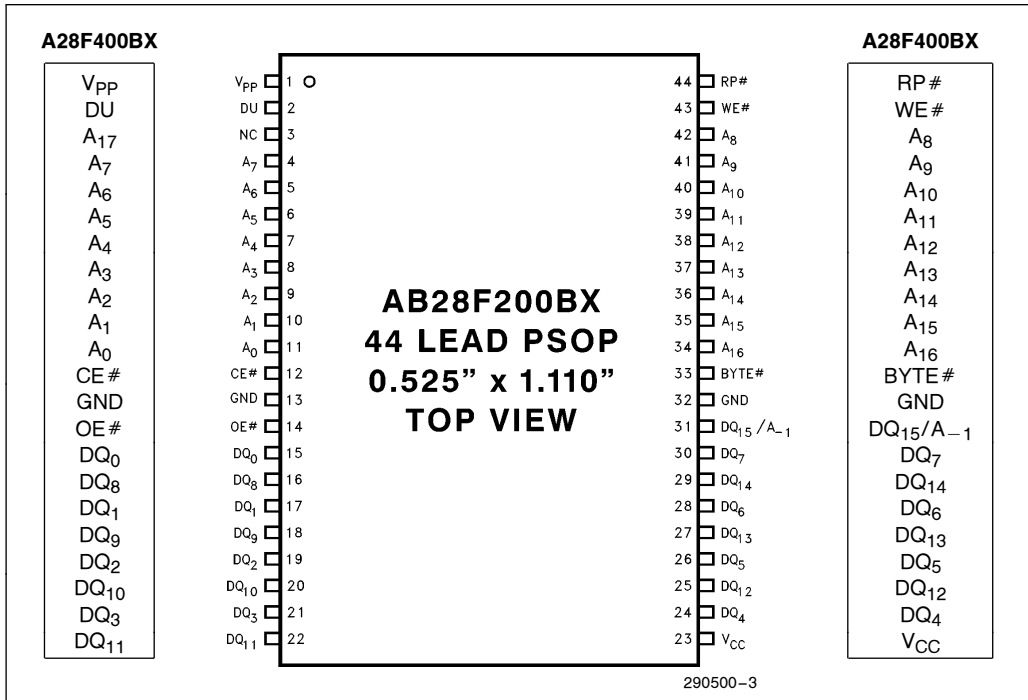

Figure 2. PSOP Lead Configuration

1.4 Pin Descriptions for the x8/x16 A28F200BX

Symbol	Type	Name and Function
A ₀ –A ₁₆	I	ADDRESS INPUTS for memory addresses. Addresses are internally latched during a write cycle.
A ₉	I	ADDRESS INPUT: When A ₉ is at 12V the signature mode is accessed. During this mode A ₀ decodes between the manufacturer and device ID's. When BYTE # is at a logic low only the lower byte of the signatures are read. DQ ₁₅ /A _{–1} is a don't care in the signature mode when BYTE # is low.
DQ ₀ –DQ ₇	I/O	DATA INPUTS/OUTPUTS: Inputs array data on the second CE # and WE # cycle during a program command. Inputs commands to the Command User Interface when CE # and WE # are active. Data is internally latched during the write and program cycles. Outputs array, intelligent identifier and Status Register data. The data pins float to tri-state when the chip is deselected or the outputs are disabled.
DQ ₈ –DQ ₁₅	I/O	DATA INPUTS/OUTPUTS: Inputs array data on the second CE # and WE # cycle during a program command. Data is internally latched during the write and program cycles. Outputs array data. The data pins float to tri-state when the chip is deselected or the outputs are disabled as in the byte-wide mode (BYTE # = "0"). In the byte-wide mode DQ ₁₅ /A _{–1} becomes the lowest order address for data output on DQ ₀ –DQ ₇ .
CE #	I	CHIP ENABLE: Activates the device's control logic, input buffers, decoders and sense amplifiers. CE # is active low; CE # high deselected the memory device and reduces power consumption to standby levels. If CE # and RP # are high, but not at a CMOS high level, the standby current will increase due to current flow through the CE # and RP # input stages.
RP #	I	RESET/POWER-DOWN: Provides three-state control. Puts the device in deep power-down mode. Locks the boot block from program/erase. When RP # is at logic high level and equals 6.5V maximum the boot block is locked and cannot be programmed or erased. When RP # = 11.4V minimum the boot block is unlocked and can be programmed or erased. When RP # is at a logic low level the boot block is locked, the deep power-down mode is enabled and the WSM is reset preventing any blocks from being programmed or erased, therefore providing data protection during power transitions. When RP # transitions from logic low to logic high the flash memory enters the read array mode.
OE #	I	OUTPUT ENABLE: Gates the device's outputs through the data buffers during a read cycle. OE # is active low.
WE #	I	WRITE ENABLE: Controls writes to the Command Register and array blocks. WE # is active low. Addresses and data are latched on the rising edge of the WE # pulse.
BYTE #	I	BYTE # ENABLE: Controls whether the device operates in the byte-wide mode (x8) or the word-wide mode (x16). BYTE # pin must be controlled at CMOS levels to meet 130 μA CMOS current in the standby mode. BYTE # = "0" enables the byte-wide mode, where data is read and programmed on DQ ₀ –DQ ₇ and DQ ₁₅ /A _{–1} becomes the lowest order address that decodes between the upper and lower byte. DQ ₈ –DQ ₁₄ are tri-stated during the byte-wide mode. BYTE # = "1" enables the word-wide mode where data is read and programmed on DQ ₀ –DQ ₁₅ .
V _{PP}		PROGRAM/ERASE POWER SUPPLY: For erasing memory array blocks or programming data in each block. Note: V _{PP} < V _{PPMAX} memory contents cannot be altered.
V _{CC}		DEVICE POWER SUPPLY (5V ± 10%)
GND		GROUND: For all internal circuitry.
NC		NO CONNECT: Pin may be driven or left floating.
DU		DON'T USE PIN: Pin should not be connected to anything.

2.0 A28F200BX WORD/BYTE-WIDE PRODUCTS DESCRIPTION

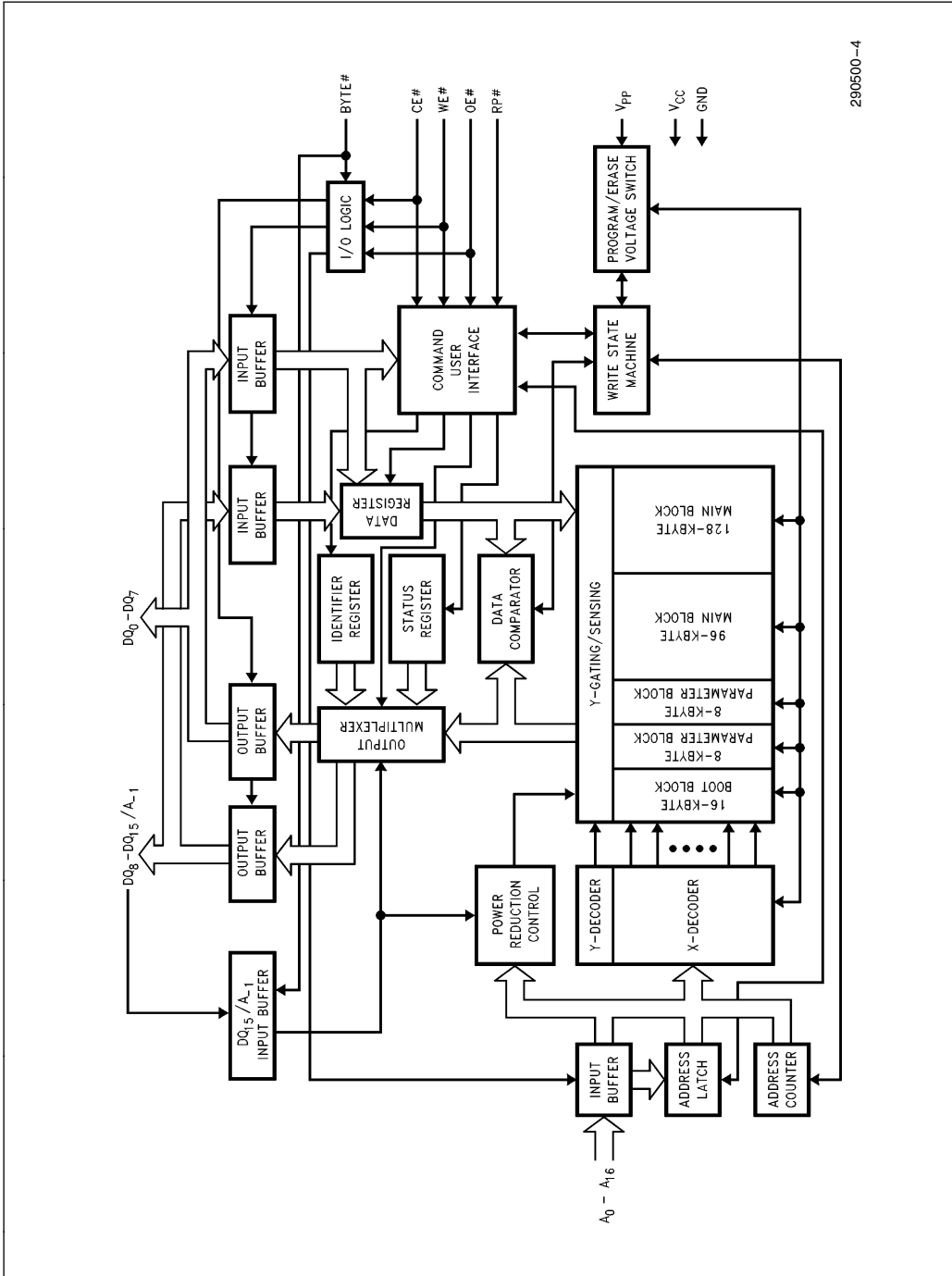

Figure 3. A28F200BX Word/Byte-Wide Block Diagram

2.1 A28F200BX Memory Organization

2.1.1 BLOCKING

The A28F200BX uses a blocked array architecture to provide independent erasure of memory blocks. A block is erased independently of other blocks in the array when an address is given within the block address range and the Erase Setup and Erase Confirm commands are written to the CUI. The A28F200BX is a random read/write memory, only erasure is performed by block.

2.1.1.1 Boot Block Operation and Data Protection

The 16-Kbyte boot block provides a lock feature for secure code storage. The intent of the boot block is to provide a secure storage area for the kernel code that is required to boot a system in the event of power failure or other disruption during code update. This lock feature ensures absolute data integrity by preventing the boot block from being written or erased when RP# is not at 12V. The boot block can be erased and written when RP# is held at 12V for the duration of the erase or program operation. This allows customers to change the boot code when necessary while providing security when needed. See the Block Memory Map section for address locations of the boot block for the A28F200BX-T and A28F200BX-B.

2.1.1.2 Parameter Block Operation

The A28F200BX has 2 parameter blocks (8-Kbytes each). The parameter blocks are intended to provide storage for frequently updated system parameters and configuration or diagnostic information. The parameter blocks can also be used to store additional boot or main code. The parameter blocks however, do not have the hardware write protection feature that the boot block has. The parameter blocks provide for more efficient memory utilization when dealing with parameter changes versus regularly blocked devices. See the Block Memory Map section for address locations of the parameter blocks for the A28F200BX-T and A28F200BX-B.

2.1.1.3 Main Block Operation

Two main blocks of memory exist on the A28F200BX (1 x 128-Kbyte block and 1 x 96-Kbyte block). See the following section on Block Memory Map for the address location of these blocks for the A28F200BX-T

and A28F200BX-B products.

2.1.2 BLOCK MEMORY MAP

Two versions of the A28F200BX product exist to support two different memory maps of the array blocks in order to accommodate different microprocessor protocols for boot code location. The A28F200BX-T memory map is inverted from the A28F200BX-B memory map.

2.1.2.1 A28F200BX-B Memory Map

The A28F200BX-B device has the 16-Kbyte boot block located from 00000H to 01FFFFH to accommodate those microprocessors that boot from the bottom of the address map at 00000H. In the A28F200BX-B the first 8-Kbyte parameter block resides in memory space from 02000H to 02FFFFH. The second 8-Kbyte parameter block resides in memory space from 03000H to 03FFFFH. The 96-Kbyte main block resides in memory space from 04000H to 0FFFFH. The 128-Kbyte main block resides in memory space from 10000H to 1FFFFH (word locations). See Figure 4.

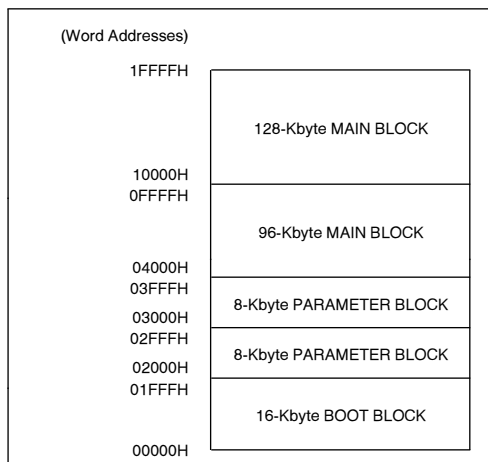

Figure 4. A28F200BX-B Memory Map

2.1.2.2 A28F200BX-T Memory Map

The A28F200BX-T device has the 16-Kbyte boot block located from 1E000H to 1FFFFH to accommodate those microprocessors that boot from the top of the address map. In the A28F200BX-T the first 8 Kbyte parameter block resides in memory space from 1D000H to 1DFFFFH. The second 8-Kbyte parameter block resides in memory space from 1C000H to 1CFFFFH. The 96-Kbyte main block resides in memory space from 10000H to 1BFFFFH. The 128-Kbyte main block resides in memory space from 00000H to 0FFFFH as shown in Figure 5.

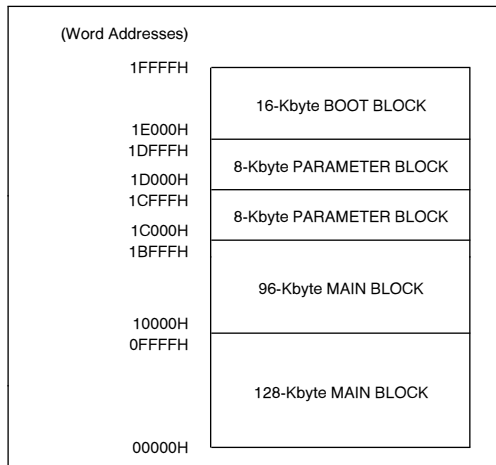

Figure 5. A28F200BX-T Memory Map

3.0 PRODUCT FAMILY PRINCIPLES OF OPERATION

Flash memory augments EPROM functionality with in-circuit electrical write and erase. The 2-Mbit flash family utilizes a Command User Interface (CUI) and internally generated and timed algorithms to simplify write and erase operations.

The CUI allows for 100% TTL-level control inputs, fixed power supplies during erasure and programming, and maximum EPROM compatibility.

In the absence of high voltage on the V_{PP} pin, the 2-Mbit boot block flash family will only successfully execute the following commands: Read Array, Read Status Register, Clear Status Register and Intelligent Identifier mode. The device provides standard EPROM read, standby and output disable operations. Manufacturer Identification and Device Identification data can be accessed through the CUI or through the standard EPROM A9 high voltage access (V_{ID}) for PROM programming equipment.

The same EPROM read, standby and output disable functions are available when high voltage is applied to the V_{PP} pin. In addition, high voltage on V_{PP} allows write and erase of the device. All functions associated with altering memory contents: write and erase, Intelligent Identifier read and Read Status are accessed via the CUI.

The purpose of the Write State Machine (WSM) is to completely automate the write and erasure of the device. The WSM will begin operation upon receipt of a signal from the CUI and will report status back through a Status Register. The CUI will handle the WE# interface to the data and address latches, as well as system software requests for status while the WSM is in operation.

3.1 Bus Operations

Flash memory reads, erases and writes in-system via the local CPU. All bus cycles to or from the flash memory conform to standard microprocessor bus cycles.

Table 1. Bus Operations for WORD-WIDE Mode (BYTE# = V_{IH})

Mode	Notes	RP#	CE#	OE#	WE#	A ₉	A ₀	V _{PP}	DQ ₀₋₁₅
Read	1, 2, 3	V _{IH}	V _{IL}	V _{IL}	V _{IH}	X	X	X	D _{OUT}
Output Disable		V _{IH}	V _{IL}	V _{IH}	V _{IH}	X	X	X	High Z
Standby		V _{IH}	V _{IH}	X	X	X	X	X	High Z
Deep Power-Down	9	V _{IL}	X	X	X	X	X	X	High Z
Intelligent Identifier (Mfr)	4	V _{IH}	V _{IL}	V _{IL}	V _{IH}	V _{ID}	V _{IL}	X	0089H
Intelligent Identifier (Device)	4, 5	V _{IH}	V _{IL}	V _{IL}	V _{IH}	V _{ID}	V _{IH}	X	2274H 2275H
Write	6, 7, 8	V _{IH}	V _{IL}	V _{IH}	V _{IL}	X	X	X	D _{IN}

Table 2. Bus Operations for BYTE-WIDE Mode (BYTE# = V_{IL})

Mode	Notes	RP#	CE#	OE#	WE#	A ₉	A ₀	A ₋₁	V _{PP}	DQ ₀₋₇	DQ ₈₋₁₄
Read	1, 2, 3	V _{IH}	V _{IL}	V _{IL}	V _{IH}	X	X	X	X	D _{OUT}	High Z
Output Disable		V _{IH}	V _{IL}	V _{IH}	V _{IH}	X	X	X	X	High Z	High Z
Standby		V _{IH}	V _{IH}	X	X	X	X	X	X	High Z	High Z
Deep Power-Down	9	V _{IL}	X	X	X	X	X	X	X	High Z	High Z
Intelligent Identifier (Mfr)	4	V _{IH}	V _{IL}	V _{IL}	V _{IH}	V _{ID}	V _{IL}	X	X	89H	High Z
Intelligent Identifier (Device)	4, 5	V _{IH}	V _{IL}	V _{IL}	V _{IH}	V _{ID}	V _{IH}	X	X	74H 75H	High Z
Write	6, 7, 8	V _{IH}	V _{IL}	V _{IH}	V _{IL}	X	X	X	X	D _{IN}	High Z

NOTES:

1. Refer to DC Characteristics.
2. X can be V_{IL} or V_{IH} for control pins and addresses, V_{PP}L or V_{PP}H for V_{PP}.
3. See DC characteristics for V_{PP}L, V_{PP}H, V_{HH}, V_{ID} voltages.
4. Manufacturer and Device codes may also be accessed via a CUI write sequence. A₁-A₁₇ = X.
5. Device ID = 2274H for A28F200BX-T and 2275H for A28F200BX-B.
6. Refer to Table 3 for valid D_{IN} during a write operation.
7. Command writes for Block Erase or Word/Byte Write are only executed when V_{PP} = V_{PP}H.
8. To write or erase the boot block, hold RP# at V_{HH}.
9. RP# must be at GND ±0.2V to meet the 80 μA maximum deep power-down current.

3.2 Read Operations

The 2-Mbit boot block flash family has three user read modes; Array, Intelligent Identifier, and Status Register. Status Register read mode will be discussed in detail in the “Write Operations” section.

During power-up conditions (V_{CC} supply ramping), it takes a maximum of 300 ns from when V_{CC} is at 4.5V minimum to valid data on the outputs.

3.2.1 READ ARRAY

If the memory is not in the Read Array mode, it is necessary to write the appropriate read mode command to the CUI. The 2-Mbit boot block flash family has three control functions, all of which must be logically active, to obtain data at the outputs. Chip-Enable CE# is the device selection control. Reset/Power-Down RP# is the device power control. Output-Enable OE# is the DATA INPUT/OUTPUT (DQ[0:15] or DQ[0:7]) direction control and when active is used to drive data from the selected memory on to the I/O bus.

3.2.1.1 Output Control

With OE# at logic-high level (V_{IH}), the output from the device is disabled and data input/output pins (DQ[0:15] or DQ[0:7]) are tri-stated. Data input is then controlled by WE#.

3.2.1.2 Input Control

With WE# at logic-high level (V_{IH}), input to the device is disabled. Data Input/Output pins (DQ-[0:15] or DQ[0:7]) are controlled by OE#.

3.2.2 INTELLIGENT IDENTIFIERS

The manufacturer and device codes are read via the CUI or by taking the A₉ pin to 12V. Writing 90H to the CUI places the device into Intelligent Identifier read mode. A read of location 00000H outputs the manufacturer's identification code, 0089H, and location 00001H outputs the device code; 2274H for A28F200BX-T, 2275H for A28F200BX-B. When BYTE# is at a logic low only the lower byte of the above signatures is read and DQ₁₅/A₋₁ is a "don't care" during Intelligent Identifier mode. A read array command must be written to the CUI to return to the read array mode.

3.3 Write Operations

Commands are written to the CUI using standard microprocessor write timings. The CUI serves as the interface between the microprocessor and the internal chip operation. The CUI can decipher Read Array, Read Intelligent Identifier, Read Status Register, Clear Status Register, Erase and Program commands. In the event of a read command, the CUI simply points the read path at either the array, the Intelligent Identifier, or the status register depending on the specific read command given. For a program or erase cycle, the CUI informs the write state machine that a write or erase has been requested. During a program cycle, the Write State Machine will control the program sequences and the CUI will only respond to status reads. During an erase cycle, the CUI will respond to status reads and erase suspend. After the Write State Machine has completed its task, it will allow the CUI to respond to its full command set. The CUI will stay in the current command state until the microprocessor issues another command.

The CUI will successfully initiate an erase or write operation only when V_{PP} is within its voltage range.

Depending upon the application, the system designer may choose to make the V_{PP} power supply switchable, available only when memory updates are desired. The system designer can also choose to "hard-wire" V_{PP} to 12V. The 2-Mbit boot block flash family is designed to accommodate either design practice. It is strongly recommended that RP# be tied to logical Reset for data protection during unstable CPU reset function as described in the "Product Family Overview" section.

3.3.1 BOOT BLOCK WRITE OPERATIONS

In the case of Boot Block modifications (write and erase), RP# is set to V_{HH} = 12V typically, in addition to V_{PP} at high voltage. However, if RP# is not at V_{HH} when a program or erase operation of the boot block is attempted, the corresponding status register bit (Bit 4 for Program and Bit 5 for Erase, refer to Table 4 for Status Register Definitions) is set to indicate the failure to complete the operation.

3.3.2 COMMAND USER INTERFACE (CUI)

The Command User Interface (CUI) serves as the interface to the microprocessor. The CUI points the read/write path to the appropriate circuit block as described in the previous section. After the WSM has completed its task, it will set the WSM Status bit to a "1", which will also allow the CUI to respond to its full command set. Note that after the WSM has returned control to the CUI, the CUI will remain in its current state.

3.3.2.1 Command Set

Command Codes	Device Mode
00	Invalid/Reserved
10	Alternate Program Setup
20	Erase Setup
40	Program Setup
50	Clear Status Register
70	Read Status Register
90	Intelligent Identifier
B0	Erase Suspend
D0	Erase Resume/Erase Confirm
FF	Read Array

3.3.2.2 Command Function Descriptions

Device operations are selected by writing specific commands into the CUI. Table 3 defines the 2-Mbit boot block flash family commands.

Table 3. Command Definitions

Command	Bus Cycles Req'd	Notes	First Bus Cycle			Second Bus Cycle		
			Operation	Address	Data	Operation	Address	Data
Read Array/Reset	1	1	Write	X	FFH			
Intelligent Identifier	3	2, 4	Write	X	90H	Read	IA	IID
Read Status Register	2	3	Write	X	70H	Read	X	SRD
Clear Status Register	1		Write	X	50H			
Erase Setup/Erase Confirm	2	5	Write	BA	20H	Write	BA	D0H
Word/Byte Write Setup/Write	2	6, 7	Write	WA	40H	Write	WA	WD
Erase Suspend/Erase Resume	2		Write	X	B0H	Write	X	D0H
Alternate Word/Byte Write Setup/Write	2	6, 7	Write	WA	10H	Write	WA	WD

NOTES:

1. Bus operations are defined in Tables 1, 2.
2. IA = Identifier Address: 00H for manufacturer code, 01H for device code.
3. SRD = Data read from Status Register.
4. IID = Intelligent Identifier Data.
- Following the Intelligent Identifier Command, two read operations access manufacturer and device codes.
5. BA = Address within the block being erased.
6. PA = Address to be programmed.
- PD = Data to be programmed at location PA.
7. Either 40H or 10H command is valid.
8. When writing commands to the device, the upper data bus [DQ8–DQ15] = X which is either V_{CC} or V_{SS} to avoid burning additional current.

Invalid/Reserved

These are unassigned commands. It is not recommended that the customer use any command other than the valid commands specified above. Intel reserves the right to redefine these codes for future functions.

Read Array (FFH)

This single write command points the read path at the array. If the host CPU performs a CE#/OE# controlled read immediately following a two-write sequence that started the WSM, then the device will output status register contents. If the Read Array command is given after Erase Setup the device is reset to read the array. A two Read Array command sequence (FFH) is required to reset to Read Array after Program Setup.

Intelligent Identifier (90H)

After this command is executed, the CUI points the output path to the Intelligent Identifier circuits. Only Intelligent Identifier values at addresses 0 and 1 can be read (only address A0 is used in this mode, all other address inputs are ignored).

Read Status Register (70H)

This is one of the two commands that is executable while the state machine is operating. After this command is written, a read of the device will output the contents of the status register, regardless of the address presented to the device.

The device automatically enters this mode after program or erase has completed.

Clear Status Register (50H)

The WSM can only set the Program Status and Erase Status bits in the status register, it can not clear them. Two reasons exist for operating the status register in this fashion. The first is a synchronization. The WSM does not know when the host CPU has read the status register, therefore it would not know when to clear the status bits. Secondly, if the CPU is programming a string of bytes, it may be more efficient to query the status register after programming the string. Thus, if any errors exist while programming the string, the status register will return the accumulated error status.

Program Setup (40H or 10H)

This command simply sets the CUI into a state such that the next write will load the address and data registers. Either 40H or 10H can be used for Program Setup. Both commands are included to accommodate efforts to achieve an industry standard command code set.

Program

The second write after the program setup command, will latch addresses and data. Also, the CUI initiates the WSM to begin execution of the program algorithm. While the WSM finishes the algorithm, the device will output Status Register contents. Note that the WSM cannot be suspended during programming.

Erase Setup (20H)

Prepares the CUI for the Erase Confirm command. No other action is taken. If the next command is not an Erase Confirm command then the CUI will set both the Program Status and Erase Status bits of the Status Register to a "1", place the device into the Read Status Register state, and wait for another command.

Erase Confirm (D0H)

If the previous command was an Erase Setup command, then the CUI will enable the WSM to erase, at the same time closing the address and data latches, and respond only to the Read Status Register and Erase Suspend commands. While the WSM is executing, the device will output Status Register data when OE# is toggled low. Status Register data can only be updated by toggling either OE# or CE# low.

Erase Suspend (B0H)

This command only has meaning while the WSM is executing an Erase operation, and therefore will only be responded to during an erase operation. After this command has been executed, the CUI will set an output that directs the WSM to suspend Erase operations, and then return to responding to only Read Status Register or to the Erase Resume commands. Once the WSM has reached the Suspend state, it will set an output into the CUI which allows the CUI to respond to the Read Array, Read Status Register, and Erase Resume commands. In this mode, the CUI will not respond to any other commands. The WSM will also set the WSM Status bit to a "1". The WSM will continue to run, idling in the SUSPEND state, regardless of the state of all input

control pins, with the exclusion of RP#. RP# will immediately shut down the WSM and the remainder of the chip. During a suspend operation, the data and address latches will remain closed, but the address pads are able to drive the address into the read path.

Erase Resume (D0H)

This command will cause the CUI to clear the Suspend state and set the WSM Status bit to a "0", but only if an Erase Suspend command was previously issued. Erase Resume will not have any effect in all other conditions.

3.3.3 STATUS REGISTER

The 2-Mbit boot block flash family contains a status register which may be read to determine when a program or erase operation is complete, and whether that operation completed successfully. The status register may be read at any time by writing the Read Status command to the CUI. After writing this command, all subsequent Read operations output data from the status register until another command is written to the CUI. A Read Array command must be written to the CUI to return to the Read Array mode.

The status register bits are output on DQ[0:7] whether the device is in the byte-wide (x8) or word-wide (x16) mode. In the word-wide mode the upper byte, DQ[8:15] is set to 00H during a Read Status command. In the byte-wide mode, DQ[8:14] are tristated and DQ15/A-1 retains the low order address function.

It should be noted that the contents of the status register are latched on the falling edge of OE# or CE# whichever occurs last in the read cycle. This prevents possible bus errors which might occur if the contents of the status register change while reading the status register. CE# or OE# must be toggled with each subsequent status read, or the completion of a program or erase operation will not be evident.

The Status Register is the interface between the microprocessor and the Write State Machine (WSM). When the WSM is active, this register will indicate the status of the WSM, and will also hold the bits indicating whether or not the WSM was successful in performing the desired operation. The WSM sets status bits "Three" through "Seven" and clears bits "Six" and "Seven", but cannot clear status bits "Three" through "Five". These bits can only be cleared by the controlling CPU through the use of the Clear Status Register command.

3.3.3.1 Status Register Bit Definition

Table 4. Status Register Definitions

WSMS	ESS	ES	PS	VPPS	R	R	R
7	6	5	4	3	2	1	0
<p>SR.7 = WRITE STATE MACHINE STATUS 1 = Ready 0 = Busy</p>				<p>NOTES: Write State Machine Status bit must first be checked to determine byte/word program or block erase completion, before the Program or Erase Status bits are checked for success.</p>			
<p>SR.6 = ERASE SUSPEND STATUS 1 = Erase Suspended 0 = Erase in Progress/Completed</p>				<p>When Erase Suspend is issued, WSM halts execution and sets both WSMS and ESS bits to "1". ESS bit remains set to "1" until an Erase Resume command is issued.</p>			
<p>SR.5 = ERASE STATUS 1 = Error in Block Erasure 0 = Successful Block Erase</p>				<p>When this bit is set to "1", WSM has applied the maximum number of erase pulses to the block and is still unable to successfully perform an erase verify.</p>			
<p>SR.4 = PROGRAM STATUS 1 = Error in Byte/Word Program 0 = Successful Byte/Word Program</p>				<p>When this bit is set to "1", WSM has attempted but failed to Program a byte or word.</p>			
<p>SR.3 = V_{PP} STATUS 1 = V_{PP} Low Detect; Operation Abort 0 = V_{PP} OK</p>				<p>The V_{PP} Status bit, unlike an A/D converter, does not provide continuous indication of V_{PP} level. The WSM interrogates the V_{PP} level only after the byte write or block erase command sequences have been entered and informs the system if V_{PP} has not been switched on. The V_{PP} Status bit is not guaranteed to report accurate feedback between V_{PP}_L and V_{PP}_H.</p>			
<p>SR.2–SR.0 = RESERVED FOR FUTURE ENHANCEMENTS</p>				<p>These bits are reserved for future use and should be masked out when polling the Status Register.</p>			

3.3.3.2 Clearing the Status Register

Certain bits in the status register are set by the write state machine, and can only be reset by the system software. These bits can indicate various failure conditions. By allowing the system software to control the resetting of these bits, several operations may be performed (such as cumulatively programming several bytes or erasing multiple blocks in sequence). The status register may then be read to determine if an error occurred during that programming or erasure series. This adds flexibility to the way the device may be programmed or erased. To clear the status register, the Clear Status Register command is written to the CUI. Then, any other command may be issued to the CUI. Note again that before a read cycle can be initiated, a Read Array command must be written to the CUI to specify whether the read data is to come from the array, status register, or Intelligent Identifier.

3.3.4 PROGRAM MODE

Program is executed by a two-write sequence. The Program Setup command is written to the CUI followed by a second write which specifies the address and data to be programmed. The write state machine will execute a sequence of internally timed events to:

1. Program the desired bits of the addressed memory word (byte), and
2. Verify that the desired bits are sufficiently programmed

Programming of the memory results in specific bits within a byte or word being changed to a "0".

If the user attempts to program "1"s, there will be no change of the memory cell content and no error occurs.

Similar to erasure, the status register indicates whether programming is complete. While the program sequence is executing, bit 7 of the status register is a "0". The status register can be polled by

toggling either CE # or OE # to determine when the program sequence is complete. Only the Read Status Register command is valid while programming is active.

When programming is complete, the status bits, which indicate whether the program operation was successful, should be checked. If the programming operation was unsuccessful, Bit 4 of the status register is set to a “1” to indicate a Program Failure. If Bit 3 is set then V_{PP} was not within acceptable limits, and the WSM will not execute the programming sequence.

The status register should be cleared before attempting the next operation. Any CUI instruction can follow after programming is completed; however, it must be recognized that reads from the memory, status register, or Intelligent Identifier cannot be accomplished until the CUI is given the appropriate command. A Read Array command must first be given before memory contents can be read.

Figure 6 shows a system software flowchart for device byte programming operation. Figure 7 shows a similar flowchart for device word programming operation (A28F200BX-only).

3.3.5 ERASE MODE

Erasure of a single block is initiated by writing the Erase Setup and Erase Confirm commands to the CUI, along with the addresses, A[12:16], identifying the block to be erased. These addresses are latched internally when the Erase Confirm command is issued. Block erasure results in all bits within the block being set to “1”.

The WSM will execute a sequence of internally timed events to:

1. Program all bits within the block
2. Verify that all bits within the block are sufficiently programmed
3. Erase all bits within the block and
4. Verify that all bits within the block are sufficiently erased

While the erase sequence is executing, Bit 7 of the status register is a “0”.

When the status register indicates that erasure is complete, the status bits, which indicate whether the erase operation was successful, should be checked. If the erasure operation was unsuccessful, Bit 5 of the status register is set to a “1” to indicate an Erase Failure. If V_{PP} was not within acceptable limits after the Erase Confirm command is issued, the WSM will not execute an erase sequence; instead, Bit 5 of the status register is set to a “1” to indicate

an Erase Failure, and Bit 3 is set to a “1” to identify that V_{PP} supply voltage was not within acceptable limits.

The status register should be cleared before attempting the next operation. Any CUI instruction can follow after erasure is completed; however, it must be recognized that reads from the memory array, status register, or Intelligent Identifier can not be accomplished until the CUI is given the appropriate command. A Read Array command must first be given before memory contents can be read.

Figure 8 shows a system software flowchart for Block Erase operation.

3.3.5.1 Suspending and Resuming Erase

Since an erase operation typically requires 1.5 to 3 seconds to complete, an Erase Suspend command is provided. This allows erase-sequence interruption in order to read data from another block of the memory. Once the erase sequence is started, writing the Erase Suspend command to the CUI requests that the Write State Machine (WSM) pause the erase sequence at a predetermined point in the erase algorithm. The status register must be read to determine when the erase operation has been suspended.

At this point, a Read Array command can be written to the CUI in order to read data from blocks other than that which is being suspended. The only other valid command at this time is the Erase Resume command or Read Status Register operation.

Figure 9 shows a system software flowchart detailing the operation.

During Erase Suspend mode, the chip can go into a pseudo-standby mode by taking CE # to V_{IH} and the active current is now a maximum of 10 mA. If the chip is enabled while in this mode by taking CE # to V_{IL}, the Erase Resume command can be issued to resume the erase operation.

Upon completion of reads from any block other than the block being erased, the Erase Resume command must be issued. When the Erase Resume command is given, the WSM will continue with the erase sequence and complete erasing the block. As with the end of erase, the status register must be read, cleared, and the next instruction issued in order to continue.

3.4.6 EXTENDED CYCLING

Intel has designed extended cycling capability into its ETOX III flash memory technology. The 2-Mbit boot block flash family is designed for 1,000 program/erase cycles on each of the five blocks. The combination of low electric fields, clean oxide processing and minimized oxide area per memory cell subjected to the tunneling electric field, results in very high cycling capability.

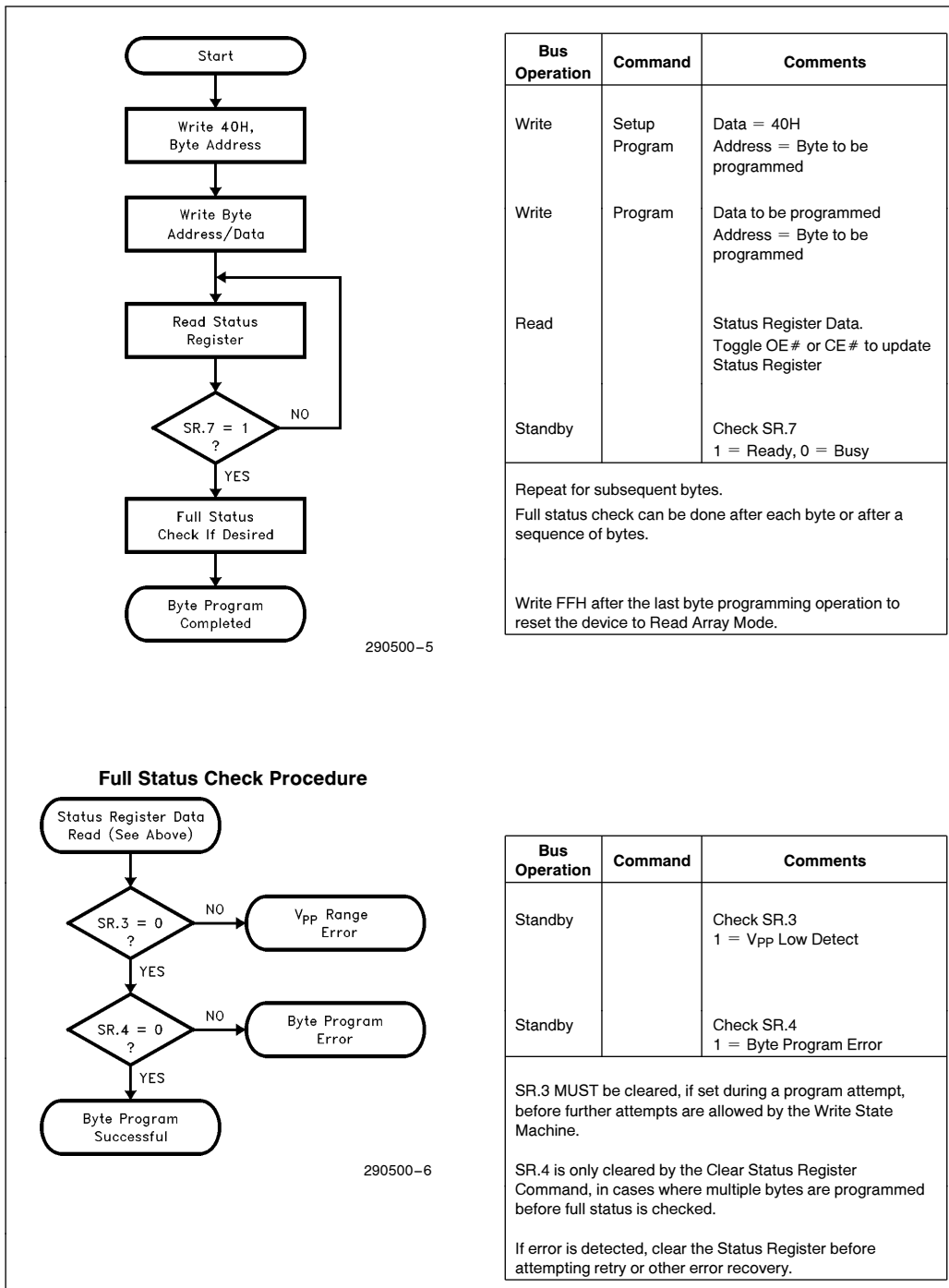

Figure 6. Automated Byte Programming Flowchart

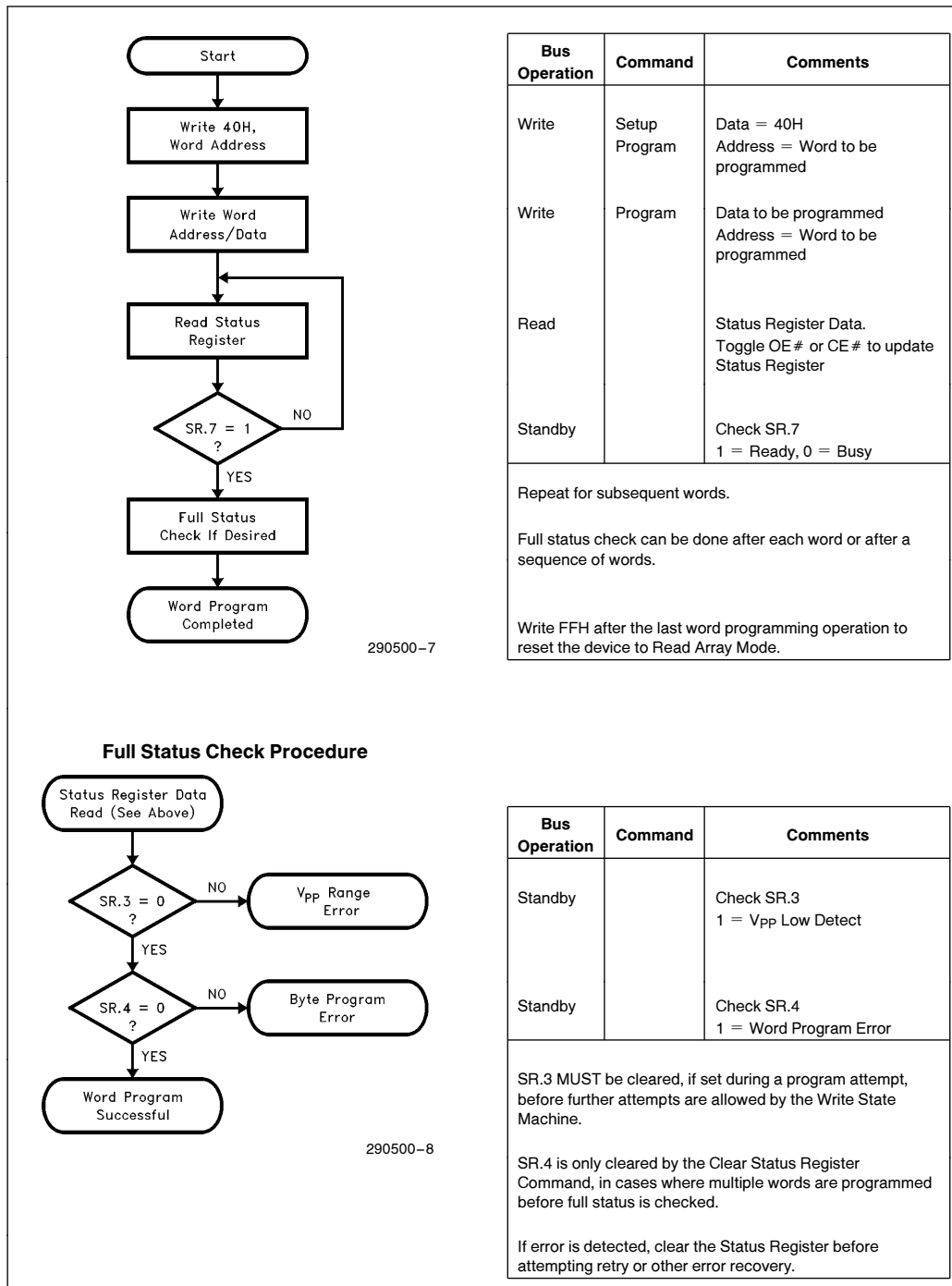

Figure 7. Automated Word Programming Flowchart

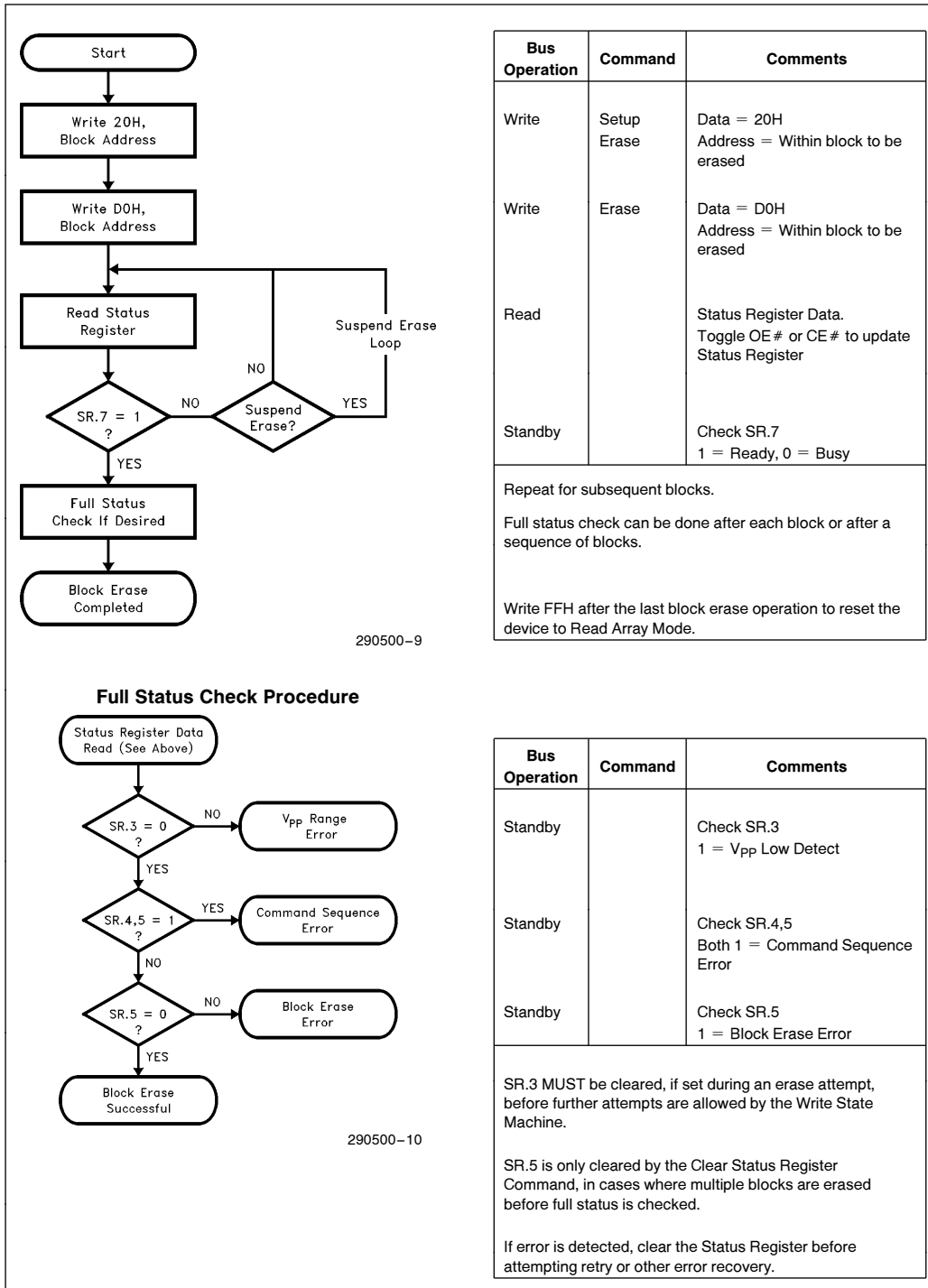

Figure 8. Automated Block Erase Flowchart

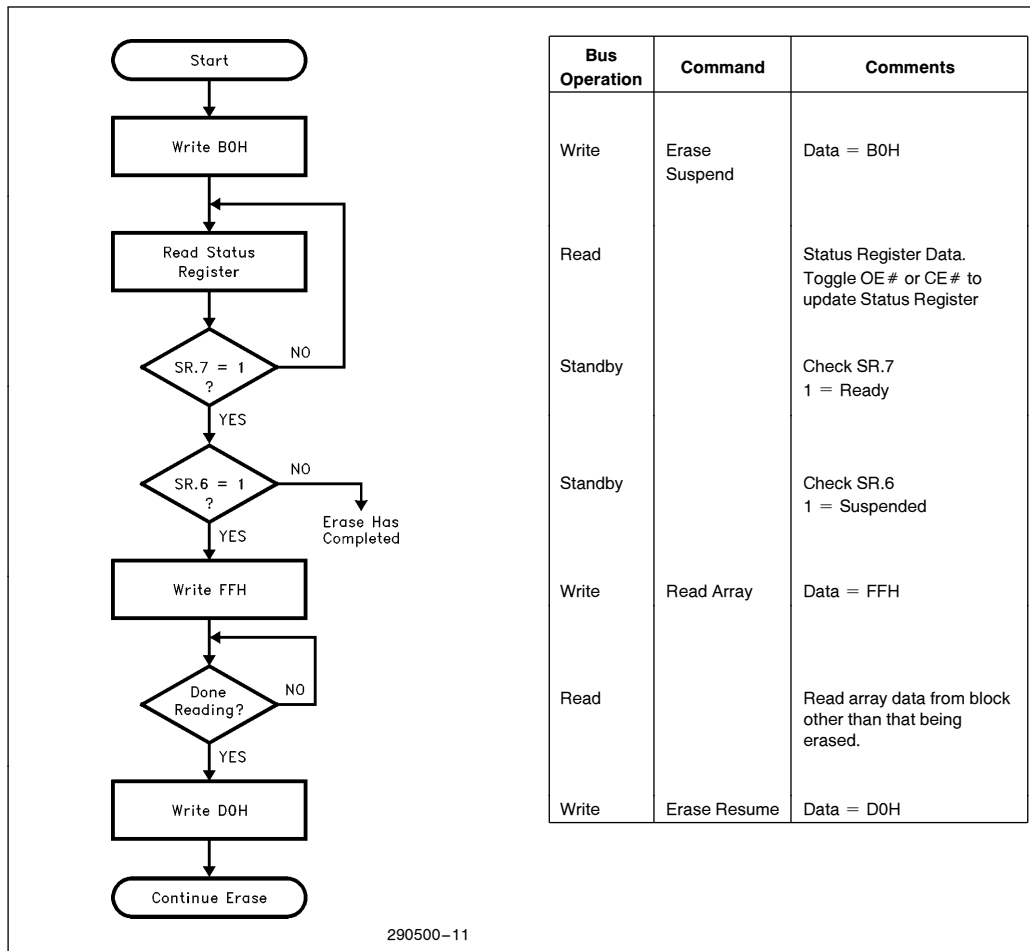

Figure 9. Erase Suspend/Resume Flowchart

3.4 Power Consumption

3.4.1 ACTIVE POWER

With CE# at a logic-low level and RP# at a logic-high level, the device is placed in the active mode. The device I_{CC} current is a maximum of 65 mA at 10 MHz with TTL input signals.

3.4.2 AUTOMATIC POWER SAVINGS

Automatic Power Savings (APS) is a low power feature during active mode of operation. The 2-Mbit family of products incorporate Power Reduction Control (PRC) circuitry which basically allows the device to put itself into a low current state when it is not being accessed. After data is read from the memory array, PRC logic controls the device's power consumption by entering the APS mode where

maximum I_{CC} current is 3 mA and typical I_{CC} current is 1 mA. The device stays in this static state with outputs valid until a new location is read.

3.4.3 STANDBY POWER

With CE# at a logic-high level (V_{IH}), and the CUI in read mode, the memory is placed in standby mode where the maximum I_{CC} standby current is 100 μA with CMOS input signals. The standby operation disables much of the device's circuitry and substantially reduces device power consumption. The outputs (DQ[0:15] or DQ[0:7]) are placed in a high-impedance state independent of the status of the OE# signal. When the 2-Mbit boot block flash family is deselected during erase or program functions, the devices will continue to perform the erase or program function and consume program or erase active power until program or erase is completed.

3.4.4 RESET/DEEP POWER-DOWN

The 2-Mbit boot block flash family has a RP# pin which places the device in the deep power-down mode. When RP# is at a logic-low ($GND \pm 0.2V$), all circuits are turned off and the device typically draws a maximum 80 μA of V_{CC} current.

During read modes, the RP# pin going low deselects the memory and places the output drivers in a high impedance state. Recovery from the deep power-down state, requires a minimum of 300 ns to access valid data (t_{PHQV}).

During erase or program modes, RP# low will abort either erase or program operation. The contents of the memory are no longer valid as the data has been corrupted by the RP# function. As in the read mode above, all internal circuitry is turned off to achieve the low current level.

RP# transitions to V_{IL} or turning power off to the device will clear the status register.

This use of RP# during system reset is important with automated write/erase devices. When the system comes out of reset it expects to read from the flash memory. Automated flash memories provide status information when accessed during write/erase modes. If a CPU reset occurs with no flash memory reset, proper CPU initialization would not occur because the flash memory would be providing the status information instead of array data. Intel's Flash Memories allow proper CPU initialization following a system reset through the use of the RP# input. In this application RP# is controlled by the same RESET# signal that resets the system CPU.

3.5 Power-Up Operation

The 2-Mbit boot block flash family is designed to offer protection against accidental block erasure or programming during power transitions. Upon power-up the 2-Mbit boot block flash family is indifferent as to which power supply, V_{PP} or V_{CC} , powers-up first. Power supply sequencing is not required.

The 2-Mbit boot block flash family ensures the CUI is reset to the read mode on power-up.

In addition, on power-up the user must either drop CE# low or present a new address to ensure valid data at the outputs.

A system designer must guard against spurious writes for V_{CC} voltages above V_{LKO} when V_{PP} is active. Since both WE# and CE# must be low for a command write, driving either signal to V_{IH} will inhibit writes to the device. The CUI architecture provides an added level of protection since alteration of mem-

ory contents can only occur after successful completion of the two-step command sequences. Finally, the device is disabled until RP# is brought to V_{IH} , regardless of the state of its control inputs. This feature provides yet another level of memory protection.

3.6 Power Supply Decoupling

Flash memory's power switching characteristics require careful device decoupling methods. System designers are interested in 3 supply current issues:

- Standby current levels (I_{CCS})
- Active current levels (I_{CCR})
- Transient peaks produced by falling and rising edges of CE#.

Transient current magnitudes depend on the device outputs' capacitive and inductive loading. Two-line control and proper decoupling capacitor selection will suppress these transient voltage peaks. Each flash device should have a 0.1 μF ceramic capacitor connected between each V_{CC} and GND, and between its V_{PP} and GND. These high frequency, low-inductance capacitors should be placed as close as possible to the package leads.

3.6.1 V_{PP} TRACE ON PRINTED CIRCUIT BOARDS

Writing to flash memories while they reside in the target system, requires special consideration of the V_{PP} power supply trace by the printed circuit board designer. The V_{PP} pin supplies the flash memory cell's current for programming and erasing. One should use similar trace widths and layout considerations given to the V_{CC} power supply trace. Adequate V_{PP} supply traces and decoupling will decrease spikes and overshoots.

3.6.2 V_{CC} , V_{PP} AND RP# TRANSITIONS

The CUI latches commands as issued by system software and is not altered by V_{PP} or CE# transitions or WSM actions. Its state upon power-up, after exit from deep power-down mode or after V_{CC} transitions below V_{LKO} (Lockout voltage), is Read Array mode.

After any word/byte write or block erase operation is complete and even after V_{PP} transitions down to V_{PPL} , the CUI must be reset to Read Array mode via the Read Array command when accesses to the flash memory are desired.



ABSOLUTE MAXIMUM RATINGS*

- Automatic Operating Temperature
 - During Read -40°C to +125°C
 - During Block Erase and Word/Byte Write -40°C to +125°C
 - Temperature Under Bias -40°C to +125°C
- Storage Temperature -65°C to +150°C
- Voltage on Any Pin (except V_{CC}, A₉, V_{PP} and RP#) with Respect to GND -2.0V to +7.0V(2)
- Voltage on Pin RP# or Pin A₉ with Respect to GND -2.0V to +13.5V(2, 3)
- V_{PP} Program Voltage with Respect to GND during Block Erase and Word/Byte Write -2.0V to +14.0V(2, 3)
- V_{CC} Supply Voltage with Respect to GND -2.0V to +7.0V(2)
- Output Short Circuit Current 100 mA(4)

NOTICE: This data sheet contains information on products in the sampling and initial production phases of development. The specifications are subject to change without notice. Verify with your local Intel Sales office that you have the latest data sheet before finalizing a design.

**WARNING: Stressing the device beyond the "Absolute Maximum Ratings" may cause permanent damage. These are stress ratings only. Operation beyond the "Operating Conditions" is not recommended and extended exposure beyond the "Operating Conditions" may affect device reliability.*

NOTES:

1. Operating temperature is for automotive product defined by this specification.
2. Minimum DC voltage is -0.5V on input/output pins. During transitions, this level may undershoot to -2.0V for periods <20 ns. Maximum DC voltage on input/output pins is V_{CC} + 0.5V which, during transitions, may overshoot to V_{CC} + 2.0V for periods <20 ns.
3. Maximum DC voltage on V_{PP} may overshoot to +14.0V for periods <20 ns. Maximum DC voltage on RP# or A₉ may overshoot to 13.5V for periods <20 ns.
4. Output shorted for no more than one second. No more than one output shorted at a time.

OPERATING CONDITIONS

Symbol	Parameter	Notes	Min	Max	Units
T _A	Operating Temperature		-40	125	°C
V _{CC}	V _{CC} Supply Voltage (10%)	5	4.50	5.50	V

DC CHARACTERISTICS

Symbol	Parameter	Notes	Min	Typ	Max	Unit	Test Condition
I _{LI}	Input Load Current	1			±1.0	μA	V _{CC} = V _{CC} Max V _{IN} = V _{CC} or GND
I _{LO}	Output Leakage Current	1			±10	μA	V _{CC} = V _{CC} Max V _{OUT} = V _{CC} or GND
I _{CCS}	V _{CC} Standby Current	1, 3			1.5	mA	V _{CC} = V _{CC} Max CE# = RP# = V _{IH}
					130	μA	V _{CC} = V _{CC} Max CE# = RP# = V _{CC} ±0.2V A28F200BX: BYTE# = V _{CC} ±0.2V or GND

DC CHARACTERISTICS (Continued)

Symbol	Parameter	Notes	Min	Typ	Max	Unit	Test Condition
I _{CCD}	V _{CC} Deep Power-Down Current	1			80	μA	RP# = GND ±0.2V
I _{CCR}	V _{CC} Read Current for A28F200BX Byte-Wide and Word-Wide Mode	1, 5, 6			60	mA	V _{CC} = V _{CC} Max, CE# = GND f = 10 MHz, I _{OUT} = 0 mA CMOS Inputs
					65	mA	V _{CC} = V _{CC} Max, CE# = V _{IL} f = 10 MHz, I _{OUT} = 0 mA TTL Inputs
I _{CCW}	V _{CC} Write Current	1, 4			65	mA	Word Write in Progress
I _{CCE}	V _{CC} Block Erase Current	1, 4			30	mA	Block Erase in Progress
I _{CCES}	V _{CC} Erase Suspend Current	1, 2		5	10	mA	Block Erase Suspended, CE# = V _{IH}
I _{PPS}	V _{PP} Standby Current	1			15	μA	V _{PP} ≤ V _{CC}
I _{PPD}	V _{PP} Deep Power-Down Current	1			5.0	μA	RP# = GND ±0.2V
I _{PPR}	V _{PP} Read Current	1			200	μA	V _{PP} > V _{CC}
I _{PPW}	V _{PP} Word Write Current	1, 4			40	mA	V _{PP} = V _{PPH} Word Write in Progress
I _{PPW}	V _{PP} Byte Write Current	1, 4			30	mA	V _{PP} = V _{PPH} Byte Write in Progress
I _{PPE}	V _{PP} Block Erase Current	1, 4			30	mA	V _{PP} = V _{PPH} Block Erase in Progress
I _{PPES}	V _{PP} Erase Suspend Current	1			200	μA	V _{PP} = V _{PPH} Block Erase Suspended
I _{RP#}	RP# Current	1, 4			500	μA	RP# = V _{HH}
I _{ID}	A ₉ Intelligent Identifier Current	1, 4			500	μA	A ₉ = V _{ID}
V _{ID}	A ₉ Intelligent Identifier Voltage		11.5		13.0	V	
V _{IL}	Input Low Voltage		-0.5		0.8	V	
V _{IH}	Input High Voltage		2.0		V _{CC} + 0.5	V	
V _{OL}	Output Low Voltage				0.45	V	V _{CC} = V _{CC} Min I _{OL} = 5.8 mA
V _{OH}	Output High Voltage		2.4			V	V _{CC} = V _{CC} Min I _{OH} = -2.5 mA
V _{PPPL}	V _{PP} during Normal Operations	3	0.0		6.5	V	
V _{PPPH}	V _{PP} during Erase/Write Operations	7	11.4	12.0	12.6	V	
V _{LKO}	V _{CC} Erase/Write Lock Voltage		2.0			V	
V _{HH}	RP# Unlock Voltage		11.5		13.0	V	Boot Block Write/Erase

CAPACITANCE(4) $T_A = 25^\circ\text{C}$, $f = 1\text{ MHz}$

Symbol	Parameter	Typ	Max	Unit	Condition
C_{IN}	Input Capacitance	6	8	pF	$V_{IN} = 0V$
C_{OUT}	Output Capacitance	10	12	pF	$V_{OUT} = 0V$

NOTES:

1. All currents are in RMS unless otherwise noted. Typical values at $V_{CC} = 5.0V$, $V_{PP} = 12.0V$, $T = 25^\circ\text{C}$. These currents are valid for all product versions (packages and speeds).
2. I_{CCES} is specified with the device deselected. If the device is read while in Erase Suspend Mode, current draw is the sum of I_{CCES} and I_{CCR} .
3. Block Erases and Word/Byte Writes are inhibited when $V_{PP} = V_{PPL}$ and not guaranteed in the range between V_{PPH} and V_{PPL} .
4. Sampled, not 100% tested.
5. Automatic Power Savings (APS) reduces I_{CCR} to less than 1 mA typical in static operation.
6. CMOS Inputs are either $V_{CC} \pm 0.2V$ or $GND \pm 0.2V$. TTL Inputs are either V_{IL} or V_{IH} .
7. $V_{PP} = 12.0V \pm 5\%$ for applications requiring 1,000 block erase cycles.

STANDARD TEST CONFIGURATION

STANDARD AC INPUT/OUTPUT REFERENCE WAVEFORM

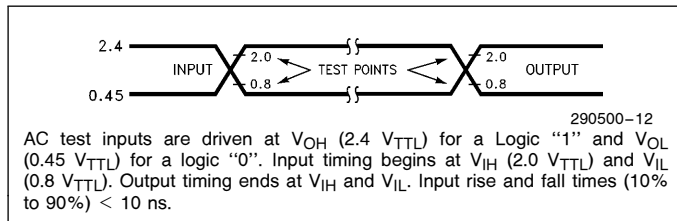

STANDARD AC TESTING LOAD CIRCUIT

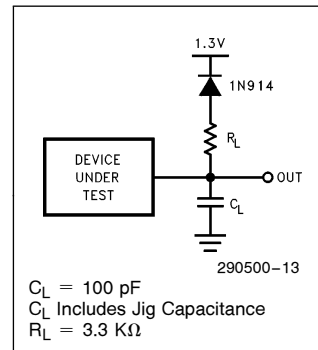

AC CHARACTERISTICS—Read Only Operations⁽¹⁾:

Symbol		Versions		A28F200BX-90 ⁽⁴⁾		Unit
		Parameter	Notes	Min	Max	
t _{AVAV}	t _{RC}	Read Cycle Time		90		ns
t _{AVQV}	t _{ACC}	Address to Output Delay			90	ns
t _{ELQV}	t _{CE}	CE # to Output Delay	2		90	ns
t _{PHQV}	t _{PWH}	RP # High to Output Delay			300	ns
t _{GLQV}	t _{OE}	OE # to Output Delay	2		45	ns
t _{ELQX}	t _{LZ}	CE # to Output Low Z	3	0		ns
t _{EHQZ}	t _{HZ}	CE # High to Output High Z	3		35	ns
t _{GLQX}	t _{OLZ}	OE # to Output Low Z	3	0		ns
t _{GHQZ}	t _{DF}	OE # High to Output High Z	3		35	ns
	t _{OH}	Output Hold from Addresses, CE # or OE # Change, Whichever is First	3	0		ns
t _{ELFL} t _{ELFH}		CE # to BYTE # Switching Low or High	3		5	ns
t _{FHQV}		BYTE # Switching High to Valid Output Delay	3, 5		90	ns
t _{FLQZ}		BYTE # Switching Low to Output High Z	3		35	ns

NOTES:

1. See AC Input/Output Reference Waveform for timing measurements.
2. OE # may be delayed up to t_{CE}-t_{OE} after the falling edge of CE # without impact on t_{CE}.
3. Sampled, not 100% tested.
4. See Standard Test Configuration.
5. t_{FLQV}, BYTE # switching low to valid output delay, will be equal to t_{AVQV}, measured from the time DQ₅/A₋₁ becomes valid.

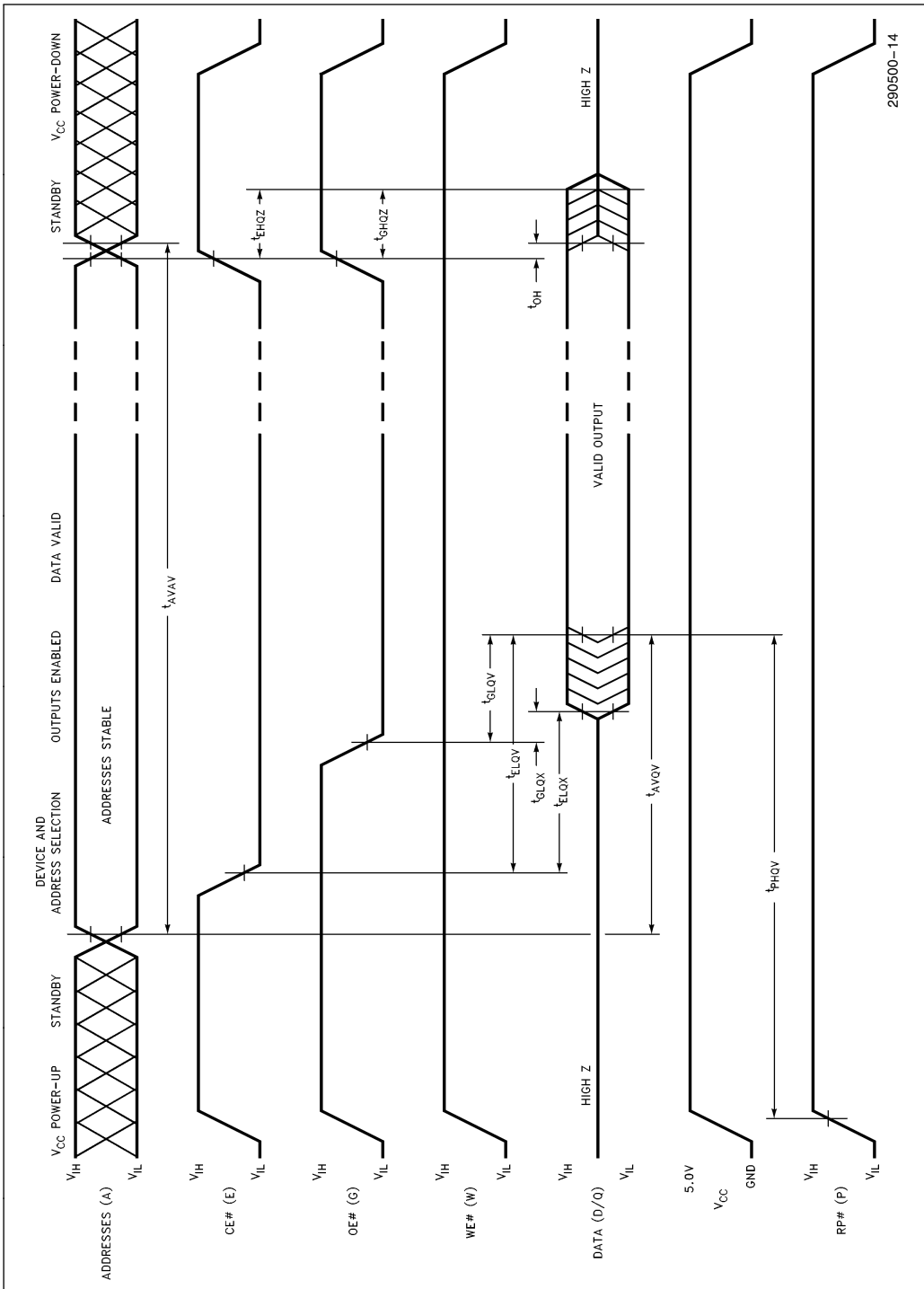
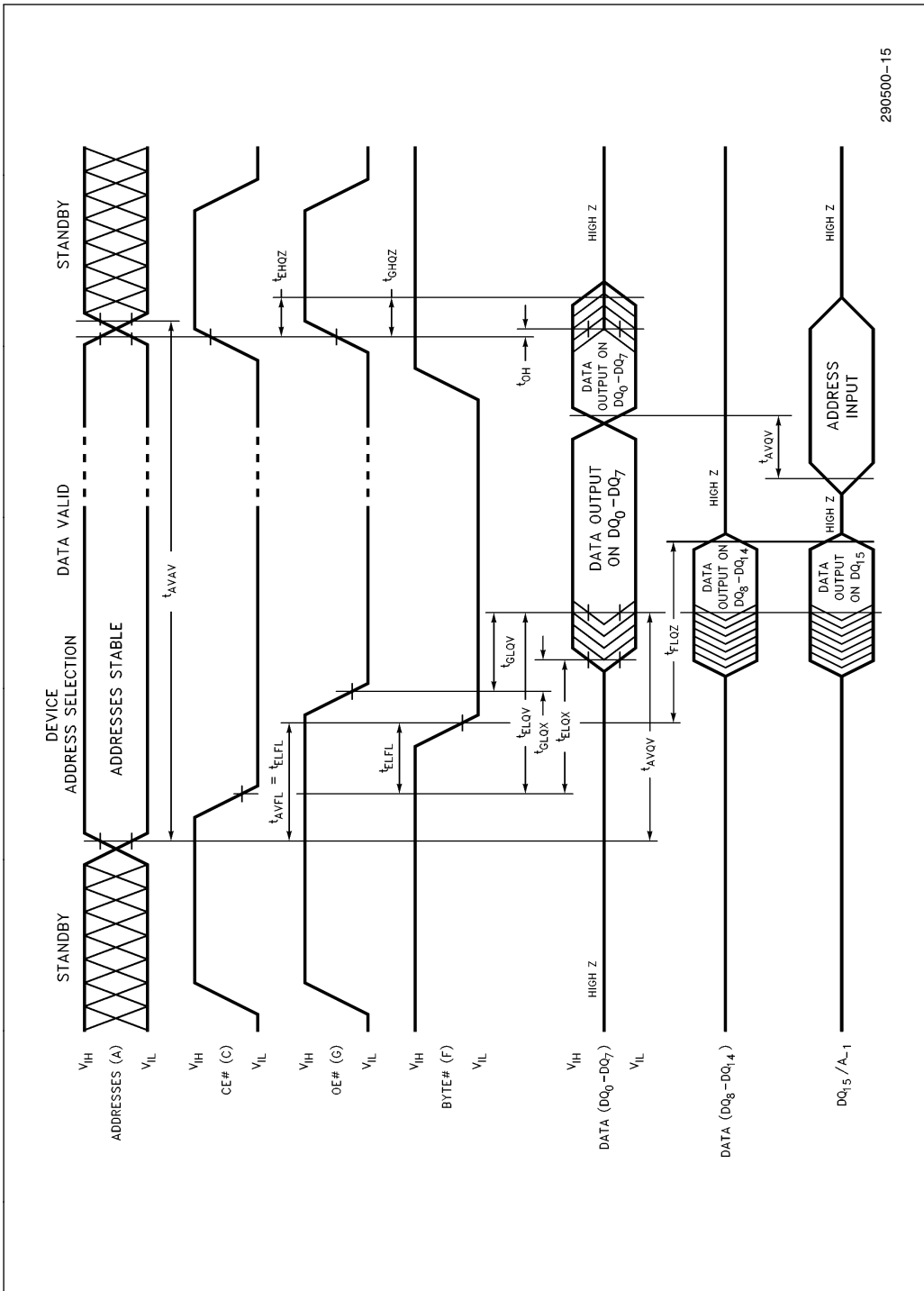

Figure 10. AC Waveforms for Read Operations



290500-15

Figure 11. BYTE# Timing for Both Read and Write Operations for A28F200BX

AC CHARACTERISTICS For WE #-Controlled Write Operations⁽¹⁾:

Versions ⁽⁴⁾			A28F200BX-90 ⁽⁹⁾		Unit
Symbol	Parameter	Notes	Min	Max	
t _{AVAV}	t _{WC}	Write Cycle Time	90		ns
t _{PHWL}	t _{PS}	RP# High Recovery to WE# Going Low	210		ns
t _{ELWL}	t _{CS}	CE# Setup to WE# Going Low	0		ns
t _{PHHWH}	t _{PHS}	RP# V _{HH} Setup to WE# Going High	6, 8	100	ns
t _{VPWH}	t _{VPS}	V _{PP} Setup to WE# Going High	5, 8	100	ns
t _{AVWH}	t _{AS}	Address Setup to WE# Going High	3	60	ns
t _{DVWH}	t _{DS}	Data Setup to WE# Going High	4	60	ns
t _{WLWH}	t _{WP}	WE# Pulse Width		60	ns
t _{WHDX}	t _{DH}	Data Hold from WE# High	4	0	ns
t _{WHAX}	t _{AH}	Address Hold from WE# High	3	10	ns
t _{WHEH}	t _{CH}	CE# Hold from WE# High		10	ns
t _{WHWL}	t _{WPH}	WE# Pulse Width High		30	ns
t _{WHQV1}		Duration of Word/Byte Write Operation	2, 5	7	μs
t _{WHQV2}		Duration of Erase Operation (Boot)	2, 5, 6	0.4	s
t _{WHQV3}		Duration of Erase Operation (Parameter)	2, 5	0.4	s
t _{WHQV4}		Duration of Erase Operation (Main)	2, 5, 6	0.7	s
t _{QWL}	t _{VPH}	V _{PP} Hold from Valid SRD	5, 8	0	ns
t _{QVPH}	t _{PHH}	RP# V _{HH} Hold from Valid SRD	6, 8	0	ns
t _{PHBR}		Boot-Block Relock Delay	7, 8	100	ns

NOTES:

1. Read timing characteristics during write and erase operations are the same as during read-only operations. Refer to AC Characteristics during Read Mode.
2. The on-chip WSM completely automates program/erase operations; program/erase algorithms are now controlled internally which includes verify and margining operations.
3. Refer to command definition table for valid A_{IN}.
4. Refer to command definition table for valid D_{IN}.
5. Program/Erase durations are measured to valid SRD data (successful operation, SR.7 = 1).
6. For Boot Block Program/Erase, RP# should be held at V_{HH} until operation completes successfully.
7. Time t_{PHBR} is required for successful relocking of the Boot Block.
8. Sampled but not 100% tested.
9. See Standard Test Configuration.

BLOCK ERASE AND WORD/BYTE WRITE PERFORMANCE: $V_{pp} = 12.0V \pm 5\%$

Parameter	Notes	A28F200BX-90			Unit
		Min	Typ(1)	Max	
Boot/Parameter Block Erase Time	2		1.5	10.5	s
Main Block Erase Time	2		3.0	18	s
Main Block Byte Program Time	2		1.4	5.0	s
Main Block Word Program Time	2		0.7	2.5	s

NOTES:

1. 25°C, 12.0V V_{pp} .
2. Excludes System-Level Overhead.

AC CHARACTERISTICS FOR CE #-CONTROLLED WRITE OPERATIONS(1, 9)

Versions			A28F200BX-90 ⁽¹⁰⁾		Unit
Symbol	Parameter	Notes	Min	Max	
t _{AVAV}	t _{WC}	Write Cycle Time	90		ns
t _{PHL}	t _{PS}	RP# High Recovery to CE# Going Low	210		ns
t _{WLEL}	t _{WS}	WE# Setup to CE# Going Low	0		ns
t _{PHHEH}	t _{PHS}	RP# V _{HH} Setup to CE# Going High	6, 8	100	ns
t _{VPEH}	t _{VPS}	V _{PP} Setup to CE# Going High	5, 8	100	ns
t _{AVEH}	t _{AS}	Address Setup to CE# Going High	3	60	ns
t _{DVEH}	t _{DS}	Data Setup to CE# Going High	4	60	ns
t _{ELEH}	t _{CP}	CE# Pulse Width		60	ns
t _{EHD}	t _{DH}	Data Hold from CE# High	4	0	ns
t _{EHA}	t _{AH}	Address Hold from CE# High	3	10	ns
t _{EHW}	t _{WH}	WE# Hold from CE# High		10	ns
t _{EHL}	t _{CPH}	CE# Pulse Width High		30	ns
t _{EHQV1}		Duration of Word/Byte Programming Operation	2, 5	7	μs
t _{EHQV2}		Duration of Erase Operation (Boot)	2, 5, 6	0.4	s
t _{EHQV3}		Duration of Erase Operation (Parameter)	2, 5	0.4	s
t _{EHQV4}		Duration of Erase Operation (Main)	2, 5	0.7	s
t _{QWL}	t _{VPH}	V _{PP} Hold from Valid SRD	5, 8	0	ns
t _{QVPH}	t _{PHH}	RP# V _{HH} Hold from Valid SRD	6, 8	0	ns
t _{PHBR}		Boot-Block Relock Delay	7		100 ns

NOTES:

1. Chip-Enable Controlled Writes: Write operations are driven by the valid combination of CE# and WE# in systems where CE# defines the write pulse-width (within a longer WE# timing waveform), all set-up, hold and inactive WE# time should be measured relative to the CE# waveform.

2, 3, 4, 5, 6, 7, 8: Refer to AC Characteristics for WE#-Controlled Write Operations.

9. Read timing characteristics during write and erase operations are the same as during read-only operations. Refer to AC Characteristics during Read Mode.

10. See Standard Test Configuration.

ORDERING INFORMATION

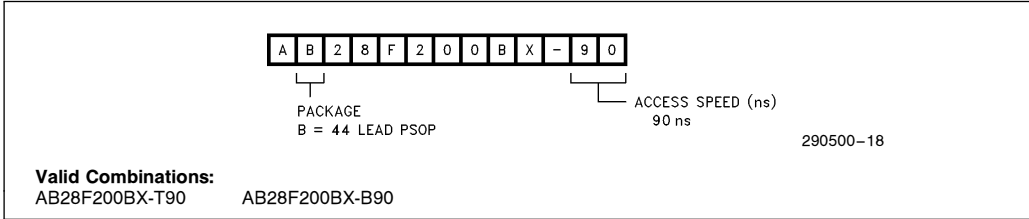

ADDITIONAL INFORMATION

Order Number

A28F400BX Datasheet	290501
28F400BX/28F004BX Datasheet	290451
A28F200BX-L/28F002BX-L Datasheet	290449
28F400BX-L/28F004BX-L Datasheet	290450
AP-363 "Extended Flash BIOS Design for Portable Computers"	292098
ER-28 "ETOX™ III Flash Memory Technology"	204012
ER-29 "The Intel 2/4-Mbit Boot Block Flash Memory Family"	294013

REVISION HISTORY

Number	Description
002	Changed Package Designator
003	Changed IppS