

Low  $I_Q$ , Low Dropout 150mA Fixed Voltage Regulator

## Features

- Low Noise :  $60\mu V_{RMS}$  (100Hz to 100kHz)
- Low Quiescent Current : 50uA
- Low Dropout Voltage : 300mV  
( $V_{OUT}(\text{Nominal})=3.0V$  Version @ 150mA)
- Very low Shutdown Current : < 0.5uA
- Fixed Output Voltage : 1.3V,1.4V,1.5V,1.6V, 1.7V,1.8V,1.9V, 2.0V,2.1V,2.2V,2.3V,2.4V, 2.5V,2.6V,2.7V, 2.8V, 2.85V,2.9V,3.0V,3.1V, 3.2V,3.3V,3.4V, 3.5V, 5.0V
- Stable with 1uF Output Capacitor
- Stable with Aluminum , Tantalum or Ceramic Capacitors
- Reverse Current Protection
- No Protection Diodes Needed
- Built in Thermal Protection
- Built in Current Limit Protection
- Controlled Short Circuit Current : 50mA
- Fast transient Response
- Short Setting Time
- SOT-23-5 Package
- Lead Free Available (RoHS Compliant)

## General Description

The APL5151/2/3/4 is micropower, low noise, low dropout linear regulator. Operate from 3V to 6V input voltage and deliver up to 150mA. Typical output noise is just  $60\mu V_{RMS}$  with the addition of an external 0.33uF bypass capacitor in BP pin and typical dropout voltage is only 220mV at 150mA loading. Designed for use in battery-powered system, the low 50uA quiescent current makes it an ideal choice. Design with an internal P-channel MOSFET pass transistor, the APL5151/2/3/4 maintains a low supply current, independent of the load current and dropout voltage. Other features include reverse current protection, thermal-shutdown protection, current limit protection to ensure specified output current and controlled short-circuit current. The APL5151/2/3/4 regulators come in a miniature SOT-23-5 package.

## Pin Configuration

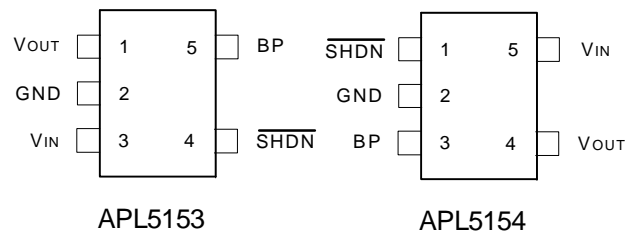
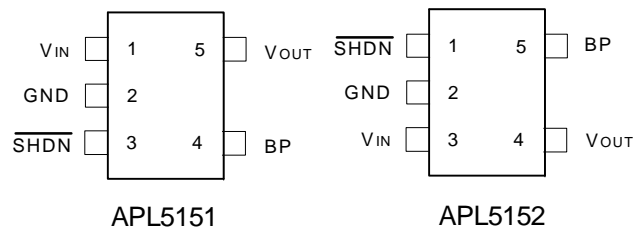

## Applications

- Notebook Computer
- PDA or Portable Equipments
- Noise-Sensitive Instrumentation Systems

ANPEC reserves the right to make changes to improve reliability or manufacturability without notice, and advise customers to obtain the latest version of relevant information to verify before placing orders.

## Ordering Information

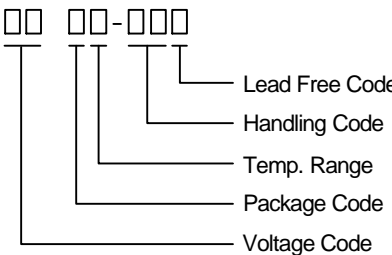
APL5151/2/3/4 - □□ □□-□□□□ 	Package Code B : SOT-23-5 Temp. Range C : 0 to 70°C                      I : -40 to 85°C Handling Code TR : Tape & Reel Voltage Code : 13 : 1.3V ~ 50 : 5.0V(refer below for detailed) Lead Free Code L : Lead Free Device              Blank : Original Device
---	--

Note: ANPEC lead-free products contain molding compounds/die attach materials and 100% matte in plate termination finish; which are fully compliant with RoHS and compatible with both SnPb and lead-free soldering operations. ANPEC lead-free products meet or exceed the lead-free requirements of IPC/JEDEC J STD-020C for MSL classification at lead-free peak reflow temperature.

## Marking Information

Product Name	Marking	Product Name	Marking	Product Name	Marking	Product Name	Marking
APL5151-13	1517X	APL5152-13	1527X	APL5153-13	1537X	APL5154-13	1547X
APL5151-14	1518X	APL5152-14	1528X	APL5153-14	1538X	APL5154-14	1548X
APL5151-15	1519X	APL5152-15	1529X	APL5153-15	1539X	APL5154-15	1549X
APL5151-16	151AX	APL5152-16	152AX	APL5153-16	153AX	APL5154-16	154AX
APL5151-17	151BX	APL5152-17	152BX	APL5153-17	153BX	APL5154-17	154BX
APL5151-18	151CX	APL5152-18	152CX	APL5153-18	153CX	APL5154-18	154CX
APL5151-19	151DX	APL5152-19	152DX	APL5153-19	153DX	APL5154-19	154DX
APL5151-20	151EX	APL5152-20	152EX	APL5153-20	153EX	APL5154-20	154EX
APL5151-21	151FX	APL5152-21	152FX	APL5153-21	153FX	APL5154-21	154FX
APL5151-22	151GX	APL5152-22	152GX	APL5153-22	153GX	APL5154-22	154GX
APL5151-23	151HX	APL5152-23	152HX	APL5153-23	153HX	APL5154-23	154HX
APL5151-24	151IX	APL5152-24	152IX	APL5153-24	153IX	APL5154-24	154IX
APL5151-25	151JX	APL5152-25	152JX	APL5153-25	153JX	APL5154-25	154JX
APL5151-26	151KX	APL5152-26	152KX	APL5153-26	153KX	APL5154-26	154KX
APL5151-27	151LX	APL5152-27	152LX	APL5153-27	153LX	APL5154-27	154LX
APL5151-28	151MX	APL5152-28	152MX	APL5153-28	153MX	APL5154-28	154MX
APL5151-285	1512X	APL5152-285	1522X	APL5153-285	1532X	APL5154-285	1542X
APL5151-29	151NX	APL5152-29	152NX	APL5153-29	153NX	APL5154-29	154NX
APL5151-30	151OX	APL5152-30	152OX	APL5153-30	153OX	APL5154-30	154OX
APL5151-31	151PX	APL5152-31	152PX	APL5153-31	153PX	APL5154-31	154PX
APL5151-32	151QX	APL5152-32	152QX	APL5153-32	153QX	APL5154-32	154QX
APL5151-33	151RX	APL5152-33	152RX	APL5153-33	153RX	APL5154-33	154RX
APL5151-34	151SX	APL5152-34	152SX	APL5153-34	153SX	APL5154-34	154SX
APL5151-35	151TX	APL5152-35	152TX	APL5153-35	153TX	APL5154-35	154TX
APL5151-48	151XX	APL5152-48	152XX	APL5153-48	153XX	APL5154-48	154XX
APL5151-49	151YX	APL5152-49	152YX	APL5153-49	153YX	APL5154-49	154YX
APL5151-50	151ZX	APL5152-50	152ZX	APL5153-50	153ZX	APL5154-50	154ZX

The last character "X" in the marking is for data code.

## Pin Description

PIN		I/O	Description
No.	Name		
1	V <sub>IN</sub>	I	Supply voltage input.
2	GND		Ground pins of the circuitry, and all ground pins must be soldered to PCB with proper power dissipation.
3	$\overline{\text{SHDN}}$	I	Shutdown control pin, low = off , high = normal .
4	BP	O	Bypass signal pin in fixed output type device
5	V <sub>OUT</sub>	O	Output pin of the regulator.

## Absolute Maximum Ratings

Symbol	Parameter	Rating	Unit
V <sub>IN</sub> , V <sub>OUT</sub>	Input Voltage or Out Voltage	6	V
$\overline{\text{SHDN}}$	Shutdown Control Pin	6	V
R <sub>TH,JA</sub>	Thermal Resistance – Junction to Ambient	260	°C/W
R <sub>TH,JC</sub>	Thermal Resistance – Junction to Case	130	°C/W
P <sub>D</sub>	Power Dissipation	Internally Limited	W
T <sub>J</sub>	Operating Junction Temperature Control Section Power Transistor	0 to 125 0 to 150	°C
T <sub>STG</sub>	Storage Temperature Range	-65 to +150	°C
T <sub>L</sub>	Lead Temperature (Soldering, 10 second)	260	°C

## Electrical Characteristics

Unless otherwise noted these specifications apply over full temperature , V<sub>IN</sub>=3.6V, C<sub>IN</sub>=C<sub>OUT</sub>=1uF, SHDN=V<sub>IN</sub>, T<sub>J</sub>=0 to 125°C . Typical values refer to T<sub>J</sub>=25°C .

Symbol	Parameter	Test Conditions	APL5151/2/3/4			Unit
			Min.	Typ.	Max.	
V <sub>IN</sub>	Input Voltage		2.7		6	V
V <sub>OUT</sub>	Output Voltage	V <sub>OUT</sub> +1.0V < V <sub>CC</sub> <6.0V, 0mA < I <sub>OUT</sub> < I <sub>MAX</sub>	V <sub>OUT</sub> -2%	V <sub>OUT</sub>	V <sub>OUT</sub> +2%	V
I <sub>LIMIT</sub>	Circuit Current Limit	V <sub>IN</sub> =V <sub>OUT</sub> +1V	250	300	350	mA
I <sub>SHORT</sub>	Short Current	V <sub>OUT</sub> =0V	40	50	60	mA
I <sub>OUT</sub>	Load Current		150			mA
REG <sub>LINE</sub>	Line Regulation	V <sub>OUT</sub> +0.5V < V <sub>CC</sub> <6.0V, 0mA < I <sub>OUT</sub> < I <sub>MAX</sub>		4	10	mV
REG <sub>LOAD</sub>	Load Regulation	V <sub>IN</sub> = V <sub>OUT</sub> +1.0V, 0mA < I <sub>OUT</sub> < I <sub>MAX</sub>		1	6	mV
	Load Transient	V <sub>IN</sub> = V <sub>OUT</sub> +1V , I <sub>OUT</sub> =1mA-150mA in 1μs		70	150	mV

## Electrical Characteristics (Cont.)

Unless otherwise noted these specifications apply over full temperature,  $V_{IN}=3.6V$ ,  $C_{IN}=C_{OUT}=1\mu F$ ,  $\overline{SHDN}=V_{IN}$ ,  $T_J=0$  to  $125^\circ C$ . Typical values refer to  $T_J=25^\circ C$ .

Symbol	Parameter	Test Conditions	APL5151/2/3/4			Unit	
			Min.	Typ.	Max.		
PSRR	Ripple Rejection	$F \leq 1kHz$ , 1Vpp at $V_{IN} = V_{OUT} + 1.0V$ $C_{BP} = 0.1\mu F$ , $C_{OUT} = 1\mu F$	45	55		dB	
$V_{DROPP}$	Dropout Voltage <sup>(Note)</sup>	$I_{OUT} = 150mA$	$1.3V \leq V_{OUT} < 1.5V$		1.2	1.4	V
			$1.5V \leq V_{OUT} < 2.0$		1	1.2	
			$2.0V \leq V_{OUT} < 2.5$		0.7	0.8	
			$2.5V \leq V_{OUT} < 3$		0.3	0.4	
			$3V \leq V_{OUT} \leq 5$		0.2	0.3	
$I_Q$	Quiescent Current	No load		50	80	$\mu A$	
		$I_{OUT} = 150mA$		135	170		
	Shutdown Supply Current	Shutdown = low $I_{OUT} = 0$ , $V_{CC} = 6.0V$		0.01	1	$\mu A$	
	Noise	$100Hz < f < 100kHz$ , typical load, $C_{BP} = 0.1\mu F$ , $C_{OUT} = 1\mu F$		80		$\mu V_{rms}$	
		$100Hz < f < 100kHz$ , typical load, $C_{BP} = 0.33\mu F$ , $C_{OUT} = 1\mu F$		60			
	Shutdown Recovery Delay	$C_{BP} = 0.1\mu F$ , $C_{OUT} = 1\mu F$ , no load		4		ms	
		$C_{BP} = 0.33\mu F$ , $C_{OUT} = 1\mu F$ , no load		13.2			
OTS	Over Temperature Shutdown			150		$^\circ C$	
	Over Temperature Shutdown Hysteresis	Hysteresis		10		$^\circ C$	
TC	Output Voltage Temperature Coefficient			50		ppm/ $^\circ C$	
$C_{OUT}$	Output Capacitor		0.8	1.0	2.6	$\mu F$	
	ESR		0.02	0.1	1	Ohm	
	Shutdown Input Threshold	$V_{OUT} + 1.0V < V_{IN} < 6.0V$	0.4	1.6	2.5	V	
$\overline{I}_{SHDN}$	Shutdown Input Bias Current	$\overline{V}_{SHDN} = V_{IN}$		0.01	100	nA	
	Input Reverse Leakage Current	$V_{OUT} - V_{IN} = 0.1V$		0.1	0.5	$\mu A$	
	Reverse Protection Threshold			11	50	mV	

Note: Dropout voltage definition :  $V_{IN} - V_{OUT}$  when  $V_{OUT}$  is 2% below the value of  $V_{OUT}$  for  $V_{IN} = V_{OUT} + 0.5V$

## Application Circuit

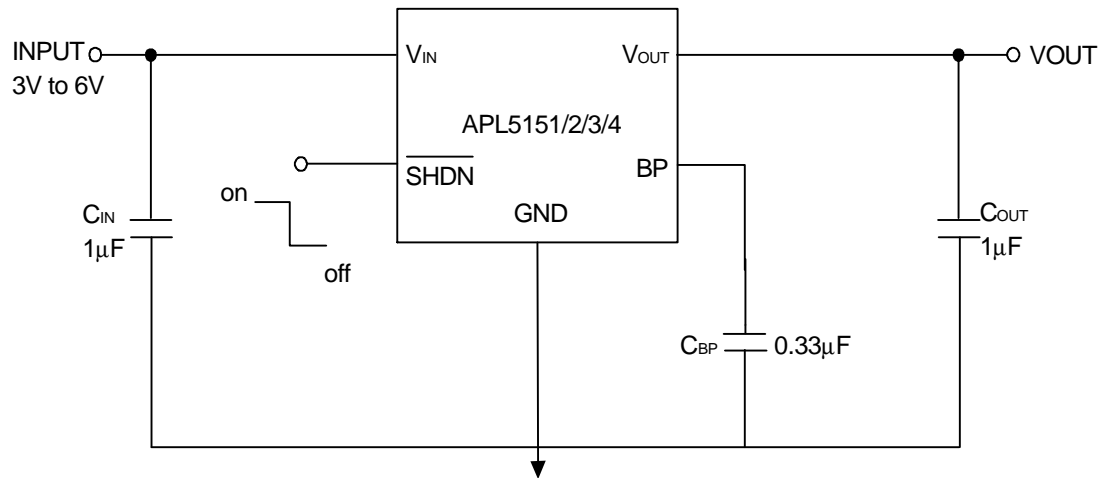

## Typical Characteristics

Current Limit vs. Input Voltage

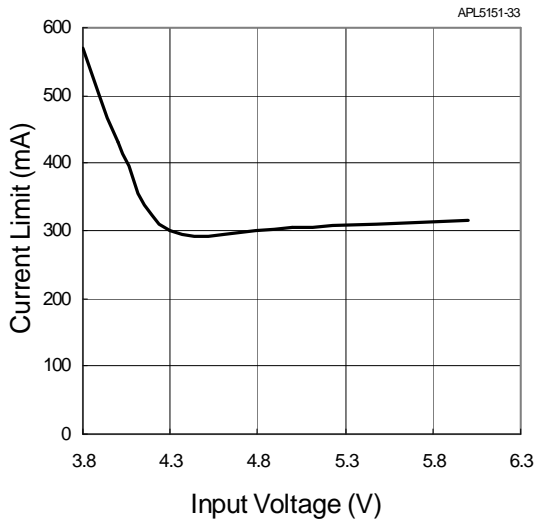

Ground Pin Current vs. Load Current

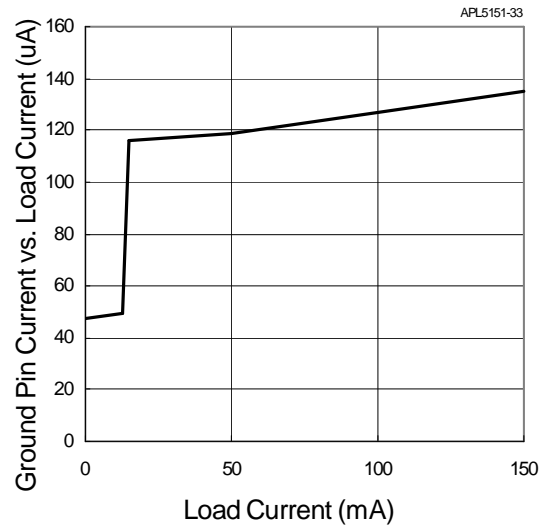

Ground Pin Current vs. Input Voltage

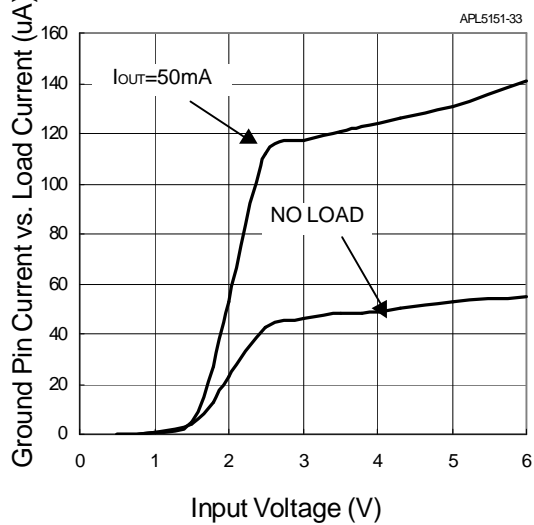

Input Voltage vs. Output Voltage

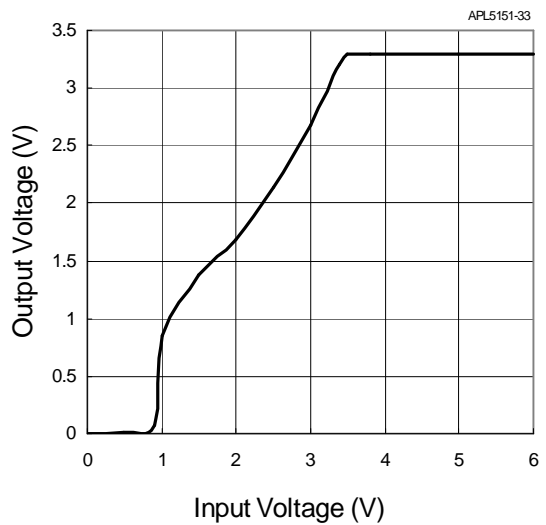

Typical Characteristics (Cont.)

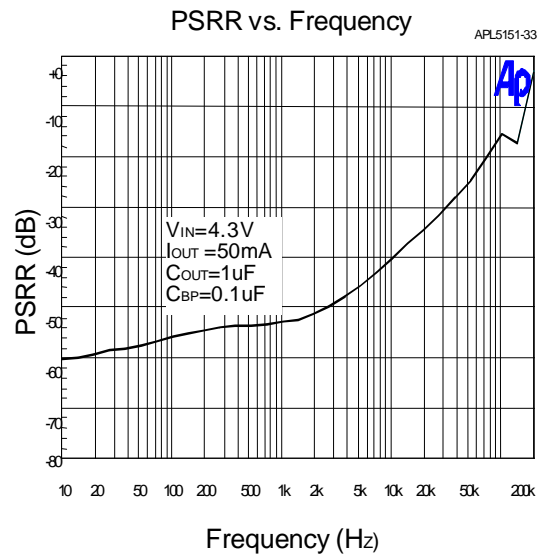
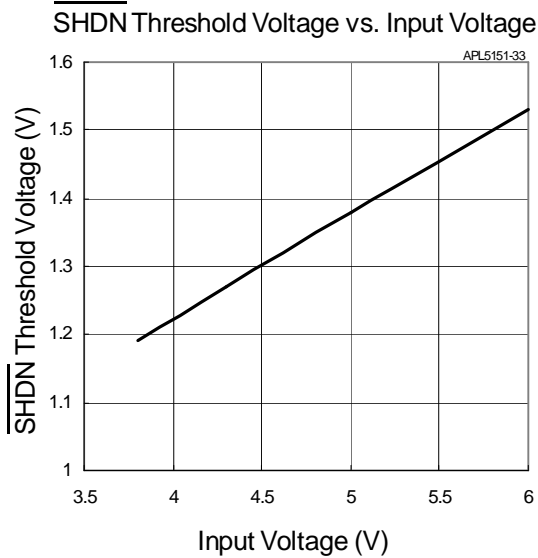
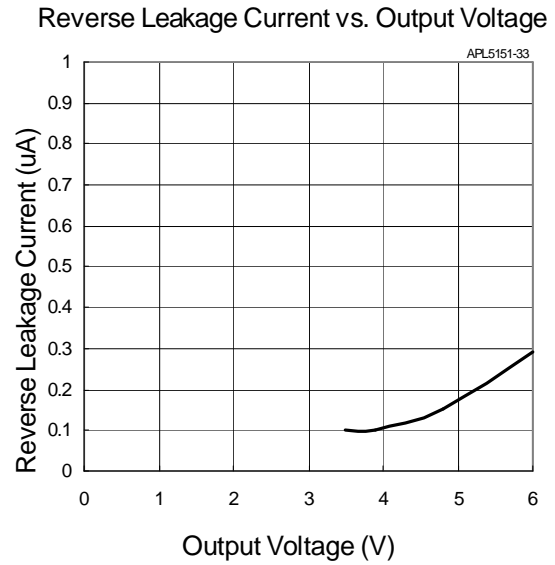
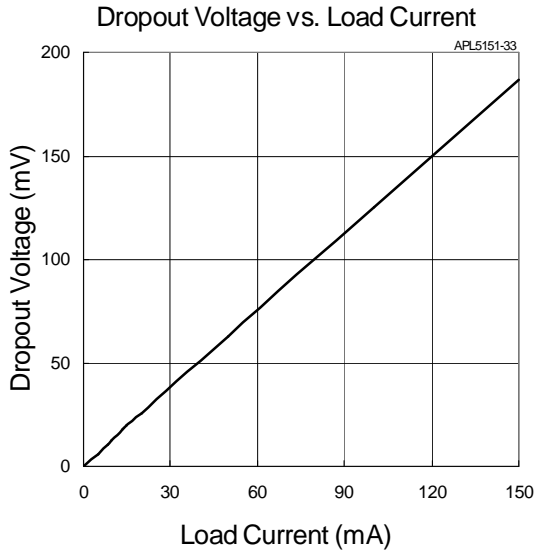

Typical Characteristics (Cont.)

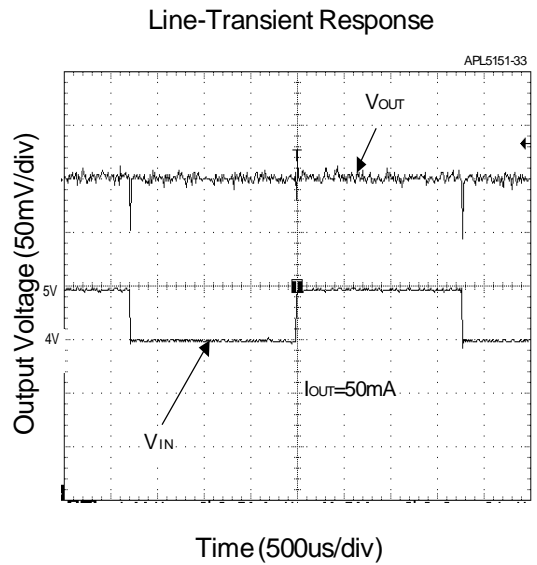
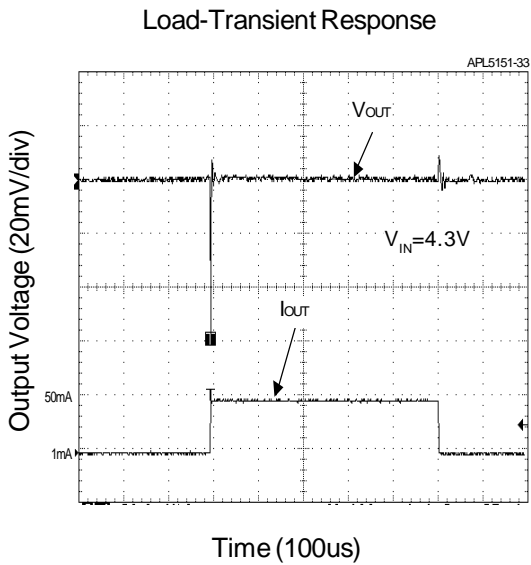
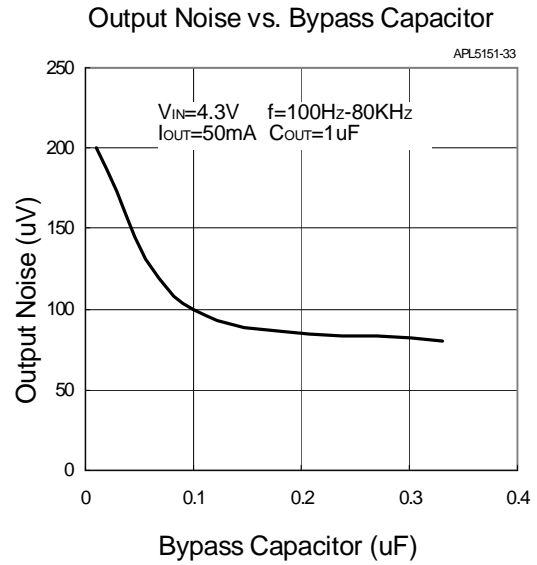
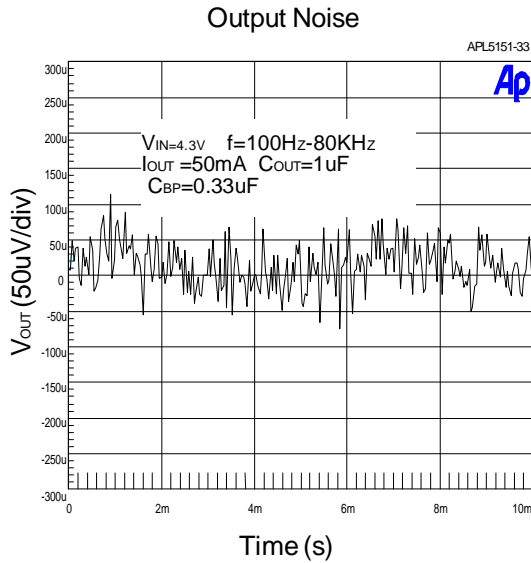



Typical Characteristics (Cont.)

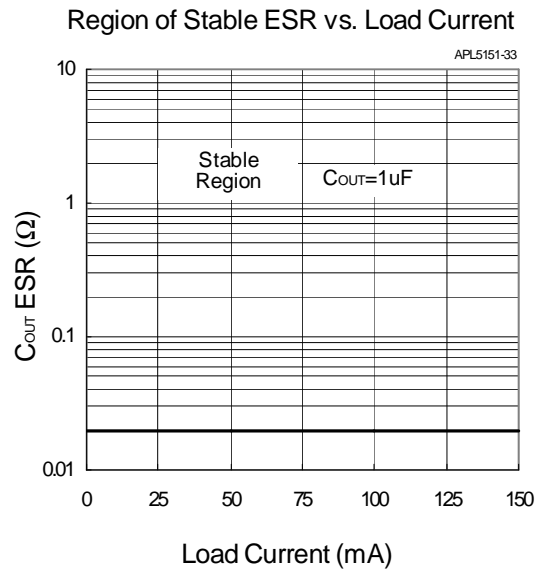
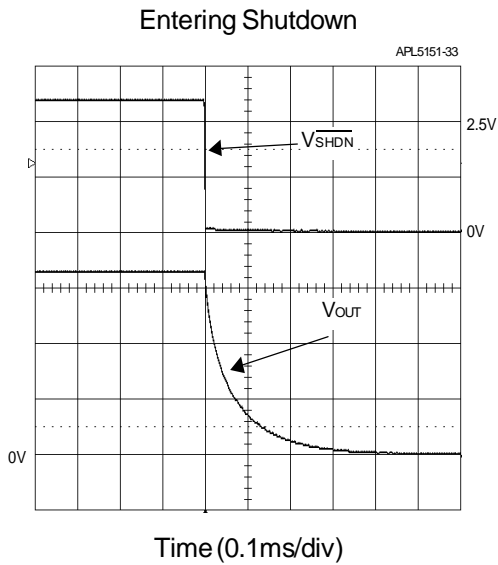
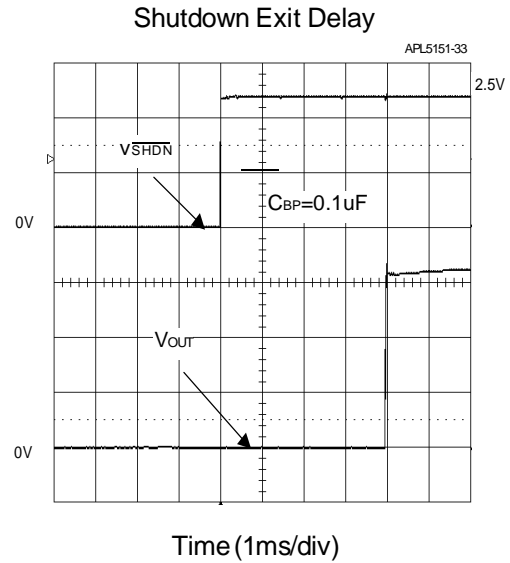
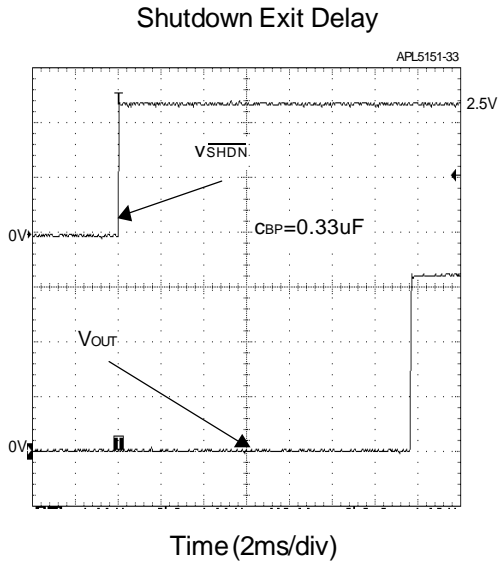

## Typical Characteristics (Cont.)

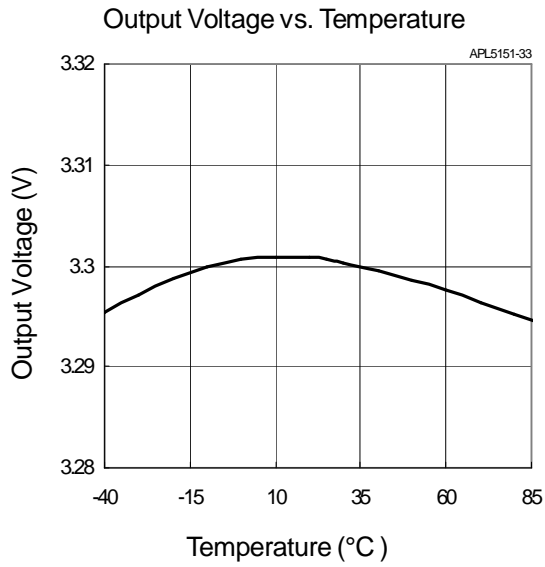

## Application Information

### Capacitor Selection and Regulator Stability

The APL5151/2/3/4 use at least a 1 $\mu$ F capacitor on the input, and this capacitor can be Aluminum, Tantalum or Ceramic capacitor. The input capacitor with larger value and lower ESR provides better PSRR and line-transient response. The output capacitor also can use Aluminum, Tantalum or Ceramic capacitor, and a minimum value of 1 $\mu$ F and ESR above 0.06 $\Omega$  is recommended. The curve of the stable region in typical characteristics shows the appropriate output capacitor ESR for different load current stable operation. A larger output capacitor can reduce noise and improve load-transient response, stability, and PSRR. Note that some ceramic dielectrics exhibit large capacitance and ESR variation with temperature. When using this capacitor, a minimum 2.2 $\mu$ F or more may be required to ensure the stability at low temperature operation. Use a bypass capacitor at BP pin for low output noise. Increasing the capacitance will slightly decrease the output noise, but increase the start-up time. (See Shutdown Exit Delay and Output Noise vs. Bypass Capacitor graph in the typical characteristics)

### Load-Transient Considerations

The APL5151/2/3/4 load-transient response graphs in typical characteristics show the transient response. A step change in the load current from 1mA to 50mA at 1 $\mu$ s will cause a 60mV transient spike. Larger output capacitor and lower ESR can reduce transient spike.

### Input-Output (Dropout)Voltage

The minimum input-output voltage difference (dropout) determines the lowest usable supply voltage. In battery-powered systems, this will determine the useful end-of-life battery voltage. Because the APL5151/2/3/4 use a p-channel MOSFET pass transistor, the dropout voltage is a function of drain-to-source on-resistance ( $R_{DS(ON)}$ ) multiplied by the load current.

### Reverse Current Protection

The APL5151/2/3/4 have an internal reverse protection, it does not need an external schottky diode to connect the regulator input and output. If the output voltage is forced above the input voltage by more than 11mV, the IC will be shutdown and the ground pin current is below 0.1 $\mu$ A.

### Current Limit

The APL5151/2/3/4 have a current limit protection. The output voltage will drop close to zero volt, when load current reaches the limit, and then the load current will be limited at 50mA after output voltage is below 0.7V. When the load current back to the value where limiting started, the output voltage and current will return to normal value. When output is shorted to ground, the APL5151/2/3/4 will keep short circuit current at 150mA .

## Thermal Protection

Thermal protection limits total power dissipation in the device. When the junction temperature exceeds  $T_J=+150$  , the thermal sensor generates a logic signal to turn off the pass transistor and allows IC to cool. When the IC's junction temperature is down by  $10$  , the thermal sensor will turn the pass transistor on again, resulting in a pulsed output during continuous thermal protection. Thermal protection is designed to protect the APL5151/2/3/4 in the event of fault conditions. For continuous operation, do not exceed the absolute maximum junction temperature of  $T_J=+150$  .

## Operating Region and Power Dissipation

The thermal resistance of the case to circuit board, and the rate of air flow all control the APL5151/2/3/4's maximum power dissipation. The power dissipation across the device is  $P_D = I_{OUT}(V_{IN}-V_{OUT})$  and the maximum power dissipation is:

$$P_{D_{MAX}} = (T_J - T_A) / (R_{JC} + R_{CA})$$

where  $T_J - T_A$  is the temperature difference between the junction and ambient air,  $R_{JC}$  is the thermal resistance of the package, and  $R_{CA}$  is the thermal resistance through the printed circuit board, copper traces, and other materials to the ambient air.

The GND pin of the APL5151/2/3/4 provide an electrical connection to ground and channeling heat away. If power dissipation is large, connect the GND pin to ground using a large pad or ground plane, can improve the problem of over heat of IC.

## Packaging Information

SOT-23-5

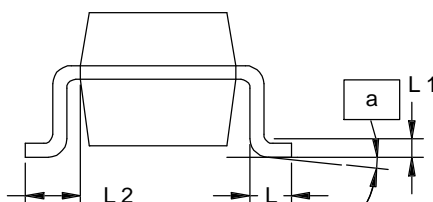
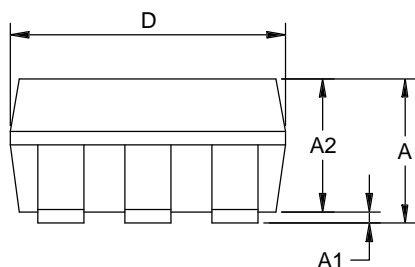
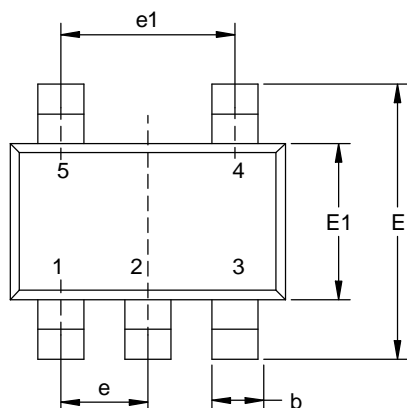

Dim	Millimeters		Inches	
	Min.	Max.	Min.	Max.
A	0.95	1.45	0.037	0.057
A1	0.05	0.15	0.002	0.006
A2	0.90	1.30	0.035	0.051
b	0.35	0.55	0.0138	0.0217
D	2.8	3.00	0.110	0.118
E	2.6	3.00	0.102	0.118
E1	1.5	1.70	0.059	0.067
e	0.95		0.037	
e1	1.90		0.075	
L	0.35	0.55	0.014	0.022
L1	0.20 BSC		0.008 BSC	
L2	0.5	0.7	0.020	0.028
N	5		5	
$\alpha$	0°	10°	0°	10°

## Physical Specifications

Terminal Material	Solder-Plated Copper (Solder Material : 90/10 or 63/37 SnPb), 100%Sn
Lead Solderability	Meets EIA Specification RSI86-91, ANSI/J-STD-002 Category 3.

### Reflow Condition (IR/Convection or VPR Reflow)

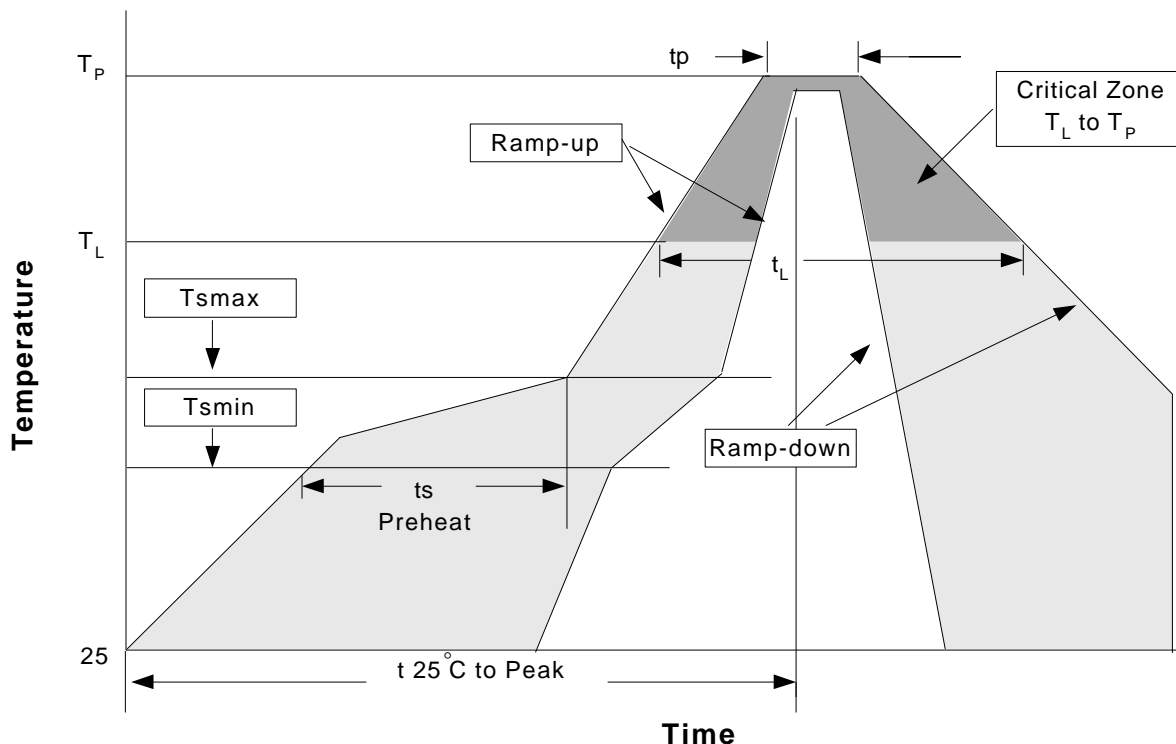

### Classification Reflow Profiles

Profile Feature	Sn-Pb Eutectic Assembly	Pb-Free Assembly
Average ramp-up rate ( $T_L$ to $T_P$ )	3°C/second max.	3°C/second max.
Preheat <ul style="list-style-type: none"> <li>- Temperature Min (<math>T_{smin}</math>)</li> <li>- Temperature Max (<math>T_{smax}</math>)</li> <li>- Time (min to max) (<math>t_s</math>)</li> </ul>	100°C 150°C 60-120 seconds	150°C 200°C 60-180 seconds
Time maintained above: <ul style="list-style-type: none"> <li>- Temperature (<math>T_L</math>)</li> <li>- Time (<math>t_L</math>)</li> </ul>	183°C 60-150 seconds	217°C 60-150 seconds
Peak/Classification Temperature ( $T_p$ )	See table 1	See table 2
Time within 5°C of actual Peak Temperature ( $t_p$ )	10-30 seconds	20-40 seconds
Ramp-down Rate	6°C/second max.	6°C/second max.
Time 25°C to Peak Temperature	6 minutes max.	8 minutes max.

Notes: All temperatures refer to topside of the package .Measured on the body surface. (mm)

## Classification Reflow Profiles(Cont.)

Table 1. SnPb Eutectic Process – Package Peak Reflow Temperatures

Package Thickness	Volume mm <sup>3</sup> <350	Volume mm <sup>3</sup> ≥350
<2.5 mm	240 +0/-5°C	225 +0/-5°C
≥2.5 mm	225 +0/-5°C	225 +0/-5°C

Table 2. Pb-free Process – Package Classification Reflow Temperatures

Package Thickness	Volume mm <sup>3</sup> <350	Volume mm <sup>3</sup> 350-2000	Volume mm <sup>3</sup> >2000
<1.6 mm	260 +0°C*	260 +0°C*	260 +0°C*
1.6 mm – 2.5 mm	260 +0°C*	250 +0°C*	245 +0°C*
≥2.5 mm	250 +0°C*	245 +0°C*	245 +0°C*

\*Tolerance: The device manufacturer/supplier **shall** assure process compatibility up to and including the stated classification temperature (this means Peak reflow temperature +0°C. For example 260°C+0°C) at the rated MSL level.

## Reliability Test Program

Test item	Method	Description
SOLDERABILITY	MIL-STD-883D-2003	245°C, 5 SEC
HOLT	MIL-STD-883D-1005.7	1000 Hrs Bias @ 125°C
PCT	JESD-22-B,A102	168 Hrs, 100%RH, 121°C
TST	MIL-STD-883D-1011.9	-65°C~150°C, 200 Cycles
ESD	MIL-STD-883D-3015.7	VHBM > 2KV, VMM > 200V
Latch-Up	JESD 78	10ms, 1 <sub>tr</sub> > 100mA

## Carrier Tape & Reel Dimensions

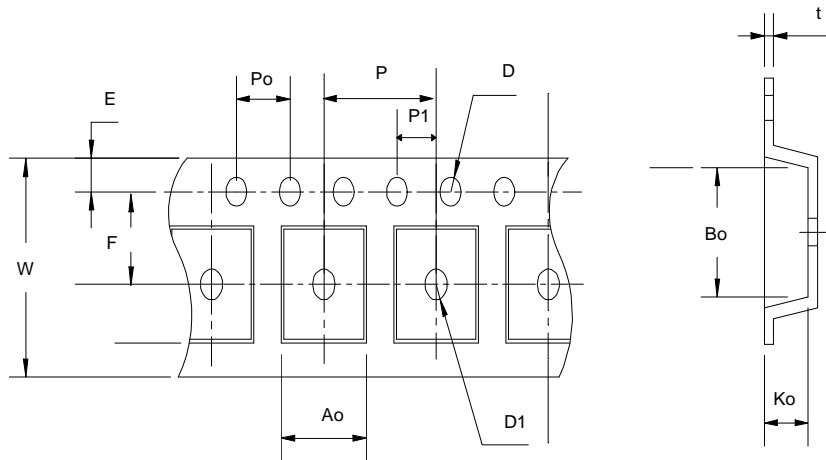

### Carrier Tape & Reel Dimensions(Cont.)

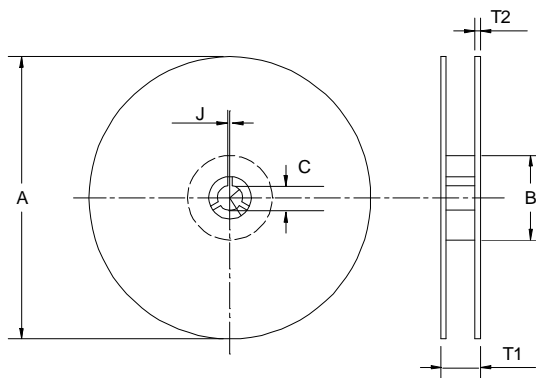

Application	A	B	C	J	T1	T2	W	P	E
SOT-23-5	178±1	72 ± 1.0	13.0 + 0.2	2.5 ± 0.15	8.4 ± 2	1.5± 0.3	8.0+ 0.3 - 0.3	4 ± 0.1	1.75± 0.1
	F	D	D1	Po	P1	Ao	Bo	Ko	t
	3.5 ± 0.05	1.5 +0.1	1.5 +0.1	4.0 ± 0.1	2.0 ± 0.1	3.15 ± 0.1	3.2± 0.1	1.4± 0.1	0.2±0.03

(mm)

### Cover Tape Dimensions

Application	Carrier Width	Cover Tape Width	Devices Per Reel
SOT- 23	8	5.3	3000

### Customer Service

**Anpec Electronics Corp.**

Head Office :

5F, No. 2 Li-Hsin Road, SBIP,

Hsin-Chu, Taiwan, R.O.C.

Tel : 886-3-5642000

Fax : 886-3-5642050

Taipei Branch :

7F, No. 137, Lane 235, Pac Chiao Rd.,

Hsin Tien City, Taipei Hsien, Taiwan, R. O. C.

Tel : 886-2-89191368

Fax : 886-2-89191369