

SG1577

Dual Synchronous DC/DC Controller

Features

- Integrated Two Sets of MOSFET Drivers
- Two Independent PWM Controllers
- Constant Frequency Operation: Free-running Fixed Frequency Oscillator Programmable: 60kHz to 320kHz
- Wide Range Input Supply Voltage: 8~15V
- Programmable Output as Low as 0.7V
- Internal Error Amplifier Reference Voltage: 0.7V±1.5%
- Two Soft-Start / EN Functions
- Programmable Over-Current Protection (OCP)
- 30V HIGH Voltage Pin for Bootstrap Voltage
- Output Over-Voltage Protection (OVP)
- SOP and DIP 20-pin

Description

The SG1577 is a high-efficiency, voltage-mode, dual-channel, synchronous DC/DC PWM controller for two independent outputs. The two channels are operated out of phase. The internal reference voltage is trimmed to 0.7V±1.5%. It is connected to the error amplifier's positive terminal for voltage feedback regulation. The soft-start circuit ensures the output voltage can be gradually and smoothly increased from zero to its final regulated value. The soft-start pin can also be used for chip-enable function. When two soft-start pins are grounded, the chip is disabled and the total operation current can be reduced to under 0.55mA. The fixed-frequency is programmable from 60kHz to 320kHz. The Over-Current Protection (OCP) level can be programmed by an external current sense resistor. It has two integrated sets of internal MOSFET drivers. SG1577 is available in 20-pin SOP and DIP packages.

Applications

- CPU and GPU Vcore Power Supply
- Power Supply Requiring Two Independent Outputs

Ordering Information

Part Number	Operating Temperature Range	Package	Packing Method
SG1577SZ	-40°C to +85°C	20-Lead, Small Outline Package (SOP-20)	Tape & Reel
SG1577SY	-40°C to +85°C	20-Lead, Small Outline Package (SOP-20)	Tape & Reel
SG1577DY	-40°C to +85°C	20-Lead, Dual In-Line Package (DIP-20)	Tube

Marking Diagram

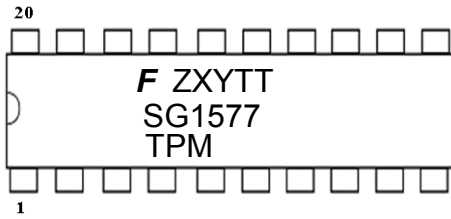

- F:** Fairchild Logo
- Z:** Plant Code
- X:** 1-Digit Year Code for SOP
2-Digit Year Code for DIP
- Y:** 1-Digit Week Code for SOP
2-Digit Week Code for DIP
- TT:** 2-Digit Die Run Code
- T:** Package Type (D = DIP,
S = SOP)
- P:** Z=Lead Free + ROHS
Compatible
Y=Green Package
- M:** Manufacture Flow Code

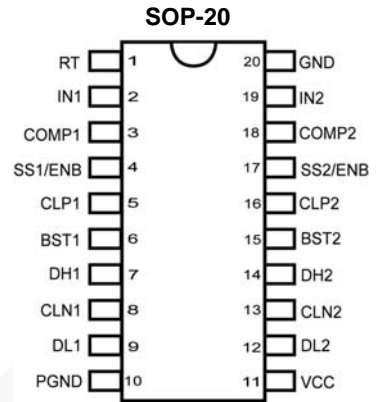

Figure 3. Top Mark

Pin Configuration

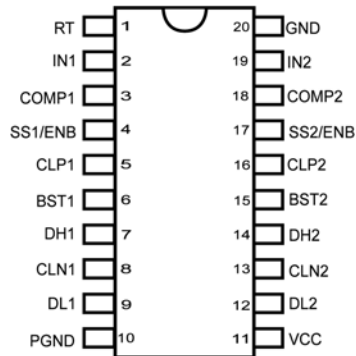

Figure 4. SOP-20 and DIP-20 Pin Configuration (Top View)

Pin Definitions

Name	Pin #	Type	Description
RT	1	Frequency Select	Switching frequency programming pin. An external resistor connecting from this pin to GND can program the switching frequency. The switching frequency would be 60kHz when RT is open and become 320kHz when a 30k Ω RT resistor is connected.
IN1	2	Feedback	Inverting input of the error amplifier. It is normally connected to the switching power supply output through a resistor divider.
COMP1	3	Compensation	Output of the error amplifier and input to the PWM comparator. It is used for feedback loop compensation.
SS1/ENB	4	Soft Start/Enable	A 10 μ A internal current source charging an external capacitor for soft start. Pull down this pin and pin 17 can disable the chip.
CLP1	5	Over Current Protection	Over-current protection for high-side MOSFET. Connect a resistor from this pin to the high-side supply voltage to program the OCP level.
BST1	6	Boost Supply	Supply for high-side driver. Connect to the internal bootstrap circuit.
DH1	7	High-Side Drive	Channel 1, high-side MOSFET gate driver pin.
CLN1	8	Switch Node	Switch-node connection to inductor. For channel 1 high-side driver's reference ground.
DL1	9	Low-Side Drive	Low-side MOSFET gate driver pin.
PGND	10	Driver Ground	Driver circuit GND supply. Connect to low-side MOSFET GND.
VCC	11	Power Supply	Supply voltage input.
DL2	12	Low-Side Drive	Low-side MOSFET gate driver pin.
CLN2	13	Switch Node	Switch-node connection to inductor. For channel 2, high-side driver's reference ground.
DH2	14	High-Side Drive	Channel 2 high-side MOSFET gate driver pin.
BST2	15	Boost Supply	Supply for high-side driver. Connect to the internal bootstrap circuit.
CLP2	16	Over-Current Protection	Over-current protection for the high-side MOSFET. Connect a resistor from this pin to the high-side supply voltage to program the OCP level.
SS2/ENB	17	Soft-Start/Enable	A 10 μ A internal current source charging an external capacitor for soft start. Pull down this pin and pin 4 can disable the chip.
COMP2	18	Compensation	Output of the error amplifier and input to the PWM comparator. It is used for feedback-loop compensation.
IN2	19	Feedback	Inverting input of the error amplifier. It is normally connected to the switching power supply output through a resistor divider.
GND	20	Control Ground	Control circuit GND supply.

Absolute Maximum Ratings

Stresses exceeding the absolute maximum ratings may damage the device. The device may not function or be operable above the recommended operating conditions and stressing the parts to these levels is not recommended. In addition, extended exposure to stresses above the recommended operating conditions may affect device reliability. The absolute maximum ratings are stress ratings only. All voltage values, except differential voltages, are given with respect to the network ground terminal. Stresses beyond those listed under "absolute maximum ratings" may cause permanent damage to the device.

Symbol	Parameter	Min.	Max.	Unit
V _{CC}	Supply Voltage, VCC to GND		16	V
BST1(or 2) - CLN1(or 2)	BST1(2) to CLN1(2)		16	V
CLN1(or 2) -GND	CLN1(2) to GND for 100ns Transient	-4	18	V
BST1(or 2) - GND	BST1(2) to GND for 100ns Transient		30	V
DH1(or 2) - CLN1(or 2)			16	V
CLN1(or 2), DL1(or 2)		-0.3	V _{CC} +0.3	V
PGND	PGND to GND		± 1	V
Θ _{JA}	Thermal Resistance, Junction-to-Air		90	°C/W
T _J	Operating Junction Temperature	-40	+125	°C
T _{STG}	Storage Temperature Range	-65	+150	°C
ESD	Human Body Model, JESD22-A114		2.5	kV
	Charged Device Model, JESD22-C101		750	V

Recommended Operating Conditions

The Recommended Operating Conditions table defines the conditions for actual device operation. Recommended operating conditions are specified to ensure optimal performance to the datasheet specifications. Fairchild does not recommend exceeding them or designing to absolute maximum ratings.

Symbol	Parameter	Min.	Max.	Unit
V _{CC}	Supply Voltage	+8	+15	V
T _A	Operating Ambient Temperature	-40	+85	°C

Electrical Characteristics

$V_{CC}=12V$, $T_A=25^{\circ}C$, unless otherwise noted.

Symbol	Parameter	Conditions	Min.	Typ.	Max.	Unit
Oscillator						
f_{osc}	Oscillator Frequency	$R_{RT}=OPEN$	54	60	66	KHz
		$R_{RT}=GND$	288	320	352	
$f_{osc,rt}$	Total Accuracy	$20k\Omega < R_{RT}$	-10		10	%
D_{ON_MAX}	Maximum Duty Cycle		85	90	95	%
Error Amplifier						
V_{REF}	Internal Reference Voltage	$V_{CC}=8V, V_{CC}=15V$	0.6895	0.7000	0.7105	V
ΔV_{REF}	Temperature Coefficient ⁽¹⁾	$T_A=0\sim 85^{\circ}C$		0.03		mV/°C
A_{VOL}	Open-Loop Voltage Gain			77		dB
BW	Unity Gain Bandwidth			3.5		MHz
PSRR	Power Supply Rejection Ratio			50		dB
I_{SOURCE}	Output Source Current	$I_{N1}=I_{N2}=0.6V$	60	80	100	μA
I_{SINK}	Output Sink Current	$I_{N1}=I_{N2}=0.8V$		500		μA
V_{H_COMP}	Output Voltage	$I_{N1}=I_{N2}=0.6V$		5		V
V_{L_COMP}	Output Voltage	$I_{N1}=I_{N2}=0.8V$		100		mV
Soft Start						
I_{SOURCE}	Soft-Start Charge Current	$V_{CLP} < V_{CLN}$	8	10	12	μA
I_{SINK}	Soft-Start Discharge Current	$V_{CLP} > V_{CLN}$	0.8	1.0	1.2	μA
Protections						
I_{OSCT}	OC Sink Current	$V_{CC}=12V$	90	120	150	μA
T_{OT}	Over-Temperature			150		°C
T_{OT_hys}	Over-Temperature Hysteresis			20		°C
V_{OVP}	Over-Voltage Protection of IN	V_{OVP}/V_{IN}	112		125	%
Output						
I_{DH}	High-Side Current Source	$V_{BST} - V_{CLN}=12V, V_{DH} - V_{CLN}=6V$	1.0	1.7		A
R_{DH}	High-Side Sink Resistor	$V_{BST} - V_{CLN}=12V$		3.3	4.0	Ω
I_{DL}	Low-Side Current Source	$V_{CC}=12V, V_{DL}=6V$	1.0	1.7		A
R_{DL}	Low-Side Sink Resistor	$V_{CC}=12V$		3.1	4.0	Ω
t_{DT}	Dead Time ⁽²⁾	$V_{CC}=12V, D_H$ and $D_L=1000pF$	10	40	70	ns
Total Operating Current						
I_{CC_OP}	Operating Supply Current	$V_{CC}=12V$, No Load	3.3	4.3	5.3	mA
I_{CC_SBY}	Standby Current (Disabled)	$SS1/ENB=SS2/ENB=0V$		0.55	1.00	mA

Notes:

- Not tested in production; 30pcs sample.
- When V_{DL} falls less than 2V relative to V_{DH} rising to 2V.

Typical Performance Characteristics

Unless otherwise noted, values are for $V_{CC}=12V$, $T_A=+25^{\circ}C$, and according to Figure 1.

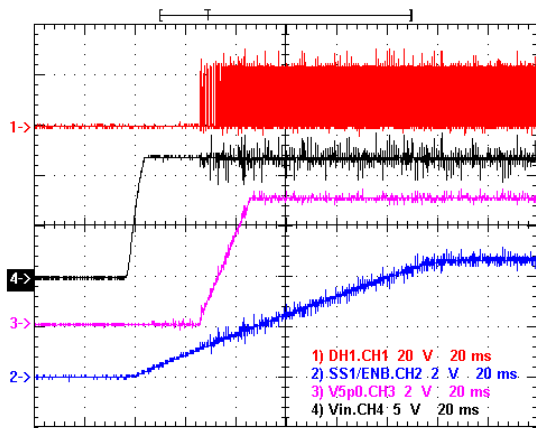

Figure 5. V5p0 Power On with 1.6A Load

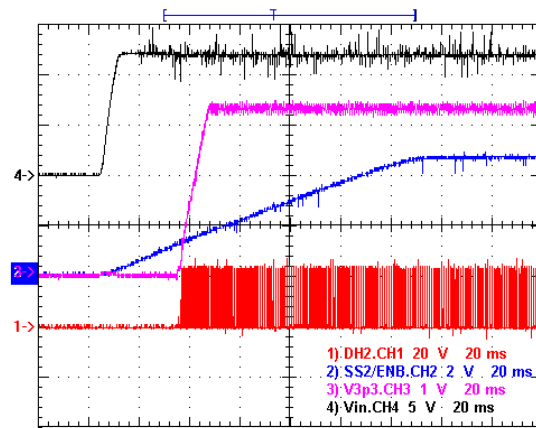

Figure 6. V3p3 Power On with 3A Load

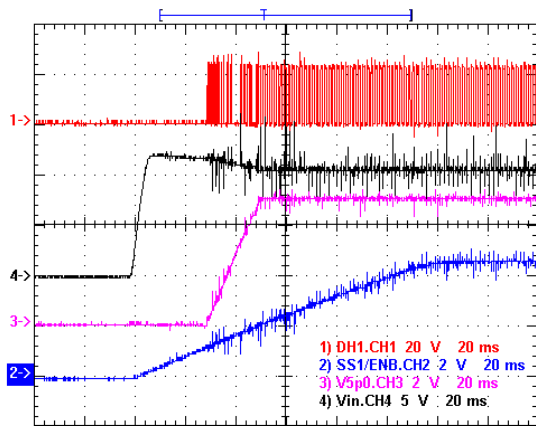

Figure 7. V5p0 Power On with 15A Load

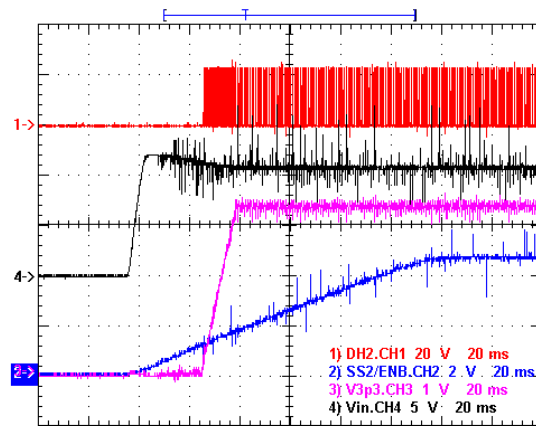

Figure 8. V3p3 Power On with 8A Load

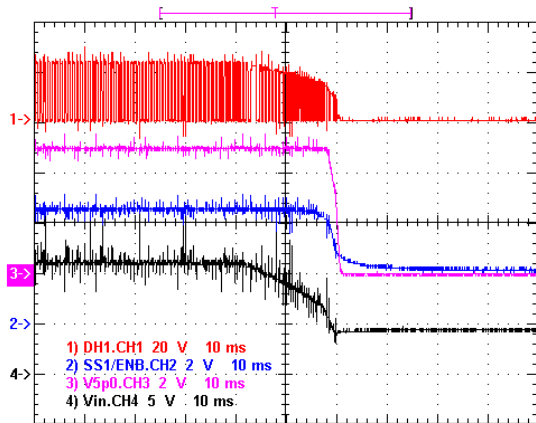

Figure 9. V5p0 Power Off with 15A Load

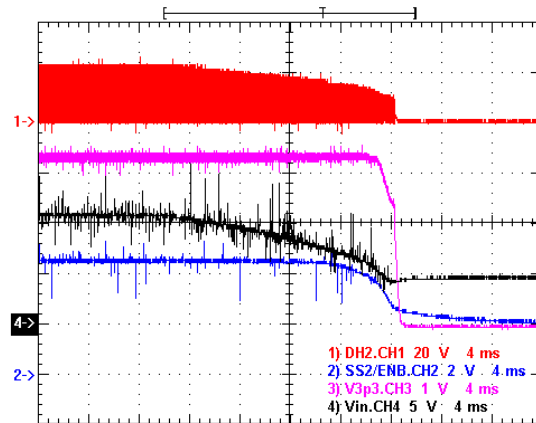

Figure 10. V3p3 Power Off with 8A Load

Typical Performance Characteristics (Continued)

Unless otherwise noted, values are for $V_{CC}=12V$, $T_A=+25^{\circ}C$, and according to Figure 1.

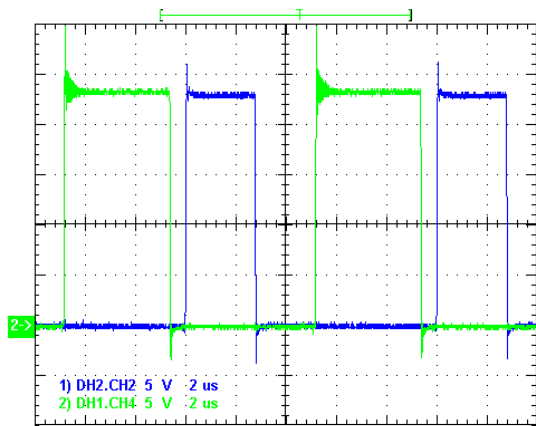

Figure 11. 3p3 and V5p0 Phase Shift with Light Load

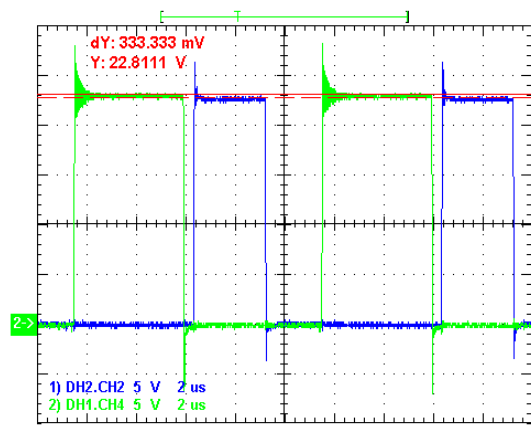

Figure 12. V3p3 and V5p0 Phase Shift with Heavy Load

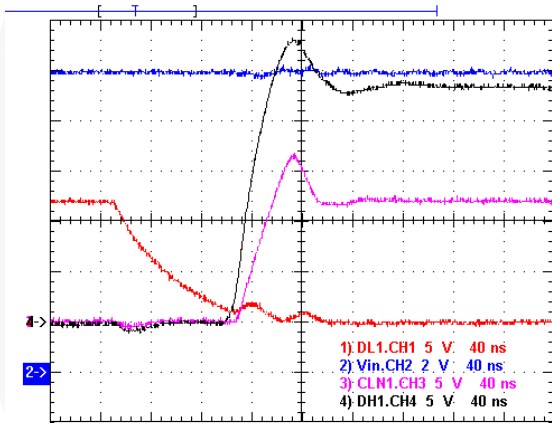

Figure 13. Dead Time with Light Load (Rise Edge)

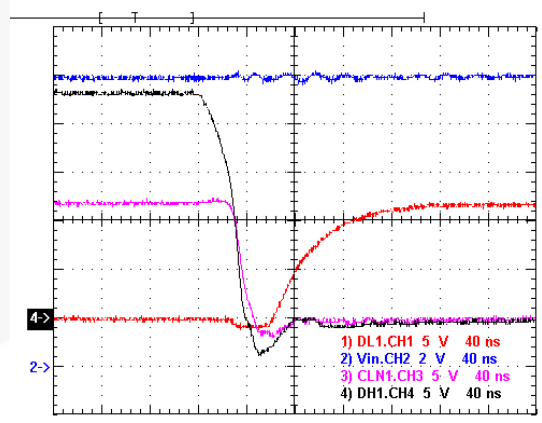

Figure 14. Dead Time with Light Load (Fall Edge)

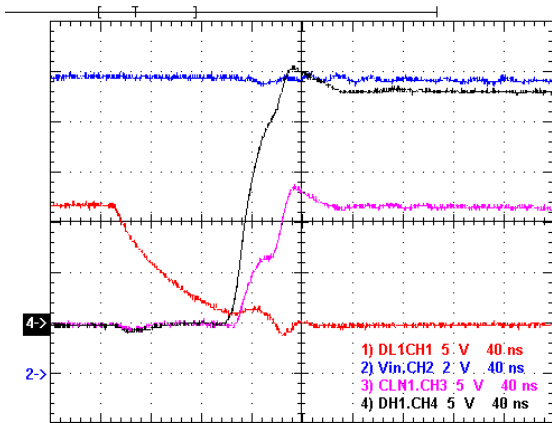

Figure 15. Dead Time with Heavy Load (Rise Edge)

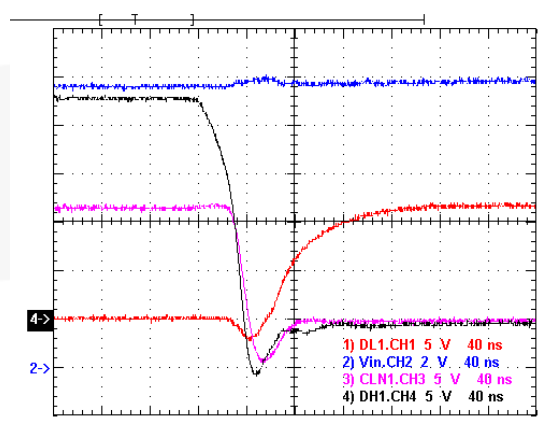

Figure 16. Dead Time with Heavy Load (Fall Edge)

Typical Performance Characteristics (Continued)

Unless otherwise noted, values are for $V_{CC}=12V$, $T_A=+25^{\circ}C$, and according to Figure 1.

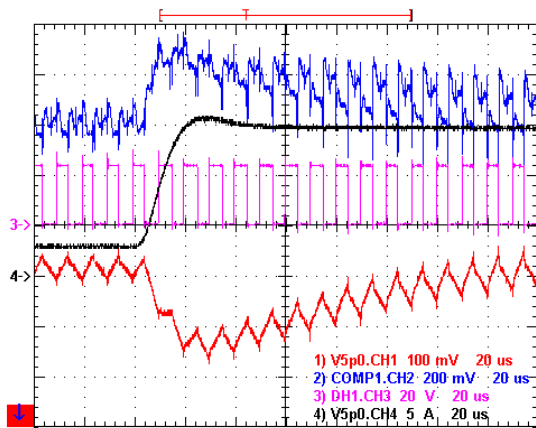

Figure 17. Load Transient Response (Step-Up)
20k Ω /22nF in Compensation Loop

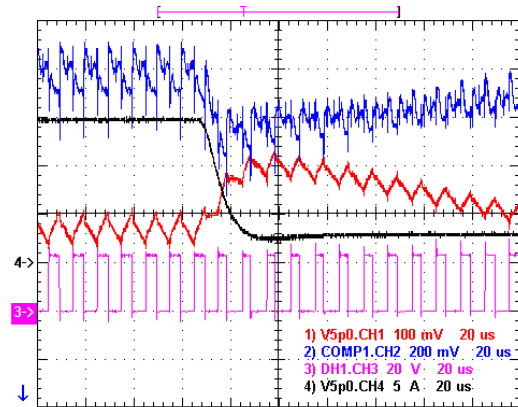

Figure 18. Load Transient Response (Step-Down)
20k Ω /22nF in Compensation Loop

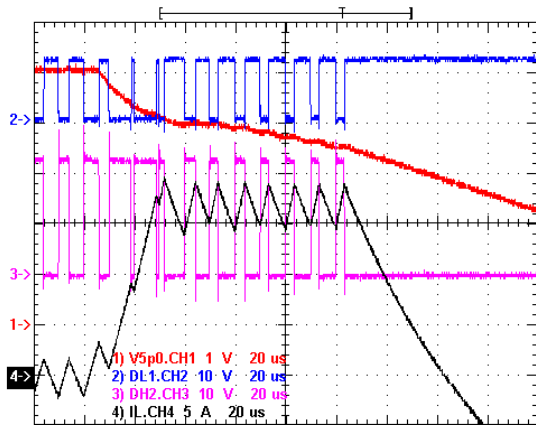

Figure 19. Over-Current Protection (OCP)

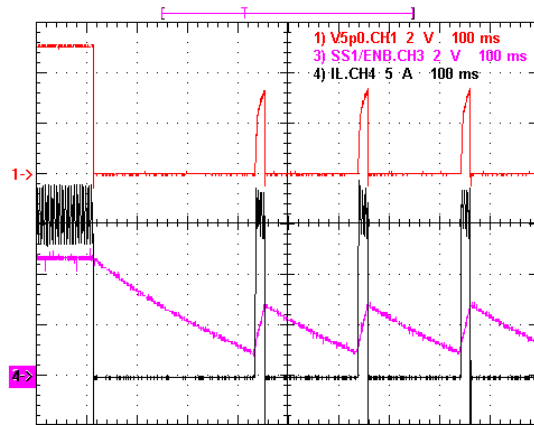

Figure 20. Over-Current Protection (Hiccup Mode)

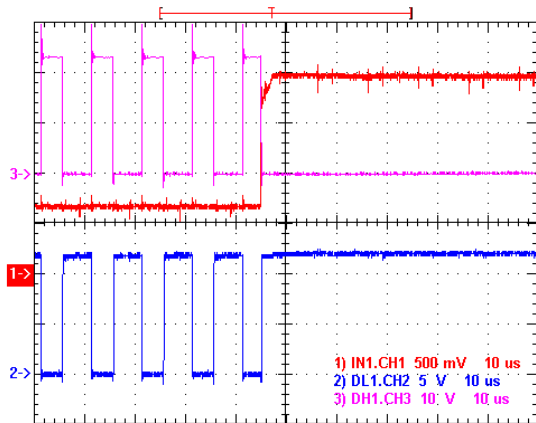

Figure 21. Over-Voltage Protection (OVP)

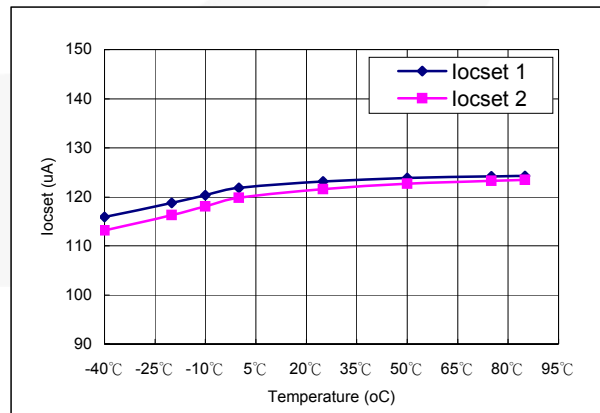

Figure 22. Iocset vs. Temperature

Functional Description

The SG1577 is a dual-channel voltage-mode PWM controller. It has two sets of synchronous MOSFET driving circuits. The two channels are running 180-degrees out of phase. The following descriptions highlight the advantages of the SG1577 design.

Soft-Start

An internal startup current (10 μ A) flows out of SS/ENB pin to charge an external capacitor. During the startup sequence, SG1577 isn't enabled until the SS/ENB pin is higher than 1.2V. From 1.2V to $(1.2 + 1.6 \times D_{ON} / D_{ON_MAX})$ V, PWM duty cycle gradually increases following SS/ENB pin voltage to bring output rising. After $(1.2 + 1.6 \times D_{ON} / D_{ON_MAX})$ V, the soft-start period ends and SS/ENB pin continually goes up to 4.8V. When input power is abnormal, the external capacitor on SS pin is shorted to ground and the chip is disabled.

$$t_{SOFTSTART} = C_{SS/ENB} \times 1.6 \times D_{ON} / D_{ON_MAX} / I_{SOURCE} \quad (1)$$

Over-Current Protection (OCP)

Over-current protection is implemented by sensing the voltage drop across the drain and the source of external high-side MOSFET. Over-current protection is triggered when the voltage drop on external high-side MOSFET's $R_{DS(ON)}$ is greater than the programmable current limit voltage threshold. 120 μ A flowing through an external resistor between input voltage and the CLP pin sets the threshold of current limit voltage. When over-current condition is true, the system is protected against the cycle-by-cycle current limit. A counter counts a series of over-current peak values to eight cycles; the soft-start capacitor is discharged by a 1 μ A current until the voltage on SS pin reaches 1.2V. During the discharge period, the high-side driver is turned off and the low-side driver is turned on. Once the voltage on SS/ENB pin is under 1.2V, the normal soft-start sequence is initiated and the 10 μ A current charges the soft-start capacitor again.

$$I_{L(OCP)} = [(R_{SENSE} \times I_{OCSET} + V_{OFFSET}) / R_{DS(ON)} - (V_{IN} - V_{OUT}) \times V_{OUT} / (f_{OSC} \times L_{OUT} \times V_{IN} \times 2)] \quad (2)$$

where V_{OFFSET} (≈ 10 mV) is the offset voltage contributed by the internal OCP comparator.

Design Notes

V_{CC} noise/spike affects the offset voltage of the OCP comparator. Figure 23 shows the $V_{OFFSET1/2}$ vs. V_{CC} variation curve, which is a simulation result by IC internal circuitry. Calculate the OCP variation between $V_{CC}=12$ V and $V_{CC}=4$ V. For Ch1 or Ch2, $V_{OFFSET} / R_{DS(ON)} = 172$ mV / 9 m $\Omega = 19$ A is affected. $V_{CC}>10$ V is the recommended range; lower, and the comparator's offset voltage is large.

Prevent CLN noise in SG1577

To prevent noise/spike on CLN from affecting OCP judgment, SG1577 internal has a 500ns blanking time to filter out this noise/spike on CLN at each turn-on cycle and counts for eight cycles of $CLP > CLN$, then OCP is asserted.

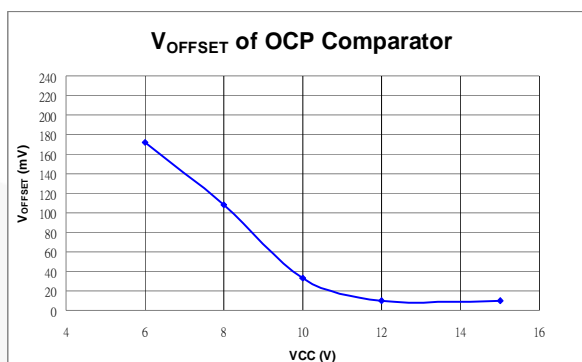

Figure 23. $V_{OFFSET1/2}$ vs. V_{CC}

Error Amplifier

The IN1 and IN2 pins are connected to the corresponding internal error amplifier's inverting input and the outputs of the error amplifiers are connected to the corresponding COMP1 and COMP2 pins. The COMP1 and COMP2 pins are available for control-loop compensation externally. Non-inverting inputs are internally tied to a fixed $0.7V \pm 1.5\%$ reference voltage.

Oscillator Operation

The SG1577 has a frequency-programmable oscillator. The oscillator is running at 60kHz when the RT pin is floating. The oscillator frequency can be adjusted from 60kHz up to 320kHz by an external resistor R_{RT} between RT pin and the ground. The oscillator generates a sawtooth wave that has 90% rising duty. Sawtooth wave voltage threshold is from 1.2V to 2.8V. The frequency of oscillator can be programmed by the following equation:

$$f_{OSC, RT(kHz)} = 60kHz + 8522 / R_{RT}(k\Omega) \quad (3)$$

Output Driver

The high-side gate drivers need an external bootstrapping circuit to provide the required boost voltage. The highest gate driver's output (15V is the allowed) on high-side and low-side MOSFETs forces external MOSFETs to have the lowest $R_{DS(ON)}$, which results in higher efficiency.

Over-Temperature Protection (OTP)

The device is over-temperature protected. When chip temperature is over 150 C, the chip enters tri-state (high-side driver is turned off). The hysteresis is 20 C.

Type II Compensation Design (for Output Capacitors with High ESR)

SG1577 is a voltage-mode controller; the control loop is a single voltage feedback path, including an error amplifier and PWM comparator, as shown in Figure 24. To achieve fast transient response and accurate output regulation, an adequate compensator design is necessary. A stable control loop has a 0dB gain crossing with -20dB/decade slope and a phase margin greater than 45°.

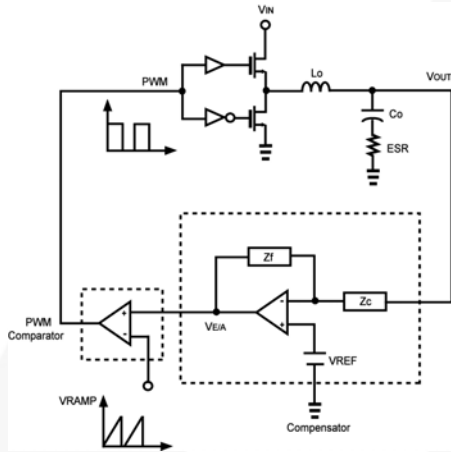

Figure 24. Closed Loop

1. Modulator Frequency Equations

The modulator transfer function is the small-signal transfer function of $V_{OUT}/V_{E/A}$. This transfer function is dominated by a DC gain and the output filter (L_O and C_O) with a double-pole frequency at f_{LC} and a zero at f_{ESR} . The DC gain of the modulator is the input voltage (V_{IN}) divided by the peak-to-peak oscillator voltage $V_{RAMP}(=1.6V)$. The first step is to calculate the complex conjugate poles contributed by the LC output filter. The output LC filter introduces a double-pole, -40dB / decade gain slope above its corner resonant frequency and a total phase lag of 180°. The resonant frequency of the LC filter expressed as:

$$f_{P(LC)} = \frac{1}{2\pi \times \sqrt{L_O \times C_O}} \quad (4)$$

The next step of compensation design is to calculate the ESR zero. The ESR zero is contributed by the ESR associated with the output capacitance. Note that this requires that the output capacitor should have enough ESR to satisfy stability requirements. The ESR zero of the output capacitor is expressed as:

$$f_{Z(ESR)} = \frac{1}{2\pi \times C_O \times ESR} \quad (5)$$

2. Compensation Frequency Equations

The compensation network consists of the error amplifier and the impedance networks Z_C and Z_f , as Figure 25 shows.

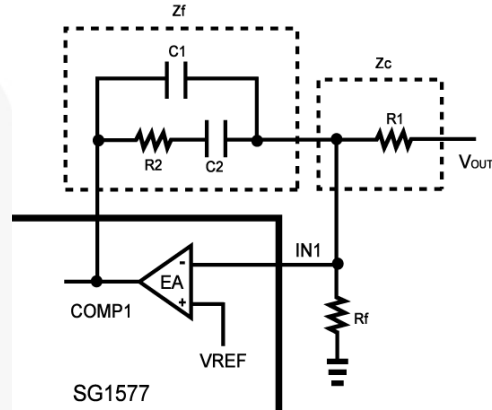

Figure 25. Compensation Loop

$$\begin{aligned} f_{P1} &= 0 \\ f_{Z1} &= \frac{1}{2\pi \times R_2 \times C_2} \\ f_{P2} &= \frac{1}{2\pi \times R_2 \times (C_1 // C_2)} \end{aligned} \quad (6)$$

Figure 26 shows the DC-DC converter gain vs. frequency. The compensation gain uses external impedance networks Z_C and Z_f to provide a stable, high-bandwidth loop.

High crossover frequency is desirable for fast transient response, but often jeopardizes the system stability. To cancel one of the LC filter poles, place the zero before the LC filter resonant frequency. Place the zero at 75% of the LC filter resonant frequency. Crossover frequency should be higher than the ESR zero, but less than 1/5 of the switching frequency. The second pole should be placed at half the switching frequency.

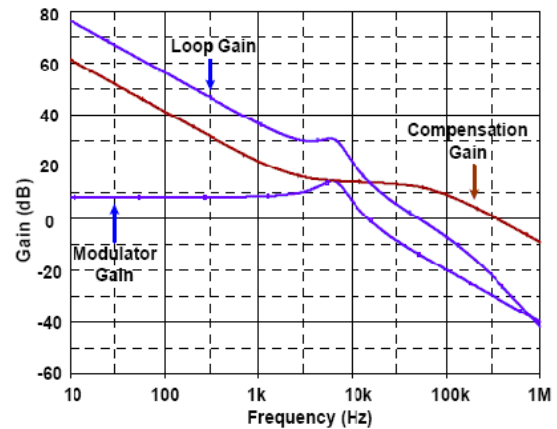

Figure 26. Bode Plot

Layout Considerations

Layout is important in high-frequency switching converter design. If designed improperly, PCB can radiate excessive noise and contribute to converter instability.

Place the PWM power stage components first. Mount all the power components and connections in the top layer with wide copper areas. The MOSFETs of buck, inductor, and output capacitor should be as close to each other as possible to reduce the radiation of EMI due to the high-frequency current loop. If the output capacitors are placed in parallel to reduce the ESR of capacitor, equal sharing ripple current should be considered. Place the input capacitor near the drain of high-side MOSFET. In multi-layer PCB, use one layer as power ground and have a separate control signal ground as the reference for all signals. To avoid the signal ground being affected by noise and have best load regulation, it should be connected to the ground terminal of output.

Follow the below guidelines for best performance:

- 1 A two-layer printed circuit board is recommended.
- 2 Use the bottom layer of the PCB as a ground plane and make all critical component ground connections through vias to this layer.
- 3 Keep the metal running from the CLNx terminal to the output inductor short.
- 4 Use copper-filled polygons on the top (and bottom, if two-layer PCB) circuit layers for the CLN node.
- 5 The small-signal wiring traces from the DLx and DHx pins to the MOSFET gates should be kept short and wide enough to easily handle the several amps of drive current.
- 6 The critical, small-signal components include any bypass capacitors (SMD-type of capacitors applied at VCC and SSx/ENB pins), feedback components (resistor divider), and compensation components (between INx and COMPx pins). Position those components close to their pins with a local, clear GND connection or directly to the ground plane.
- 7 Place the bootstrap capacitor near the BSTx and CLNx pins.
- 8 The resistor on the RT pin should be near this pin and the GND return should be short and kept away from the noisy MOSFET's GND (which is short together with IC's PGND pin to GND plane on back side of PCB).
- 9 Place the compensation components close to the INx and COMPx pins.
- 10 Located feedback resistors for both regulators should be as close as possible to the relevant INx pin with vias tied straight to the ground plane as required.
- 11 Minimize the length of the connections between the input capacitors, CIN, and the power switchers (MOSFETs) by placing them nearby.
- 12 Position both the ceramic and bulk input capacitors as close to the upper MOSFET drain as possible and make the GND returns (from the source of lower MOSFET to V_{IN} capacitor GND) short.
- 13 Position the output inductor and output capacitors between the upper MOSFET and lower MOSFET and the load.
- 14 AGND should be on the clearer plane and kept away from the noisy MOSFET GND.
- 15 PGND should be short, together with MOSFET GND, then through vias to GND plane on the bottom of PCB.
- 16 Prevent a spike on the CLN pin with a proper snubber circuit for CLN and GND.

Physical Dimensions

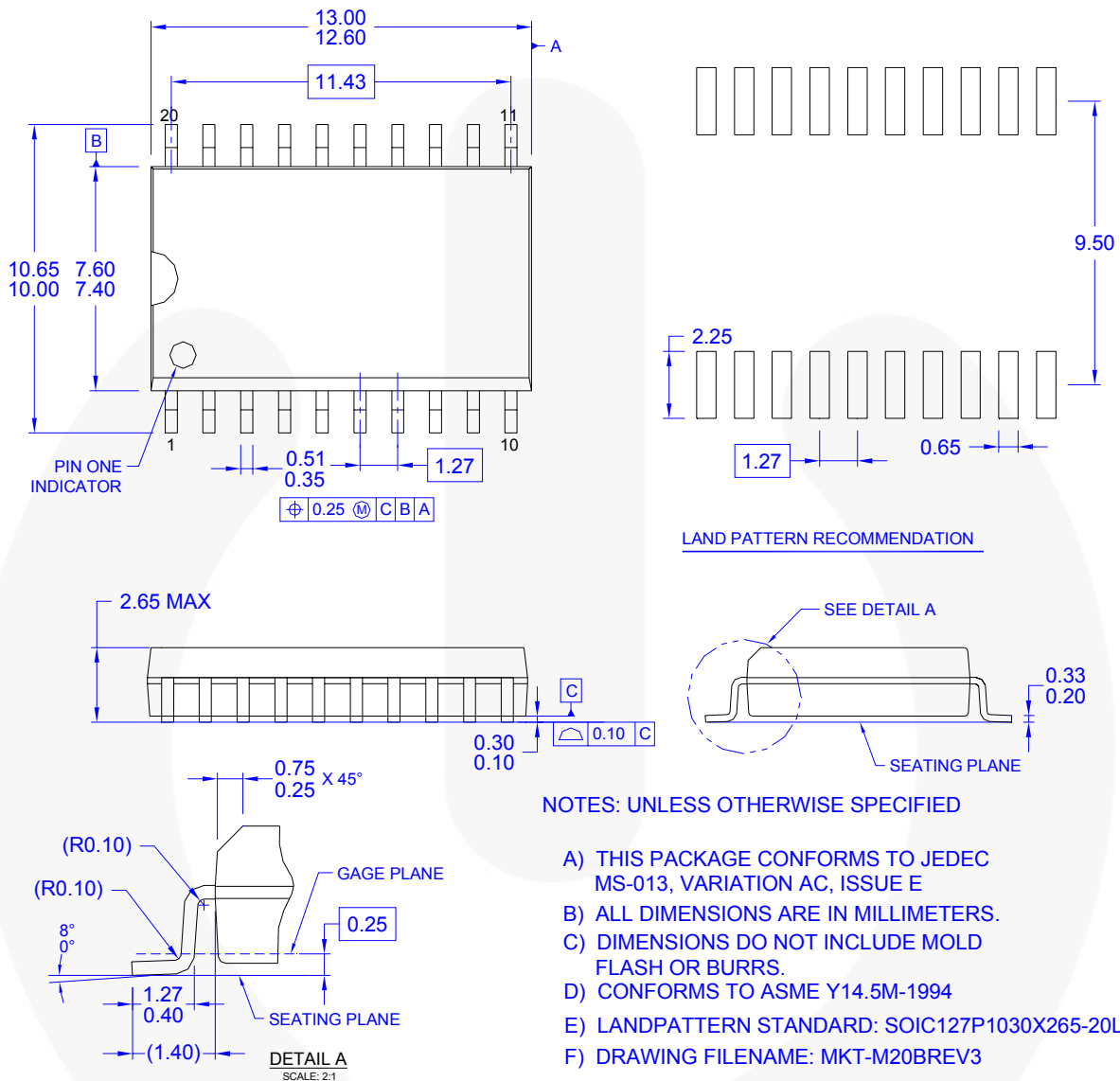
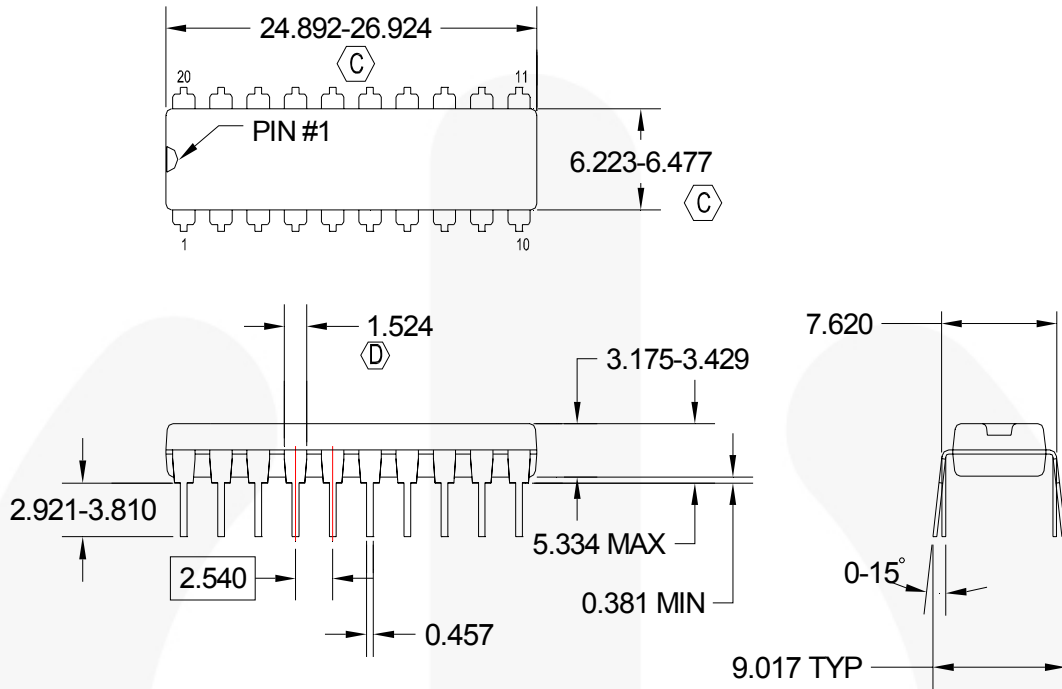

Figure 27. 20-Lead Small Outline Package (SOP)

Package drawings are provided as a service to customers considering Fairchild components. Drawings may change in any manner without notice. Please note the revision and/or date on the drawing and contact a Fairchild Semiconductor representative to verify or obtain the most recent revision. Package specifications do not expand the terms of Fairchild's worldwide terms and conditions, specifically the warranty therein, which covers Fairchild products.

Always visit Fairchild Semiconductor's online packaging area for the most recent package drawings:
<http://www.fairchildsemi.com/packaging/>

Physical Dimensions (Continued)



NOTES:

- A. CONFORMS TO JEDEC REGISTRATION MS-001, VARIATIONS AD
- B. ALL DIMENSIONS ARE IN MILLIMETERS
- C. DOES NOT INCLUDE MOLD FLASH OR PROTRUSIONS. MOLD FLASH OR PROTRUSIONS SHALL NOT EXCEED 0.25MM.
- D. DOES NOT INCLUDE DAMBAR PROTRUSIONS. DAMBAR PROTRUSIONS SHALL NOT EXCEED 0.25MM.
- E. DRAWING FILE NAME: N20SREV1

Figure 28. 20-Lead Small Outline Package (DIP)

Package drawings are provided as a service to customers considering Fairchild components. Drawings may change in any manner without notice. Please note the revision and/or date on the drawing and contact a Fairchild Semiconductor representative to verify or obtain the most recent revision. Package specifications do not expand the terms of Fairchild's worldwide terms and conditions, specifically the warranty therein, which covers Fairchild products.

Always visit Fairchild Semiconductor's online packaging area for the most recent package drawings:
<http://www.fairchildsemi.com/packaging/>



TRADEMARKS

The following includes registered and unregistered trademarks and service marks, owned by Fairchild Semiconductor and/or its global subsidiaries, and is not intended to be an exhaustive list of all such trademarks.

- | | | | |
|--------------------------|------------------------|---------------------------------------|--|
| AccuPower™ | F-PFS™ | Power-SPM™ | <p>SYSTEM GENERAL
The Power Franchise®
the Power franchise
TinyBoost™
TinyBuck™
TinyCalc™
TinyLogic™
TINYOPTO™
TinyPower™
TinyPWM™
TinyWire™
TriFault Detect™
TRUECURRENT™*
µSerDes™
 SerDes
UHC™
Ultra FRFET™
UniFET™
VCX™
VisualMax™
XS™</p> |
| Auto-SPM™ | FRFET® | PowerTrench® | |
| Build it Now™ | Global Power Resource™ | PowerXS™ | |
| CorePLUS™ | Green FPS™ | Programmable Active Droop™ | |
| CorePOWER™ | Green FPS™ e-Series™ | QFET® | |
| CROSSVOL7™ | Gmax™ | QST™ | |
| CTL™ | GTO™ | Quiet Series™ | |
| Current Transfer Logic™ | IntelliMAX™ | RapidConfigure™ | |
| DEUXPEED® | ISOPLANAR™ | ™ | |
| Dual Cool™ | MegaBuck™ | Saving our world, 1mW/W/kW at a time™ | |
| EcoSPARK® | MICROCOUPLER™ | SignalWise™ | |
| EfficientMax™ | MicroFET™ | SmartMax™ | |
| ESBC™ | MicroPak™ | SMART START™ | |
| Fairchild® | MicroPak2™ | SPM® | |
| Fairchild Semiconductor® | MillerDrive™ | STEALTH™ | |
| FACT Quiet Series™ | MotionMax™ | SuperFET™ | |
| FACT® | Motion-SPM™ | SuperSOT™.3 | |
| FAST® | OptoHIT™ | SuperSOT™.6 | |
| FAST® | OPTOLOGIC® | SuperSOT™.8 | |
| FastvCore™ | OPTOPLANAR® | SupreMOS® | |
| FETBench™ | ™ | SyncFET™ | |
| FlashWriter®* | PDP SPM™ | Sync-Lock™ | |
| FP5™ | | | |

* Trademarks of System General Corporation, used under license by Fairchild Semiconductor.

DISCLAIMER

FAIRCHILD SEMICONDUCTOR RESERVES THE RIGHT TO MAKE CHANGES WITHOUT FURTHER NOTICE TO ANY PRODUCTS HEREIN TO IMPROVE RELIABILITY, FUNCTION, OR DESIGN. FAIRCHILD DOES NOT ASSUME ANY LIABILITY ARISING OUT OF THE APPLICATION OR USE OF ANY PRODUCT OR CIRCUIT DESCRIBED HEREIN; NEITHER DOES IT CONVEY ANY LICENSE UNDER ITS PATENT RIGHTS, NOR THE RIGHTS OF OTHERS. THESE SPECIFICATIONS DO NOT EXPAND THE TERMS OF FAIRCHILD'S WORLDWIDE TERMS AND CONDITIONS, SPECIFICALLY THE WARRANTY THEREIN, WHICH COVERS THESE PRODUCTS.

LIFE SUPPORT POLICY

FAIRCHILD'S PRODUCTS ARE NOT AUTHORIZED FOR USE AS CRITICAL COMPONENTS IN LIFE SUPPORT DEVICES OR SYSTEMS WITHOUT THE EXPRESS WRITTEN APPROVAL OF FAIRCHILD SEMICONDUCTOR CORPORATION.

As used herein:

1. Life support devices or systems are devices or systems which, (a) are intended for surgical implant into the body or (b) support or sustain life, and (c) whose failure to perform properly used in accordance with instructions for use provided in the labeling, can be reasonably expected to result in a significant injury of the user.
2. A critical component in any component of a life support, device, or system whose failure to perform can be reasonably expected to cause the failure of the life support device or system, or to affect its safety or effectiveness.

ANTI-COUNTERFEITING POLICY

Fairchild Semiconductor Corporation's Anti-Counterfeiting Policy. Fairchild's Anti-Counterfeiting Policy is also stated on our external website, www.fairchildsemi.com, under Sales Support.

Counterfeiting of semiconductor parts is a growing problem in the industry. All manufacturers of semiconductor products are experiencing counterfeiting of their parts. Customers who inadvertently purchase counterfeit parts experience many problems such as loss of brand reputation, substandard performance, failed applications, and increased cost of production and manufacturing delays. Fairchild is taking strong measures to protect ourselves and our customers from the proliferation of counterfeit parts. Fairchild strongly encourages customers to purchase Fairchild parts either directly from Fairchild or from Authorized Fairchild Distributors who are listed by country on our web page cited above. Products customers buy either from Fairchild directly or from Authorized Fairchild Distributors are genuine parts, have full traceability, meet Fairchild's quality standards for handling and storage and provide access to Fairchild's full range of up-to-date technical and product information. Fairchild and our Authorized Distributors will stand behind all warranties and will appropriately address any warranty issues that may arise. Fairchild will not provide any warranty coverage or other assistance for parts bought from Unauthorized Sources. Fairchild is committed to combat this global problem and encourage our customers to do their part in stopping this practice by buying direct or from authorized distributors.

PRODUCT STATUS DEFINITIONS

Definition of Terms

Datasheet Identification	Product Status	Definition
Advance Information	Formative / In Design	Datasheet contains the design specifications for product development. Specifications may change in any manner without notice.
Preliminary	First Production	Datasheet contains preliminary data; supplementary data will be published at a later date. Fairchild Semiconductor reserves the right to make changes at any time without notice to improve design.
No Identification Needed	Full Production	Datasheet contains final specifications. Fairchild Semiconductor reserves the right to make changes at any time without notice to improve the design.
Obsolete	Not In Production	Datasheet contains specifications on a product that is discontinued by Fairchild Semiconductor. The datasheet is for reference information only.

Rev. 149