

PM-111/PM-211

FEATURES

- High Output Drive 50mA
- Low Input Bias Current 50nA Max
- Low Offset Voltage 3mV Max
- Differential Input Voltage Range $\pm 30V$
- Logic Outputs Compatible with Bipolar and CMOS
- Fully-Specified at All Temperatures
- Available in Die Form

ORDERING INFORMATION [†]

V _{OS} MAX (mV)	PACKAGE				OPERATING TEMPERATURE RANGE	
	TO-99	CERDIP	PLASTIC 8-PIN	SO 8-PIN		LCC 20-CONTACT
3.0	PM111J*	PM111Y*	-	-	PM111RC/883	MIL
3.0	-	PM111Z*	-	-	-	MIL
3.0	PM211J	PM211Y	-	-	-	IND
3.0	-	PM211Z	-	-	-	IND
3.0	-	-	PM211P	PM211S	-	XIND

* For devices processed in total compliance to MIL-STD-883, add /883 after part number. Consult factory for 883 data sheet.

[†] Burn-in is available on commercial and industrial temperature range parts in CerDIP, plastic DIP, and TO-can packages.

GENERAL DESCRIPTION

The PM-111/PM-211 are voltage comparators featuring low input bias and offset currents, high-differential voltage ranges, and wide-supply voltage ranges. The inputs and outputs can be isolated from system ground, and the output can drive loads referred to ground or either supply voltage. Strobing and offset balancing are available and the outputs can be wire OR'ed.

SIMPLIFIED SCHEMATIC

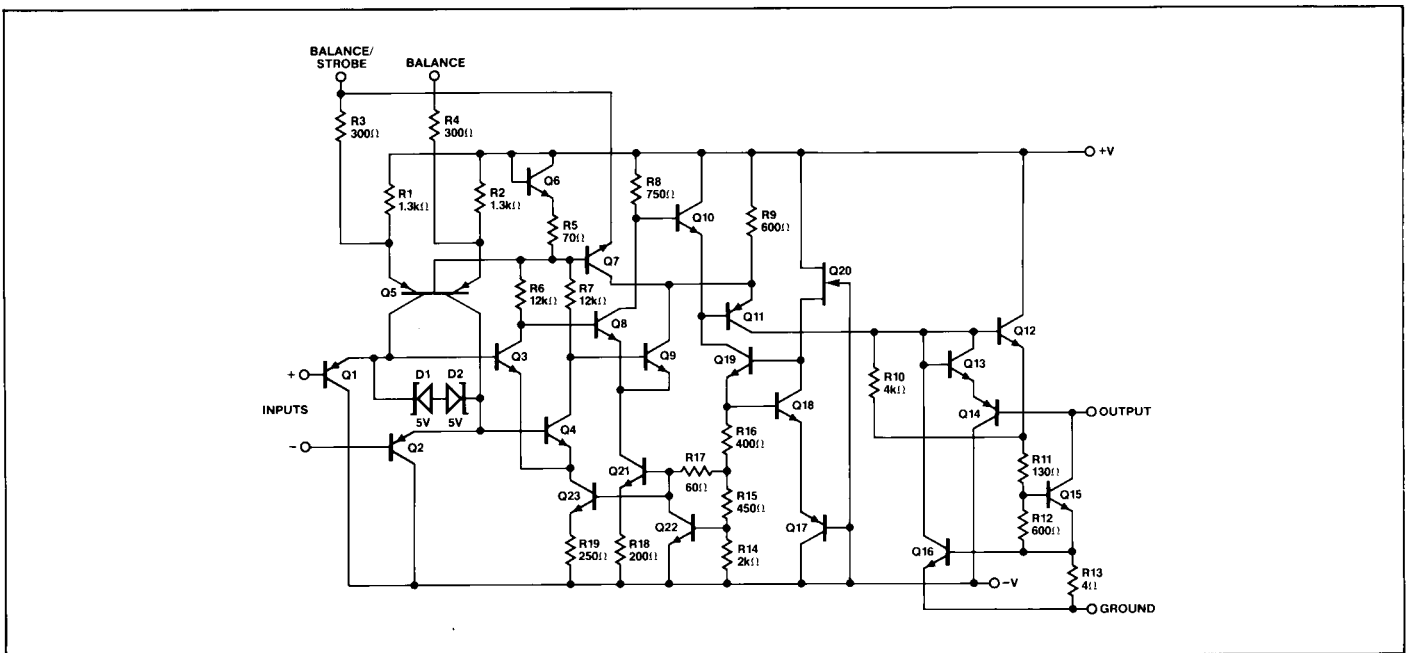

PIN CONNECTIONS

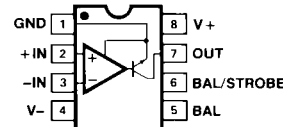

HERMETIC MINI-DIP
(Z-Suffix)

8-PIN PLASTIC
(P-Suffix)

8-PIN SO
(S-Suffix)

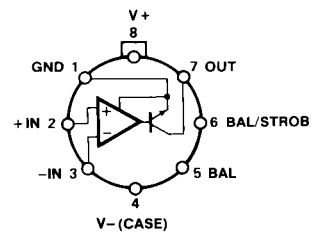

TO-99
(J-Suffix)

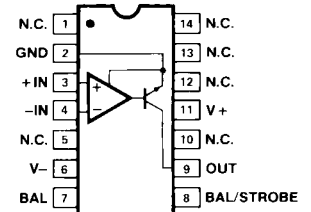

14-PIN HERMETIC DIP
(Y-Suffix)

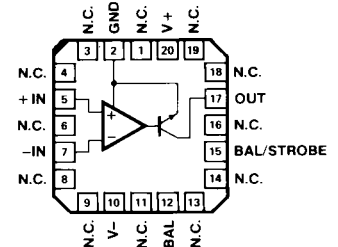

PM-111RC/883
LCC
(RC-Suffix)

PM-111/PM-211

ABSOLUTE MAXIMUM RATINGS (Note 1)

Total Supply Voltage, V_+ to V_-	36V
Output to Negative Supply Voltage	50V
Ground to Negative Supply Voltage	30V
Strobe Pin Voltage	$V_+ - 5V$
Differential Input Voltage	$\pm 30V$
Input Voltage (Note 2)	$\pm 15V$
Output Short-Circuit Duration	10s
Operating Temperature Range	
PM-111	-55°C to $+125^\circ\text{C}$
PM-211 (J, Y, Z)	-25°C to $+85^\circ\text{C}$
PM-211S/PM-211P	-40°C to $+85^\circ\text{C}$
Junction Temperature (T_j)	-65°C to $+150^\circ\text{C}$
Storage Temperature Range	-65°C to $+150^\circ\text{C}$
Lead Temperature (Soldering, 10 sec)	300°C

www.DataSheet4U.com

PACKAGE TYPE	θ_{JA} (Note 3)	θ_{JC}	UNITS
TO-99 (J)	150	18	$^\circ\text{C/W}$
14-Pin Hermetic DIP (Y)	108	16	$^\circ\text{C/W}$
8-Pin Hermetic DIP (Z)	148	16	$^\circ\text{C/W}$
8-Pin Plastic DIP (P)	103	43	$^\circ\text{C/W}$
20-Contact LCC (RC)	98	38	$^\circ\text{C/W}$
8-Pin SO (S)	158	43	$^\circ\text{C/W}$

NOTES:

1. Absolute maximum ratings apply to both DICE and packaged parts, unless otherwise noted.
2. Rating applies to $V_S = \pm 15V$. The positive input-voltage limit is 30V above the negative supply. The negative input-voltage limit is equal to the negative supply or 30V below the positive supply, whichever is less.
3. θ_{JA} is specified for worst case mounting conditions, i.e., θ_{JA} is specified for device in socket for TO, CerDIP, P-DIP, and LCC packages; θ_{JA} is specified for device soldered to printed circuit board for SO package.

ELECTRICAL CHARACTERISTICS at $V_S = \pm 15V$, ground pin at ground and $T_A = 25^\circ\text{C}$, unless otherwise noted.

PARAMETER	SYMBOL	CONDITIONS	PM-111/PM-211			UNITS
			MIN	TYP	MAX	
Input Offset Voltage	V_{OS}	(Note 1)	—	0.75	3.0	mV
Input Offset Current	I_{OS}	(Note 1)	—	0.3	5.0	nA
Input Bias Current	I_B	(Note 1)	—	25	50	nA
Voltage Gain (Emitter)	A_{VE}	(Note 2)	—	75	—	V/mV
Voltage Gain (Collector)	A_{VC}		—	200	—	V/mV
Response Time	t_r	$R_L = 500\Omega$ (tied to V_+) $V_{OD} = 5mV$ (Note 3)	—	180	—	ns
Saturation Voltage	V_{OL}	$V_{IN} \leq -5mV$ $I_{OUT} = 50mA$	—	0.68	1.0	V
Output Leakage Current	I_{CEX}	$V_{IN} \geq +5mV$ $V_{OUT} = 50V$	—	5	15	nA
Positive Supply Current	I_{SY+}		—	3.3	5	mA
Negative Supply Current	I_{SY-}		—	2.4	4	mA
Input Voltage Range	IVR		-14.5 +13	-14.8 +14	—	V

NOTES:

1. The offset voltage, offset current, and bias current given are the maximum values required to drive the collector output to within 1V of the supplies with a 7.5k Ω load. These parameters define an error band and take into account the worst case effects of voltage gain and input impedance.
2. Average of A_{V+} and A_{V-} over a $\pm 10V$ output range measured at the emitter.
3. The response time specified is for a 100mV input step with a 5mV overdrive and is the time required for the slowest edge. The slowest response occurs at the highest temperature of operation.

ELECTRICAL CHARACTERISTICS at $V_S = \pm 15V$, ground pin at ground and $-25^\circ C \leq T_A \leq +85^\circ C$ for PM-211J, Z and Y, $-40^\circ C \leq T_A \leq +85^\circ C$ for PM-211P and S, unless otherwise noted.

PARAMETER	SYMBOL	CONDITIONS	PM-211			UNITS
			MIN	TYP	MAX	
Input Offset Voltage	V_{OS}	(Note 1)	—	0.8	3.0	mV
Input Offset Current	I_{OS}	(Note 1)	—	0.3	7	nA
Input Bias Current	I_B	(Note 1)	—	25	100	nA
Voltage Gain (Emitter)	A_{VE}	(Note 2)	—	35	—	V/mV
Response Time	t_r	$R_L = 500\Omega$ (tied to V+) $V_{OD} = 5mV$ (Note 3)	—	240	—	ns
Saturation Voltage	V_{OL}	$V_{IN} \leq -5mV$ $I_{OUT} = 50mA$	—	0.8	1.5	V
Output Leakage Current	I_{CEX}	$V_{IN} \geq +5mV$ $V_{OUT} = 50V$	—	10	100	nA
Positive Supply Current	I_{SY+}		—	4	6	mA
Negative Supply Current	I_{SY-}		—	2.8	5	mA
Input Voltage Range	IVR		-14.5 13	-14.8 14	—	V

ELECTRICAL CHARACTERISTICS at $V_S = \pm 15V$, ground pin at ground and $-55^\circ C \leq T_A \leq +125^\circ C$, unless otherwise noted.

PARAMETER	SYMBOL	CONDITIONS	PM-111			UNITS
			MIN	TYP	MAX	
Input Offset Voltage	V_{OS}	(Note 1)	—	0.8	3.0	mV
Input Offset Current	I_{OS}	(Note 1)	—	0.3	10	nA
Input Bias Current	I_B	(Note 1)	—	25	100	nA
Voltage Gain (Emitter)	A_{VE}	(Note 2)	—	20	—	V/mV
Response Time	t_r	$R_L = 500\Omega$ (tied to V+) $V_{OD} = 5mV$ (Note 3)	—	420	—	ns
Saturation Voltage	V_{OL}	$V_{IN} \leq -5mV$ $I_{OUT} = 50mA$	—	0.62	1.5	V
Output Leakage Current	I_{CEX}	$V_{IN} \geq +5mV$ $V_{OUT} = 50V$	—	145	500	nA
Positive Supply Current	I_{SY+}		—	4.2	6	mA
Negative Supply Current	I_{SY-}		—	3	5	mA
Input Voltage Range	IVR		-14.5 +13	-14.8 +14	—	V

NOTES:

1. The offset voltage, offset current, and bias current given are the maximum values required to drive the collector output to within 1V of the supplies with a 7.5k Ω load. These parameters define an error band and take into account the worst case effects of voltage gain and input impedance.
2. Average of A_{V+} and A_{V-} over a $\pm 10V$ output range measured at the emitter.
3. The response time specified is for a 100mV input step with a 5mV overdrive and is the time required for the slowest edge. The slowest response occurs at the highest temperature of operation.

PM-111/PM-211

DICE CHARACTERISTICS

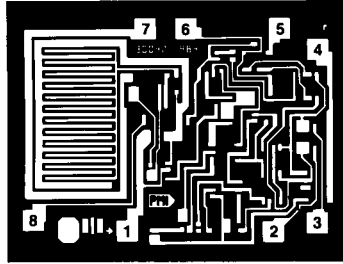

**DIE SIZE 0.066 × 0.050 inch, 3300 sq. mils
(1.68 × 1.27mm, 2.13 sq. mm)**

1. GROUND
2. +IN
3. -IN
4. V-
5. BALANCE
6. BALANCE/STROBE
7. OUTPUT
8. V+

www.DataSheet4U.com

WAFER TEST LIMITS at $V_S = \pm 15V$, $T_A = 25^\circ C$ and ground pin at ground for PM-111GBC, $T_A = 125^\circ C$ for PM-111GTBC, unless otherwise noted.

PARAMETER	SYMBOL	CONDITIONS	PM-111GTBC	PM-111GBC	UNITS
			LIMIT	LIMIT	
Input Offset Voltage	V_{OS}	(Note 1)	3	3	mV MAX
Input Offset Current	I_{OS}	(Note 1)	10	5	nA MAX
Input Bias Current	I_B	(Note 1)	100	50	nA MAX
Saturation Voltage	V_{OL}		1.5	1.0	V MAX
Output Leakage Current	I_{CEX}	$V_{IN} \geq +5mV$ $V_{OUT} = 50V$	500	15	nA MAX
Input Voltage Range	IVR		± 13	—	V MIN
Positive Supply Current	I_{SY+}		6	5	mA MAX
Negative Supply Current	I_{SY-}		5	4	mA MAX

NOTE:

Electrical tests are performed at wafer probe to the limits shown. Due to variations in assembly methods and normal yield loss, yield after packaging is not guaranteed for standard product dice. Consult factory to negotiate specifications based on dice lot qualification through sample lot assembly and testing.

TYPICAL ELECTRICAL CHARACTERISTICS at $V_S = \pm 15V$, $T_A = 25^\circ C$ and ground pin at ground for PM-111GBC, $T_A = 125^\circ C$ for PM-111GTBC, unless otherwise noted.

PARAMETER	SYMBOL	CONDITIONS	PM-111GTBC	PM-111GBC	UNITS
			TYPICAL	TYPICAL	
Voltage Gain (Emitter)	A_{VE}	(Note 2)	20	75	V/mV
Response Time	t_r	(Note 3)	420	180	ns

NOTES:

1. The offset voltage, offset current, and bias current given are the maximum values required to drive the collector output to within 1V of the supplies with a 7.5k Ω load. These parameters define an error band and take into account the worst case effects of voltage gain and input impedance.
2. Average of A_{V+} and A_{V-} over a $\pm 10V$ output range measured at the emitter.
3. The response time specified is for a 100mV input step with a 5mV overdrive and is the time required for the slowest edge. The slowest response occurs at the highest temperature of operation.

TYPICAL PERFORMANCE CHARACTERISTICS

INPUT OFFSET VOLTAGE vs TEMPERATURE

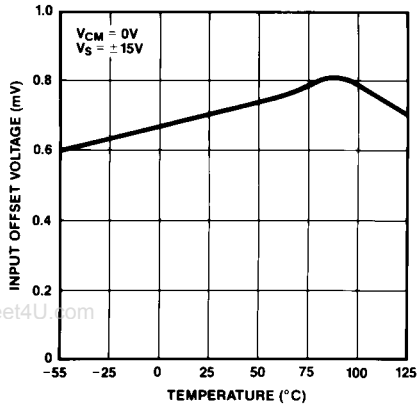

INPUT OFFSET VOLTAGE vs TEMPERATURE

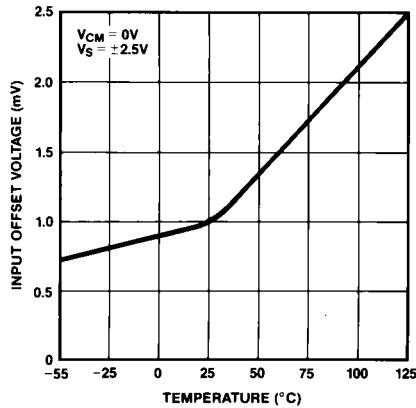

INPUT BIAS CURRENT vs TEMPERATURE

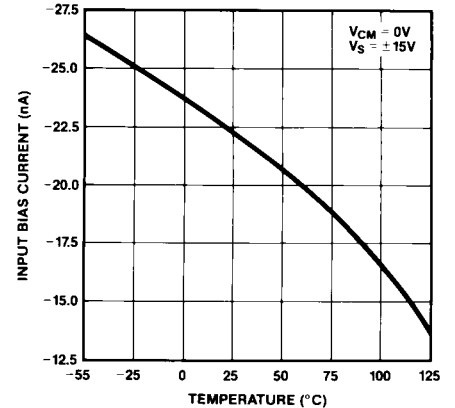

INPUT BIAS CURRENT vs COMMON-MODE VOLTAGE

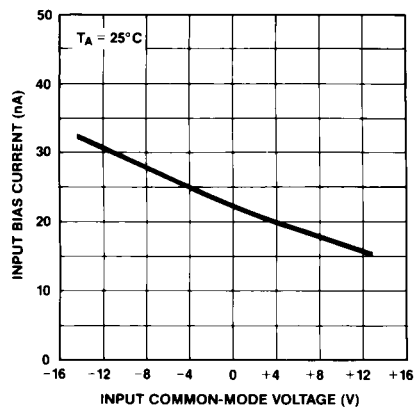

INPUT OFFSET CURRENT vs TEMPERATURE

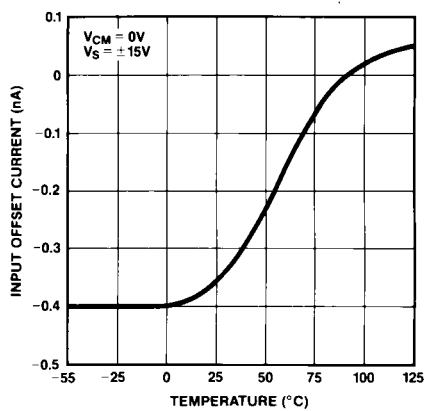

COMMON-MODE LIMITS vs TEMPERATURE

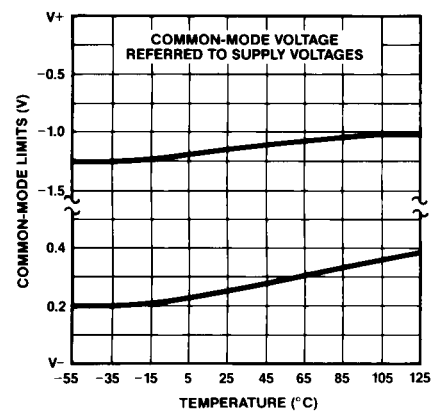

TRANSFER FUNCTION

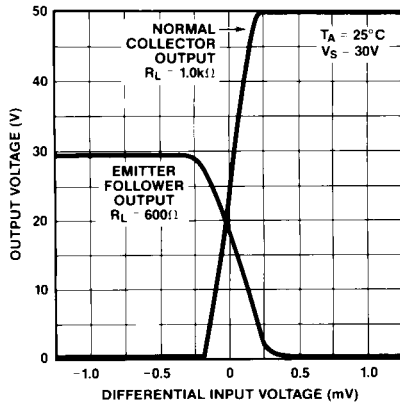

SATURATION VOLTAGE vs TEMPERATURE

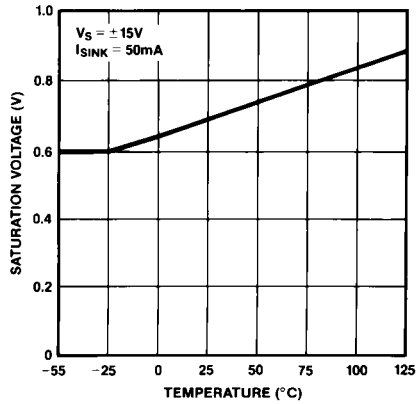

SATURATION VOLTAGE vs SINK CURRENT

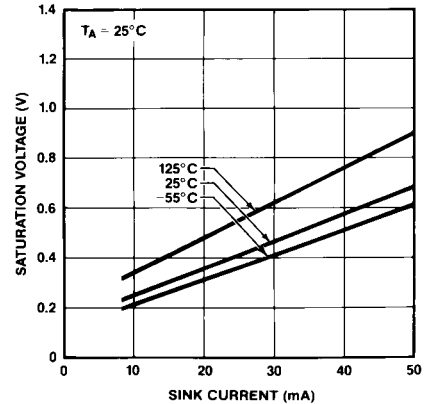

3

www.DataSheet4U.com

PM-111/PM-211

TYPICAL PERFORMANCE CHARACTERISTICS

RESPONSE TIME FOR VARIOUS INPUT OVERDRIVES

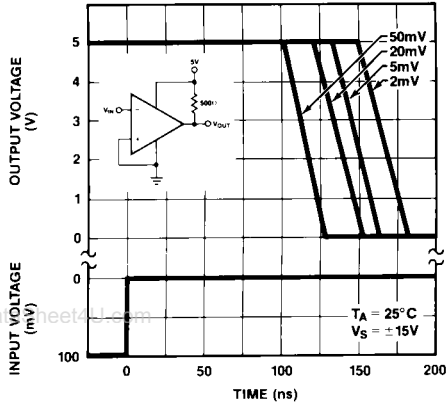

RESPONSE TIME FOR VARIOUS INPUT OVERDRIVES

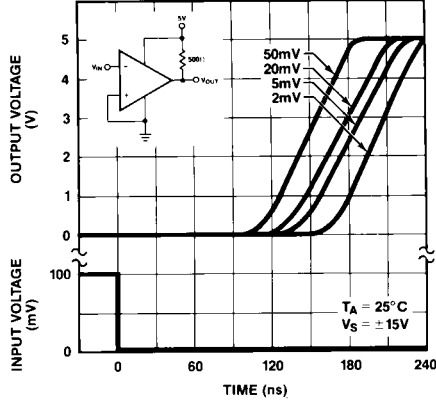

RESPONSE TIME FOR VARIOUS INPUT OVERDRIVES

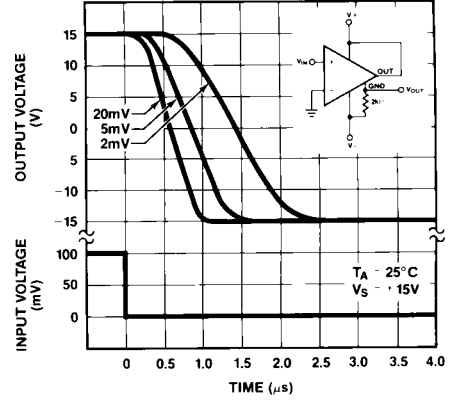

RESPONSE TIME FOR VARIOUS INPUT OVERDRIVES

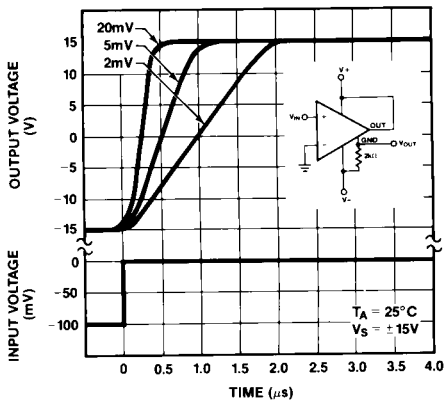

COMMON-MODE REJECTION RATIO vs TEMPERATURE

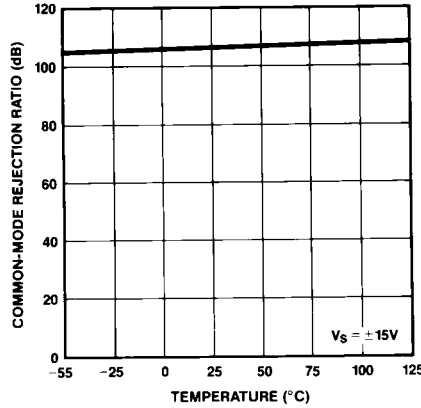

TOTAL SUPPLY CURRENT vs TOTAL SUPPLY VOLTAGE

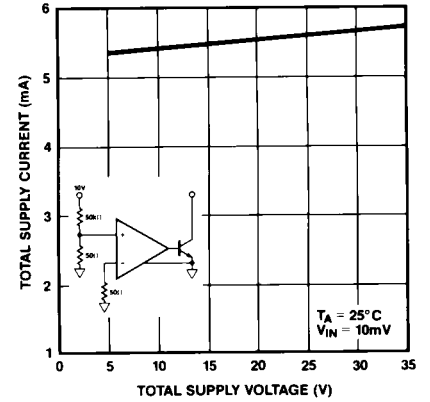

SUPPLY CURRENT vs TEMPERATURE

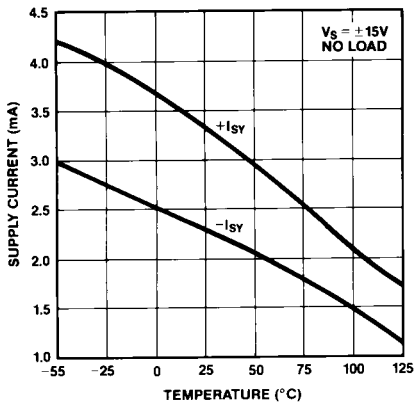

BURN-IN CIRCUIT

