

SWITCHMODE™

NPN Bipolar Power Transistor

For Switching Power Supply Applications

The BUL146/BUL146F have an applications specific state-of-the-art die designed for use in fluorescent electric lamp ballasts to 130 Watts and in Switchmode Power supplies for all types of electronic equipment. These high voltage/high speed transistors offer the following:

- Improved Efficiency Due to Low Base Drive Requirements:
 - High and Flat DC Current Gain
 - Fast Switching
 - No Coil Required in Base Circuit for Turn-Off (No Current Tail)
- Full Characterization at 125°C
- Two Packages Choices: Standard TO220 or Isolated TO220
- Parametric Distributions are Tight and Consistent Lot-to-Lot
- BUL146F, Case 221D, is UL Recognized to 3500 V_{RMS}: File # E69369

MAXIMUM RATINGS

Rating	Sym- bol	BUL146	BUL146F	Unit
Collector-Emitter Sustaining Voltage	V _{CEO}	400		Vdc
Collector-Emitter Breakdown Voltage	V _{CES}	700		Vdc
Emitter-Base Voltage	V _{EBO}	9.0		Vdc
Collector Current – Continuous	I _C	6.0		Adc
– Peak(1)	I _{CM}	15		
Base Current – Continuous	I _B	4.0		Adc
– Peak(1)	I _{BM}	8.0		
RMS Isolation Voltage: (2) (for 1 sec, R.H. ≤ 30%, T _C = 25°C)	V _{ISOL1} V _{ISOL2} V _{ISOL3}	– – –	4500 3500 1500	Volts
Total Device Dissipation Derate above 25°C	P _D	100 0.8	40 0.32	Watts W/°C
Operating and Storage Temperature	T _J , T _{stg}	– 65 to 150		°C

THERMAL CHARACTERISTICS

Rating	Sym- bol	BUL146	BUL146F	Unit
Thermal Resistance – Junction to Case – Junction to Ambient	R _{θJC} R _{θJA}	1.25 62.5	3.125 62.5	°C/W
Maximum Lead Temperature for Soldering Purposes: 1/8" from Case for 5 Seconds	T _L	260		°C

BUL146 BUL146F

POWER TRANSISTOR
6.0 AMPERES
700 VOLTS
40 and 100 WATTS

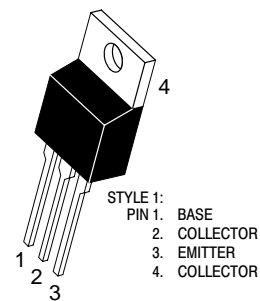

BUL146
CASE 221A-09
TO-220AB

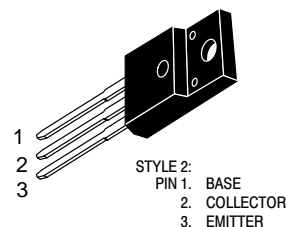

CASE 221D-02
ISOLATED TO-220 TYPE
BUL146F

BUL146 BUL146F

ELECTRICAL CHARACTERISTICS (T_C = 25°C unless otherwise noted)

Characteristic	Symbol	Min	Typ	Max	Unit
----------------	--------	-----	-----	-----	------

OFF CHARACTERISTICS

Collector–Emitter Sustaining Voltage (I _C = 100 mA, L = 25 mH)	V _{CEO(sus)}	400	–	–	Vdc
Collector Cutoff Current (V _{CE} = Rated V _{CEO} , I _B = 0)	I _{CEO}	–	–	100	μAdc
Collector Cutoff Current (V _{CE} = Rated V _{CES} , V _{EB} = 0) (T _C = 125°C)	I _{CES}	–	–	100	μAdc
		(V _{CE} = 500 V, V _{EB} = 0) (T _C = 125°C)	–	–	
Emitter Cutoff Current (V _{EB} = 9.0 Vdc, I _C = 0)	I _{EBO}	–	–	100	μAdc

(1) Pulse Test: Pulse Width = 5.0 ms, Duty Cycle ≤ 10%.

ELECTRICAL CHARACTERISTICS – (T_C = 25°C unless otherwise noted)

Characteristic	Symbol	Min	Typ	Max	Unit
----------------	--------	-----	-----	-----	------

ON CHARACTERISTICS

Base–Emitter Saturation Voltage (I _C = 1.3 Adc, I _B = 0.13 Adc) (I _C = 3.0 Adc, I _B = 0.6 Adc)	V _{BE(sat)}	–	0.82	1.1	Vdc
		–	0.93	1.25	
Collector–Emitter Saturation Voltage (I _C = 1.3 Adc, I _B = 0.13 Adc) (T _C = 125°C) (I _C = 3.0 Adc, I _B = 0.6 Adc) (T _C = 125°C)	V _{CE(sat)}	–	0.22	0.5	Vdc
		–	0.20	0.5	
		–	0.30	0.7	
		–	0.30	0.7	
DC Current Gain (I _C = 0.5 Adc, V _{CE} = 5.0 Vdc) (T _C = 125°C) (I _C = 1.3 Adc, V _{CE} = 1.0 Vdc) (T _C = 125°C) (I _C = 3.0 Adc, V _{CE} = 1.0 Vdc) (T _C = 125°C) (I _C = 10 mAdc, V _{CE} = 5.0 Vdc)	h _{FE}	14	–	34	–
		–	30	–	
		12	20	–	
		12	20	–	
		8.0	13	–	
7.0	12	–			
10	20	–			

DYNAMIC CHARACTERISTICS

Current Gain Bandwidth (I _C = 0.5 Adc, V _{CE} = 10 Vdc, f = 1.0 MHz)	f _T	–	14	–	MHz				
Output Capacitance (V _{CB} = 10 Vdc, I _E = 0, f = 1.0 MHz)	C _{OB}	–	95	150	pF				
Input Capacitance (V _{EB} = 8.0 V)	C _{IB}	–	1000	1500	pF				
Dynamic Saturation Voltage: Determined 1.0 μs and 3.0 μs respectively after rising I _{B1} reaches 90% of final I _{B1} (see Figure 18)	(I _C = 1.3 Adc I _{B1} = 300 mAdc V _{CC} = 300 V)	1.0 μs	(T _C = 125°C)	V _{CE(dsat)}	–	2.5	–	V	
		3.0 μs	(T _C = 125°C)		–	6.5	–		
		(I _C = 3.0 Adc I _{B1} = 0.6 Adc V _{CC} = 300 V)	1.0 μs		(T _C = 125°C)	–	0.6		–
			3.0 μs		(T _C = 125°C)	–	2.5		–
		(I _C = 3.0 Adc I _{B1} = 0.6 Adc V _{CC} = 300 V)	1.0 μs		(T _C = 125°C)	–	3.0		–
			3.0 μs		(T _C = 125°C)	–	7.0		–
		(I _C = 3.0 Adc I _{B1} = 0.6 Adc V _{CC} = 300 V)	0.75		–	–	–		–
			1.4		–	–	–		–

BUL146 BUL146F

SWITCHING CHARACTERISTICS: Resistive Load (D.C. ≤ 10%, Pulse Width = 20 μs)

Turn-On Time	(I _C = 1.3 Adc, I _{B1} = 0.13 Adc I _{B2} = 0.65 Adc, V _{CC} = 300 V) (T _C = 125°C)	t _{on}	–	100	200	ns
Turn-Off Time		t _{off}	–	90	–	–
Turn-On Time	(I _C = 3.0 Adc, I _{B1} = 0.6 Adc I _{B1} = 1.5 Adc, V _{CC} = 300 V) (T _C = 125°C)	t _{on}	–	1.35	2.5	μs
Turn-Off Time		t _{off}	–	1.90	–	–
Turn-On Time	(I _C = 3.0 Adc, I _{B1} = 0.6 Adc I _{B1} = 1.5 Adc, V _{CC} = 300 V) (T _C = 125°C)	t _{on}	–	90	150	ns
Turn-Off Time		t _{off}	–	100	–	–
Turn-On Time	(I _C = 3.0 Adc, I _{B1} = 0.6 Adc I _{B1} = 1.5 Adc, V _{CC} = 300 V) (T _C = 125°C)	t _{on}	–	1.7	2.5	μs
Turn-Off Time		t _{off}	–	2.1	–	–

SWITCHING CHARACTERISTICS: Inductive Load (V_{clamp} = 300 V, V_{CC} = 15 V, L = 200 μH)

Fall Time	(I _C = 1.3 Adc, I _{B1} = 0.13 Adc I _{B2} = 0.65 Adc) (T _C = 125°C)	t _{fi}	–	115	200	ns
Storage Time		t _{si}	–	120	–	–
Crossover Time		t _c	–	1.35	2.5	μs
Fall Time	(I _C = 1.3 Adc, I _{B1} = 0.13 Adc I _{B2} = 0.65 Adc) (T _C = 125°C)	t _{fi}	–	1.75	–	–
Storage Time		t _{si}	–	200	350	ns
Crossover Time		t _c	–	210	–	–
Fall Time	(I _C = 3.0 Adc, I _{B1} = 0.6 Adc I _{B2} = 1.5 Adc) (T _C = 125°C)	t _{fi}	–	85	150	ns
Storage Time		t _{si}	–	100	–	–
Crossover Time		t _c	–	1.75	2.5	μs
Fall Time	(I _C = 3.0 Adc, I _{B1} = 0.6 Adc I _{B2} = 1.5 Adc) (T _C = 125°C)	t _{fi}	–	2.25	–	–
Storage Time		t _{si}	–	175	300	ns
Crossover Time		t _c	–	200	–	–
Fall Time	(I _C = 3.0 Adc, I _{B1} = 0.6 Adc I _{B2} = 0.6 Adc) (T _C = 125°C)	t _{fi}	80	–	180	ns
Storage Time		t _{si}	–	210	–	–
Crossover Time		t _c	–	2.6	–	3.8
Storage Time	(I _C = 3.0 Adc, I _{B1} = 0.6 Adc I _{B2} = 0.6 Adc) (T _C = 125°C)	t _{si}	–	4.5	–	–
Crossover Time		t _c	–	230	350	ns
Crossover Time	(I _C = 3.0 Adc, I _{B1} = 0.6 Adc I _{B2} = 0.6 Adc) (T _C = 125°C)	t _c	–	400	–	–

BUL146 BUL146F

TYPICAL STATIC CHARACTERISTICS

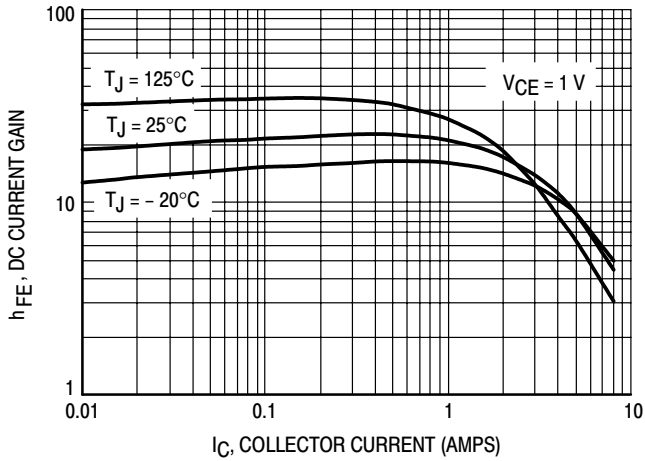

Figure 1. DC Current Gain @ 1 Volt

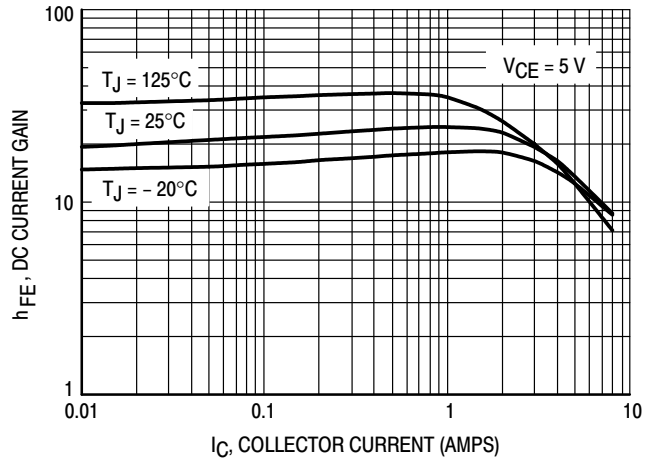

Figure 2. DC Current Gain @ 5 Volts

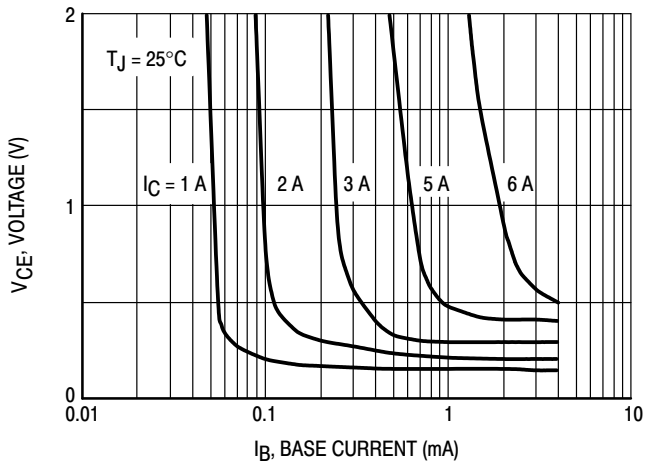

Figure 3. Collector Saturation Region

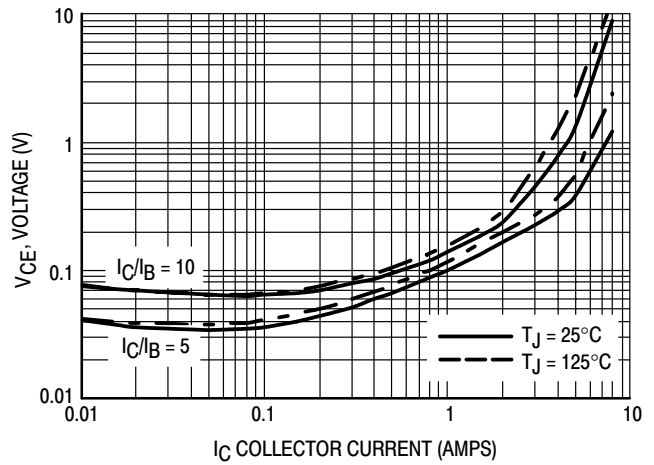

Figure 4. Collector-Emitter Saturation Voltage

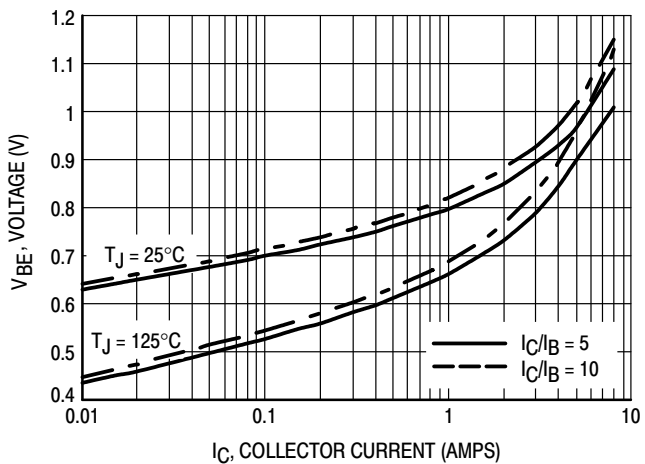

Figure 5. Base-Emitter Saturation Region

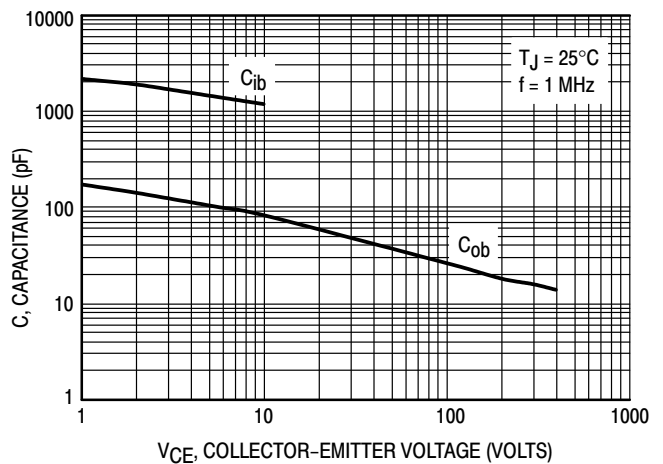

Figure 6. Capacitance

TYPICAL SWITCHING CHARACTERISTICS
($I_{B2} = I_C/2$ for all switching)

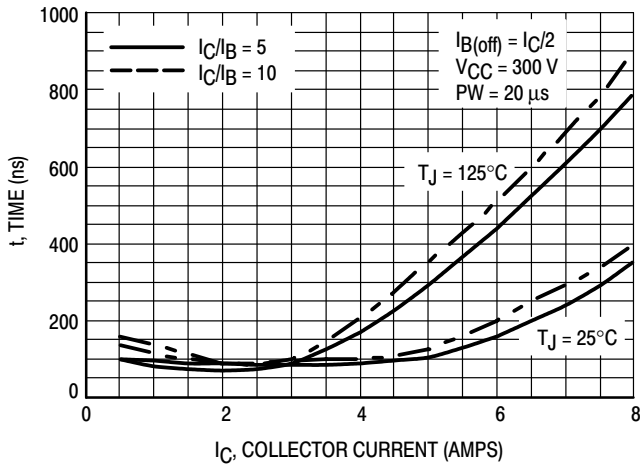

Figure 7. Resistive Switching, t_{on}

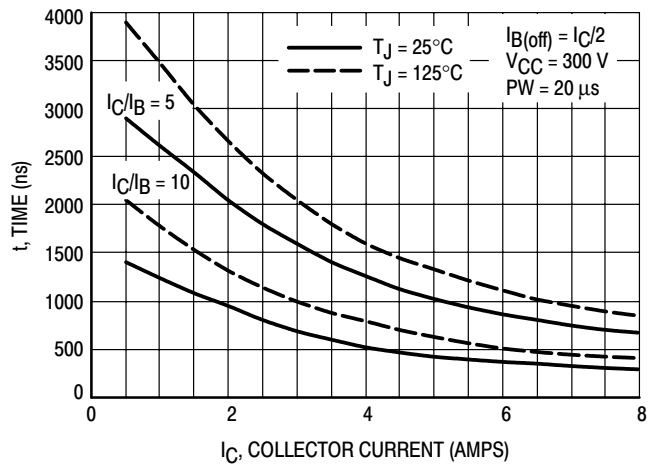

Figure 8. Resistive Switching, t_{off}

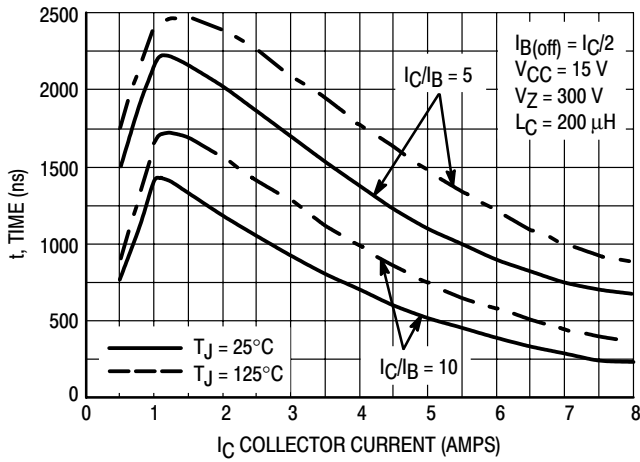

Figure 9. Inductive Storage Time, t_{sj}

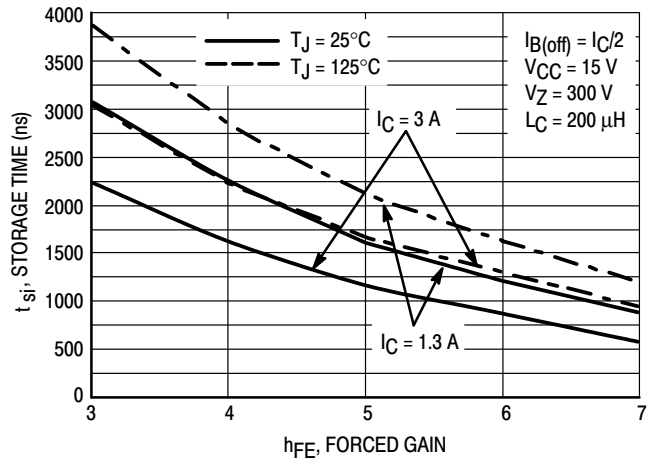

Figure 10. Inductive Storage Time, $t_{sj}(h_{FE})$

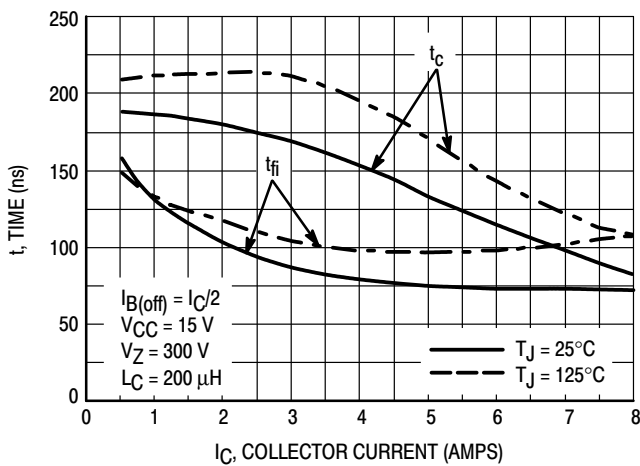

Figure 11. Inductive Switching, t_c and t_{fj}
 $I_C/I_B = 5$

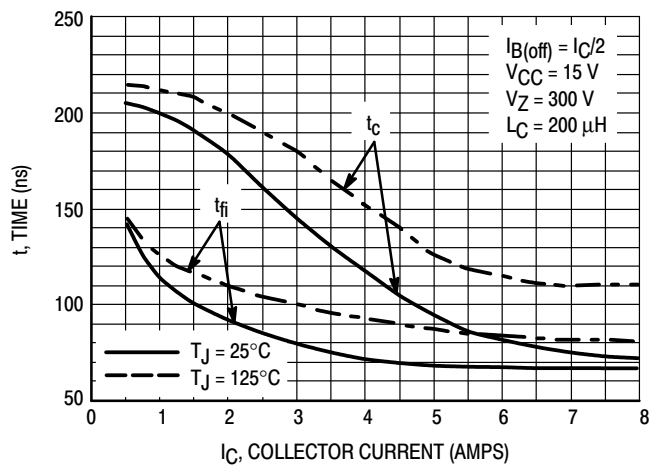

Figure 12. Inductive Switching, t_c and t_{fj}
 $I_C/I_B = 10$

BUL146 BUL146F

TYPICAL SWITCHING CHARACTERISTICS ($I_{B2} = I_C/2$ for all switching)

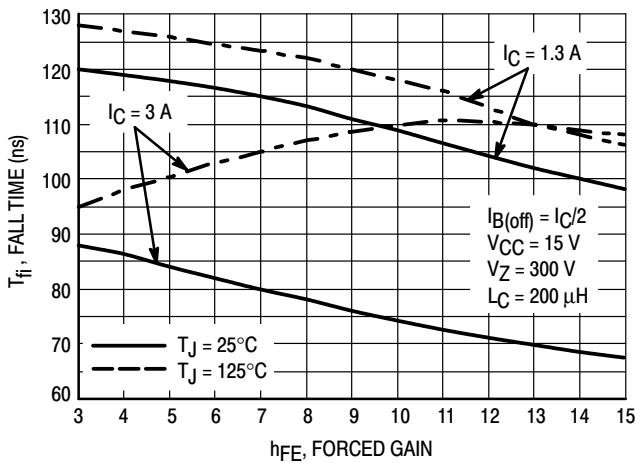

Figure 13. Inductive Fall Time

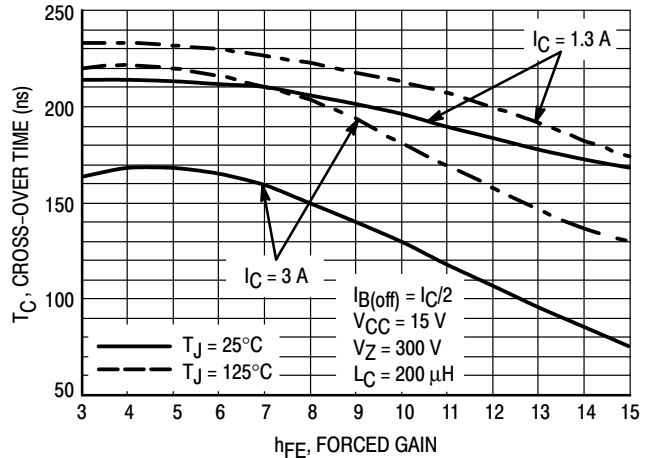

Figure 14. Inductive Cross-Over Time

GUARANTEED SAFE OPERATING AREA INFORMATION

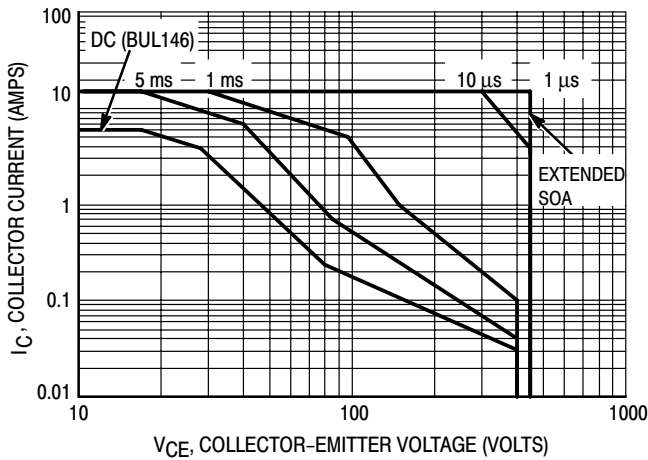

Figure 15. Forward Bias Safe Operating Area

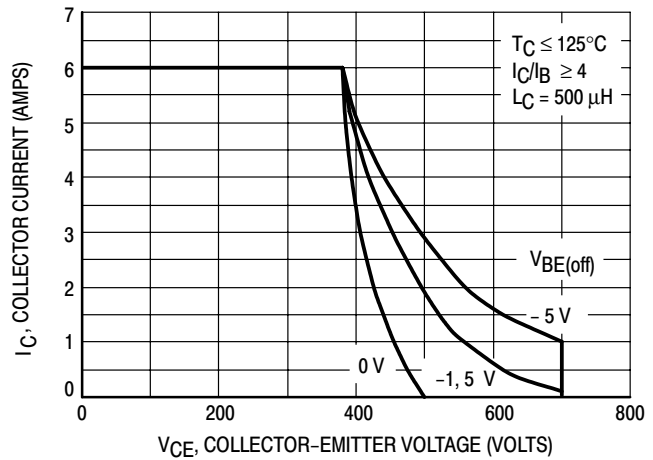

Figure 16. Reverse Bias Switching Safe Operating Area

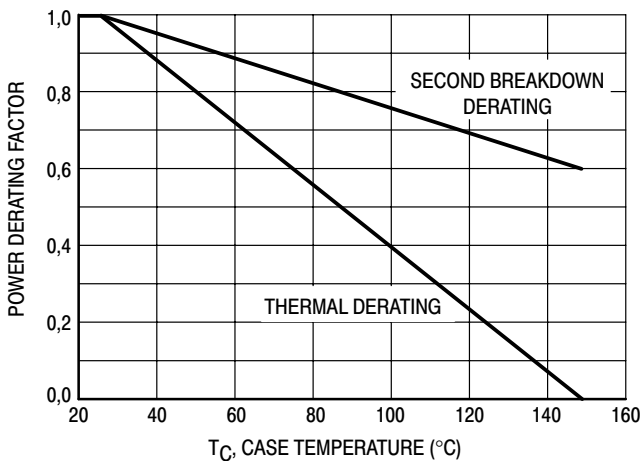

Figure 17. Forward Bias Power Derating

There are two limitations on the power handling ability of a transistor: average junction temperature and second breakdown. Safe operating area curves indicate $I_C - V_{CE}$ limits of the transistor that must be observed for reliable operation; i.e., the transistor must not be subjected to greater dissipation than the curves indicate. The data of Figure 15 is based on $T_C = 25^\circ\text{C}$; $T_{J(pk)}$ is variable depending on power level. Second breakdown pulse limits are valid for duty cycles to 10% but must be derated when $T_C > 25^\circ\text{C}$. Second breakdown limitations do not derate the same as thermal limitations. Allowable current at the voltages shown in Figure 15 may be found at any case temperature by using the appropriate curve on Figure 17. $T_{J(pk)}$ may be calculated from the data in Figure 20. At any case temperatures, thermal limitations will reduce the power that can be handled to values less than the limitations imposed by second breakdown. For inductive loads, high voltage and current must be sustained simultaneously during turn-off with the base-to-emitter junction reverse-biased. The safe level is specified as a reverse-biased safe operating area (Figure 16). This rating is verified under clamped conditions so that the device is never subjected to an avalanche mode.

BUL146 BUL146F

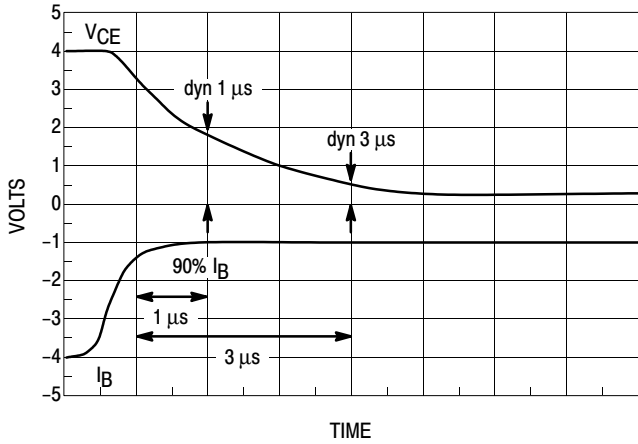

Figure 18. Dynamic Saturation Voltage Measurements

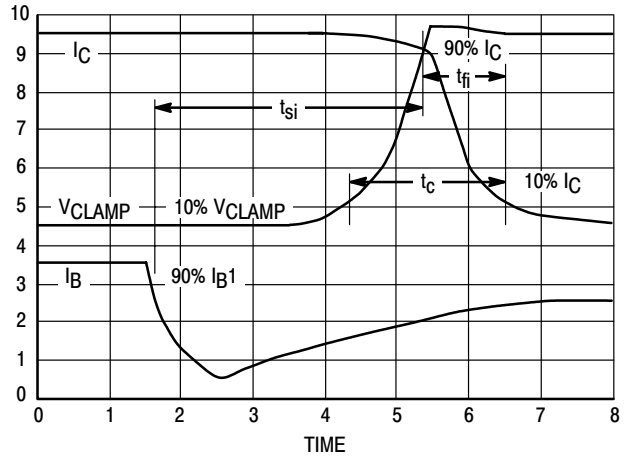
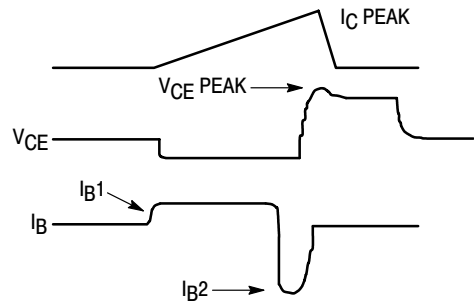
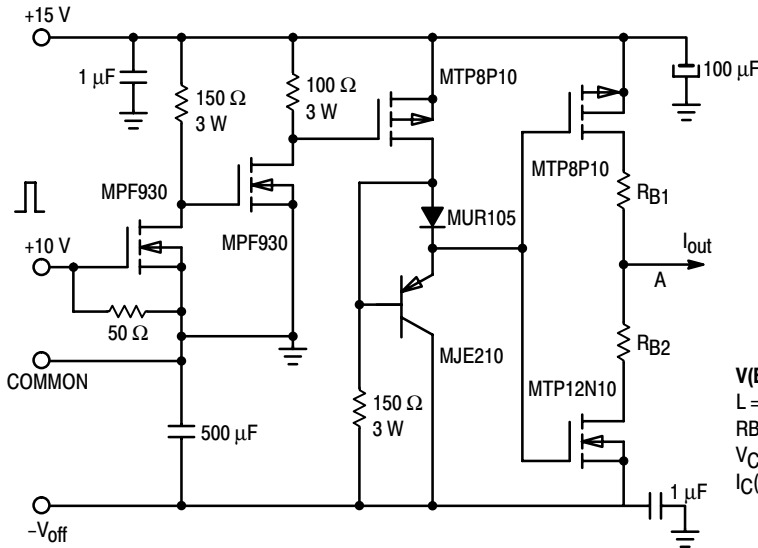

Figure 19. Inductive Switching Measurements



V(BR)CEO(sus)	INDUCTIVE SWITCHING	RBSOA
L = 10 mH	L = 200 μH	L = 500 μH
RB2 = ∞	RB2 = 0	RB2 = 0
VCC = 20 VOLTS	VCC = 15 VOLTS	VCC = 15 VOLTS
IC(pk) = 100 mA	RB1 SELECTED FOR DESIRED IB1	RB1 SELECTED FOR DESIRED IB1

Table 1. Inductive Load Switching Drive Circuit

TYPICAL THERMAL RESPONSE

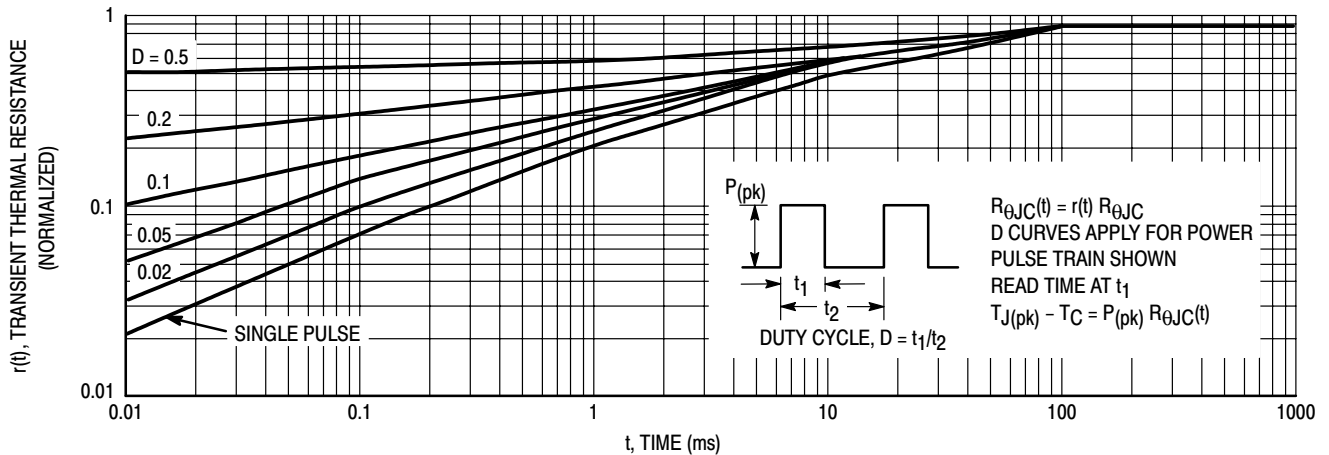

Figure 20. Typical Thermal Response ($Z_{\theta JC}(t)$) for BUL146

BUL146 BUL146F

TYPICAL THERMAL RESPONSE

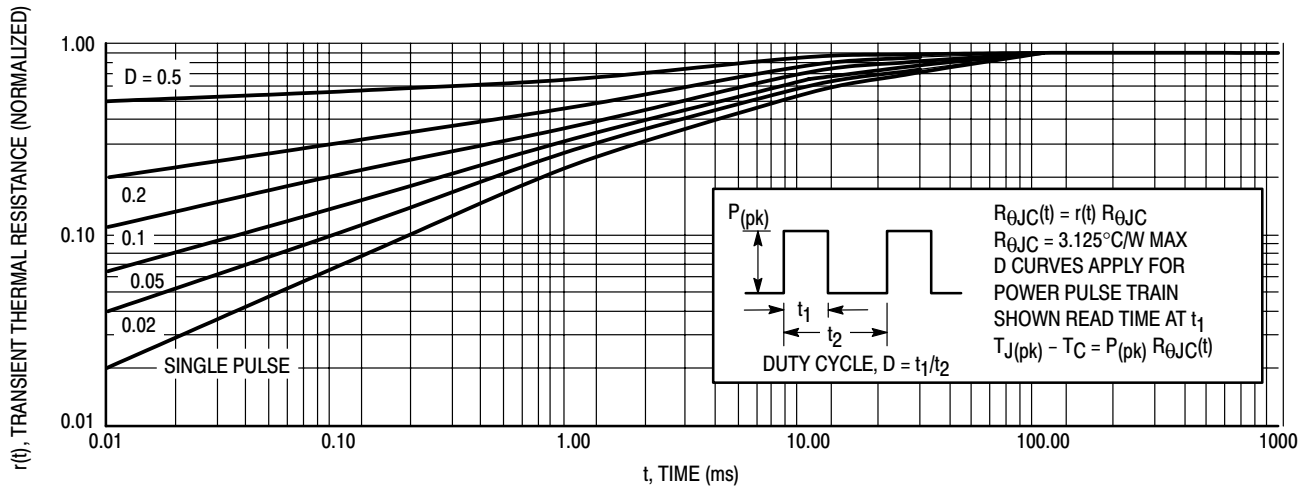

Figure 21. Typical Thermal Response for BUL146F

TEST CONDITIONS FOR ISOLATION TESTS*

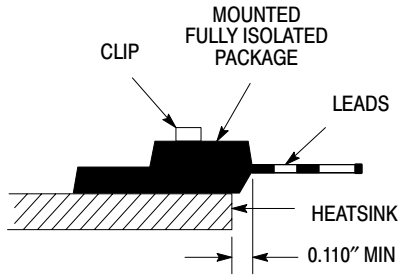

Figure 22a. Screw or Clip Mounting Position for Isolation Test Number 1

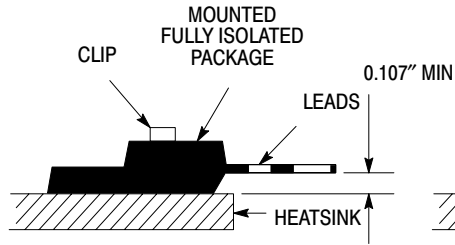

Figure 22b. Clip Mounting Position for Isolation Test Number 2

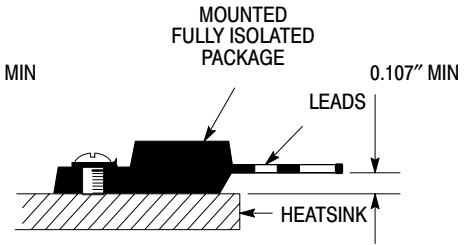

Figure 22c. Screw Mounting Position for Isolation Test Number 3

*Measurement made between leads and heatsink with all leads shorted together

MOUNTING INFORMATION**

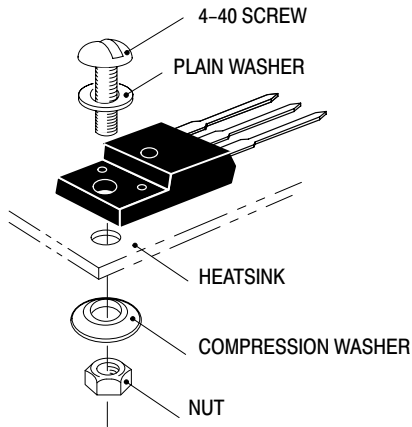

Figure 23a. Screw-Mounted

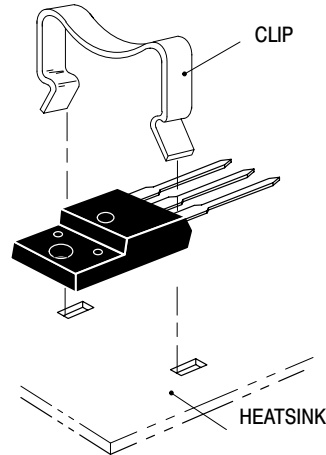

Figure 23b. Clip-Mounted

Figure 23. Typical Mounting Techniques for Isolated Package

Laboratory tests on a limited number of samples indicate, when using the screw and compression washer mounting technique, a screw torque of 6 to 8 in · lbs is sufficient to provide maximum power dissipation capability. The compression washer helps to maintain a constant pressure on the package over time and during large temperature excursions.

Destructive laboratory tests show that using a hex head 4-40 screw, without washers, and applying a torque in excess of 20 in · lbs will cause the plastic to crack around the mounting hole, resulting in a loss of isolation capability.

Additional tests on slotted 4-40 screws indicate that the screw slot fails between 15 to 20 in · lbs without adversely affecting the package. However, in order to positively ensure the package integrity of the fully isolated device, ON Semiconductor does not recommend exceeding 10 in · lbs of mounting torque under any mounting conditions.

** For more information about mounting power semiconductors see Application Note AN1040.

BUL146 BUL146F

PACKAGE DIMENSIONS

TO-220AB CASE 221A-09 ISSUE AA

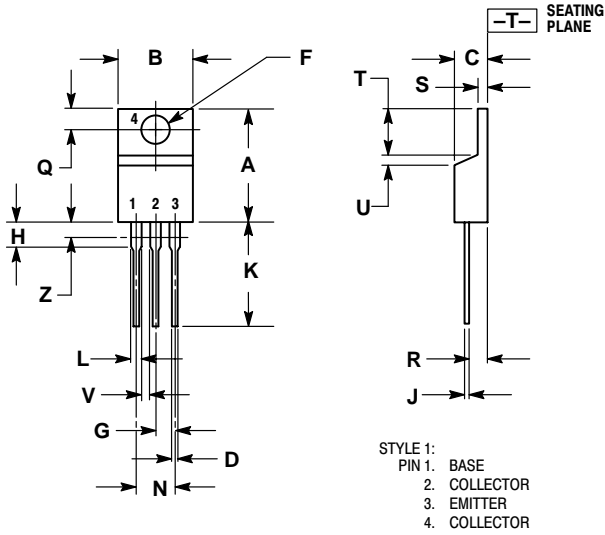

- NOTES:
1. DIMENSIONING AND TOLERANCING PER ANSI Y14.5M, 1982.
 2. CONTROLLING DIMENSION: INCH.
 3. DIMENSION Z DEFINES A ZONE WHERE ALL BODY AND LEAD IRREGULARITIES ARE ALLOWED.

DIM	INCHES		MILLIMETERS	
	MIN	MAX	MIN	MAX
A	0.570	0.620	14.48	15.75
B	0.380	0.405	9.66	10.28
C	0.160	0.190	4.07	4.82
D	0.025	0.035	0.64	0.88
F	0.142	0.147	3.61	3.73
G	0.095	0.105	2.42	2.66
H	0.110	0.155	2.80	3.93
J	0.018	0.025	0.46	0.64
K	0.500	0.562	12.70	14.27
L	0.045	0.060	1.15	1.52
N	0.190	0.210	4.83	5.33
Q	0.100	0.120	2.54	3.04
R	0.080	0.110	2.04	2.79
S	0.045	0.055	1.15	1.39
T	0.235	0.255	5.97	6.47
U	0.000	0.050	0.00	1.27
V	0.045	---	1.15	---
Z	---	0.080	---	2.04

BUL146 BUL146F

PACKAGE DIMENSIONS

CASE 221D-02
 (ISOLATED TO-220 TYPE)
 UL RECOGNIZED: FILE #E69369
 ISSUE D

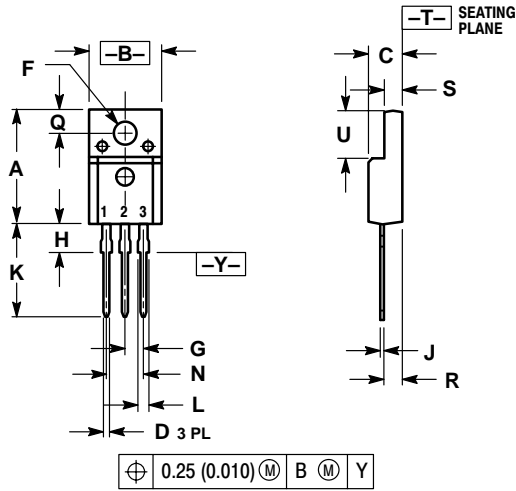

- NOTES:
1. DIMENSIONING AND TOLERANCING PER ANSI Y14.5M, 1982.
 2. CONTROLLING DIMENSION: INCH.

DIM	INCHES		MILLIMETERS	
	MIN	MAX	MIN	MAX
A	0.621	0.629	15.78	15.97
B	0.394	0.402	10.01	10.21
C	0.181	0.189	4.60	4.80
D	0.026	0.034	0.67	0.86
F	0.121	0.129	3.08	3.27
G	0.100 BSC		2.54 BSC	
H	0.123	0.129	3.13	3.27
J	0.018	0.025	0.46	0.64
K	0.500	0.562	12.70	14.27
L	0.045	0.060	1.14	1.52
N	0.200 BSC		5.08 BSC	
Q	0.126	0.134	3.21	3.40
R	0.107	0.111	2.72	2.81
S	0.096	0.104	2.44	2.64
U	0.259	0.267	6.58	6.78

- STYLE 2:
1. BASE
 2. COLLECTOR
 3. EMITTER

SWITCHMODE is a trademark of Semiconductor Components Industries, LLC.

ON Semiconductor and  are registered trademarks of Semiconductor Components Industries, LLC (SCILLC). SCILLC reserves the right to make changes without further notice to any products herein. SCILLC makes no warranty, representation or guarantee regarding the suitability of its products for any particular purpose, nor does SCILLC assume any liability arising out of the application or use of any product or circuit, and specifically disclaims any and all liability, including without limitation special, consequential or incidental damages. "Typical" parameters which may be provided in SCILLC data sheets and/or specifications can and do vary in different applications and actual performance may vary over time. All operating parameters, including "Typicals" must be validated for each customer application by customer's technical experts. SCILLC does not convey any license under its patent rights nor the rights of others. SCILLC products are not designed, intended, or authorized for use as components in systems intended for surgical implant into the body, or other applications intended to support or sustain life, or for any other application in which the failure of the SCILLC product could create a situation where personal injury or death may occur. Should Buyer purchase or use SCILLC products for any such unintended or unauthorized application, Buyer shall indemnify and hold SCILLC and its officers, employees, subsidiaries, affiliates, and distributors harmless against all claims, costs, damages, and expenses, and reasonable attorney fees arising out of, directly or indirectly, any claim of personal injury or death associated with such unintended or unauthorized use, even if such claim alleges that SCILLC was negligent regarding the design or manufacture of the part. SCILLC is an Equal Opportunity/Affirmative Action Employer.

PUBLICATION ORDERING INFORMATION

Literature Fulfillment:

Literature Distribution Center for ON Semiconductor
P.O. Box 5163, Denver, Colorado 80217 USA
Phone: 303-675-2175 or 800-344-3860 Toll Free USA/Canada
Fax: 303-675-2176 or 800-344-3867 Toll Free USA/Canada
Email: ONlit@hibbertco.com

N. American Technical Support: 800-282-9855 Toll Free USA/Canada

JAPAN: ON Semiconductor, Japan Customer Focus Center
4-32-1 Nishi-Gotanda, Shinagawa-ku, Tokyo, Japan 141-0031
Phone: 81-3-5740-2700
Email: r14525@onsemi.com

ON Semiconductor Website: <http://onsemi.com>

For additional information, please contact your local Sales Representative.