



CYPRESS

CY24206

MediaClock™ DTV, STB Clock Generator

Features

- Integrated phase-locked loop (PLL)
- Low-jitter, high-accuracy outputs
- 3.3V operation
- Available in 16-pin TSSOP Package

Benefits

- Internal PLL with up to 400-MHz internal operation
- Meets critical timing requirements in complex system designs
- Enables application compatibility

Part Number	Outputs	Input Frequency	Output Frequency Range
CY24206-1	3	27 MHz	1 copy 27-MHz reference clock output 1 copy of 81-/81.081-/74.175-/74.250-MHz (frequency selectable) 1 copy of 27-/27.027-/24.725-/24.75-MHz (frequency selectable)
CY24206-2	4	27 MHz	1 copy 27-MHz reference clock output 1 copy of 81-/81.081-/74.175-/74.250-MHz (frequency selectable) 1 copy of 27-/27.027-/24.725-/24.75-MHz (frequency selectable) 1 copy of 27-/27.027-/74.175-/74.25-MHz (frequency selectable)
CY24206-3	4	27 MHz	1 copy 27-MHz reference clock output 1 copy of 81-/81.081-/74.17582-/74.250-MHz (frequency selectable) 1 copy of 27-/27.027-/24.725-/24.75-MHz (frequency selectable) 1 copy of 27-/27.027-/74.175-/74.25-MHz (frequency selectable)
CY24206-4	4	27 MHz	1 copy 27-MHz reference clock output 1 copy of 81-/81.081-/74.17582-/74.250-MHz (frequency selectable) 1 copy of 27-/27.027-/24.725-/24.75-MHz (frequency selectable) 1 copy of 27-/27.027-/74.175-/74.25-MHz (frequency selectable)

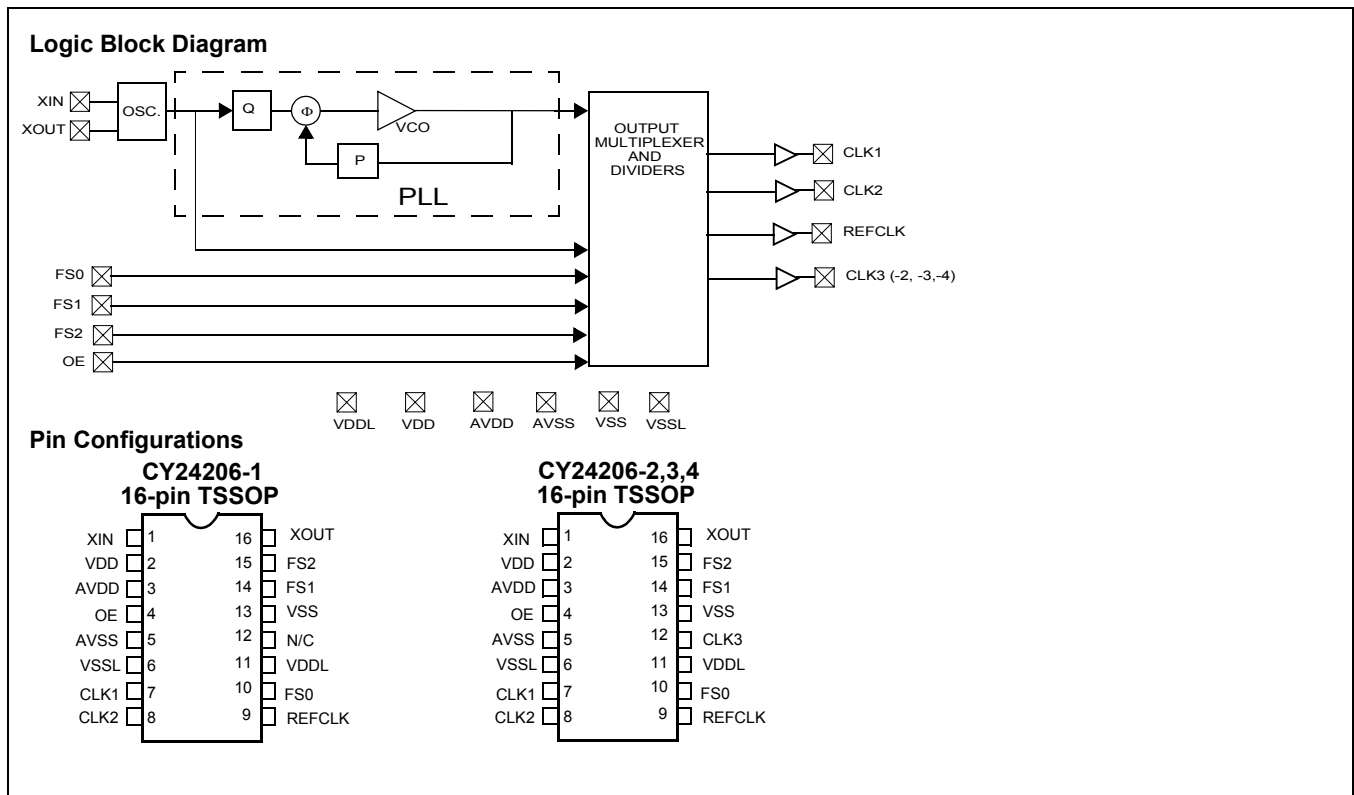

Frequency Select Options

FS2	FS1	FS0	CLK1 (-1,-2)	CLK1 (-3,-4)	CLK2	CLK3 (-2, -3,-4)	REFCLK	Units
0	0	0	81	81	27 (CLK1/3)	27 (CLK1/3)	27	MHz
0	0	1	81.081	81.081	27.027 (CLK1/3)	27.027 (CLK1/3)	27	MHz
0	1	0	74.175	74.17582	24.725 (CLK1/3)	74.17582 (CLK1)	27	MHz
0	1	1	74.250	74.25	24.75 (CLK1/3)	74.25 (CLK1)	27	MHz
1	0	0	81	81	27	27 (CLK1/3)	27	MHz
1	0	1	81.081	81.081	27	27.027 (CLK1/3)	27	MHz
1	1	0	74.175	74.1758	27	74.175 (CLK1)	27	MHz
1	1	1	74.250	74.25	27	74.25 (CLK1)	27	MHz

Pin Description

Name	Pin Number	Description
XIN	1	Reference Crystal Input.
V _{DD}	2	Voltage Supply.
AV _{DD}	3	Analog Voltage Supply.
OE	4	Output Enable, weak internal pull-up. 0 = outputs off, 1 = outputs on.
AV _{SS}	5	Analog Ground.
V _{SSL}	6	VDDL Ground.
CLK1 (-1,-2)	7	81-/81.081-/74.175-/74.250-MHz Clock Output (frequency selectable).
CLK1 (-3,-4)	7	81-/81.081-/74.17582-/74.25-MHz Clock Output (frequency selectable).
CLK2	8	27-/27.027-/24.725-/24.75-MHz Clock Output (frequency selectable).
REFCLK	9	Reference Clock Output.
FS0	10	Frequency Select 0, weak internal pull-up.
V _{DDL}	11	Voltage Supply.
N/C (-1)	12	No Connect.
CLK3 (-2,-3,-4)	12	27-/27.027-/74.175-/74.25-MHz Clock Output (frequency selectable).
VSS	13	Ground.
FS1	14	Frequency Select 1, weak internal pull-up.
FS2	15	Frequency Select 2, weak internal pull-up.
XOUT	16	Reference Crystal Output.

Absolute Maximum Conditions

Parameter	Description	Min.	Max.	Unit
V_{DD}	Supply Voltage	-0.5	7.0	V
V_{DDL}	I/O Supply Voltage		7.0	V
T_J	Junction Temperature		125	°C
	Digital Inputs	$AV_{SS} - 0.3$	$AV_{DD} + 0.3$	V
	Electrostatic Discharge	2		kV

Recommended Operating Conditions

Parameter	Description	Min.	Typ.	Max.	Unit
$V_{DD}/AV_{DDL}/V_{DDL}$	Operating Voltage	3.135	3.3	3.465	V
T_A	Ambient Temperature	0		70	°C
C_{LOAD}	Max. Load Capacitance			15	pF
f_{REF}	Reference Frequency		27		MHz

DC Electrical Specifications

Parameter ^[1]	Name	Description	Min.	Typ.	Max.	Unit
I_{OH}	Output High Current	$V_{OH} = V_{DD} - 0.5, V_{DD}/V_{DDL} = 3.3V$	12	24		mA
I_{OL}	Output Low Current	$V_{OL} = 0.5, V_{DD}/V_{DDL} = 3.3V$	12	24		mA
I_{IH}	Input High Current	$V_{IH} = V_{DD}$	-	5	10	μA
I_{IL}	Input Low Current	$V_{IL} = 0V$	-	-	50	μA
V_{IH}	Input High Voltage	CMOS levels, 70% of V_{DD}	0.7			VDD
V_{IL}	Input Low Voltage	CMOS levels, 30% of V_{DD}			0.3	VDD
I_{VDD}	Supply Current	AV_{DD}/V_{DD} Current			25	mA
I_{VDDL}	Supply Current	V_{DDL} Current			20	mA
R_{UP}	Pull-up resistor on Inputs	$V_{DD} = 3.14$ to $3.47V$, measured $V_{IN} = 0V$		100	150	kΩ

AC Electrical Specifications

Parameter ^[1]	Name	Description	Min.	Typ.	Max.	Unit
DC	Output Duty Cycle	Duty Cycle is defined in <i>Figure 1</i> ; t_1/t_2 , 50% of V_{DD}	45	50	55	%
ER	Rising Edge Rate	Output Clock Edge Rate, Measured from 20% to 80% of V_{DD} , $C_{LOAD} = 15$ pF. See <i>Figure 2</i> .	0.8	1.4		V/ns
EF	Falling Edge Rate	Output Clock Edge Rate, Measured from 80% to 20% of V_{DD} , $C_{LOAD} = 15$ pF. See <i>Figure 2</i> .	0.8	1.4		V/ns
t_9	Clock Jitter	CLK1, CLK2 Peak-Peak period jitter		200		ps
t_{10}	PLL Lock Time				3	ms

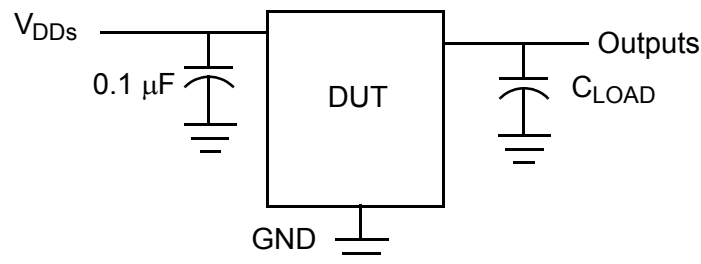
Test and Measurement Set-up

Note:

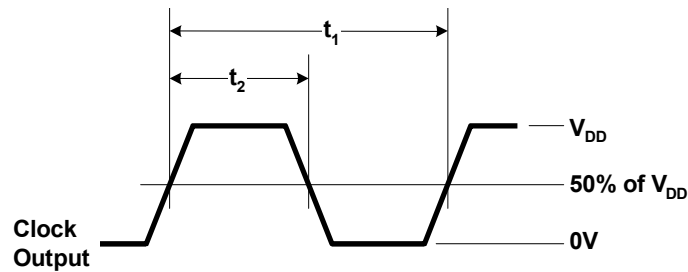
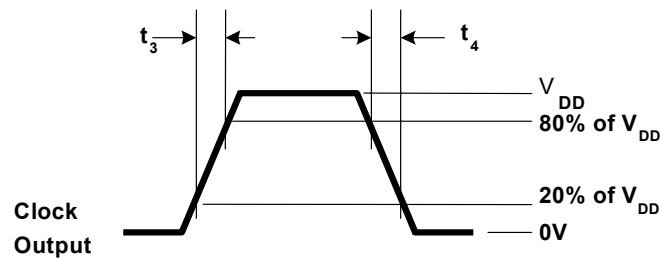
1. Not 100% tested.

Voltage and Timing Definitions

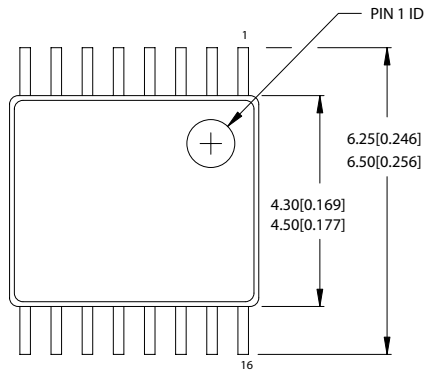
Figure 1. Duty Cycle Definitions

Figure 2. $ER = (0.6 \times V_{DD}) / t_3$, $EF = (0.6 \times V_{DD}) / t_4$
Ordering Information

Ordering Code	Package Name	Package Type	Operating Range	Operating Voltage
CY24206ZC-2	Z16	16-Pin TSSOP	Commercial	3.3V
CY24206ZC-2T	Z16	16-Pin TSSOP – Tape and Reel	Commercial	3.3V
CY24206ZC-3	Z16	16-Pin TSSOP	Commercial	3.3V
CY24206ZC-3T	Z16	16-Pin TSSOP – Tape and Reel	Commercial	3.3V
CY24206ZC-4	Z16	16-Pin TSSOP	Commercial	3.3V
CY24206ZC-4T	Z16	16-Pin TSSOP – Tape and Reel	Commercial	3.3V
Lead Free				
CY24206ZXC-4	Z16	16-Pin TSSOP	Commercial	3.3V
CY24206ZXC-4T	Z16	16-Pin TSSOP – Tape and Reel	Commercial	3.3V

Package Drawing and Dimensions
16-lead TSSOP 4.40 MM Body Z16.173

DIMENSIONS IN MM[INCHES] MIN.
MAX.

REFERENCE JEDEC MO-153

PACKAGE WEIGHT 0.05 gms

PART #	
Z16.173	STANDARD PKG.
ZZ16.173	LEAD FREE PKG.

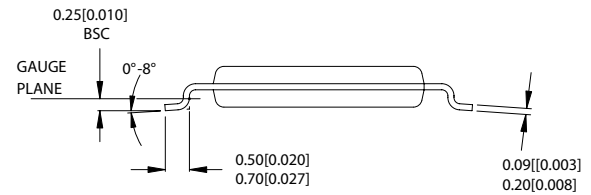
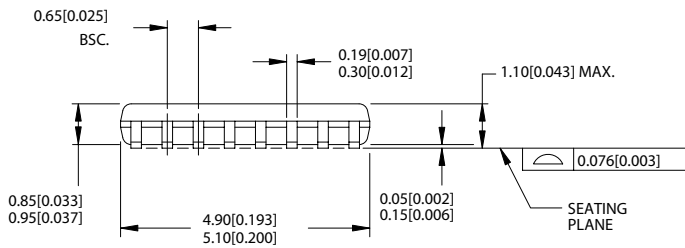

51-85091-*A

MediaClock is a trademark of Cypress Semiconductor Corporation. All product and company names mentioned in this document may be the trademarks of their respective holders.

Document History Page

Document Title: CY24206 MediaClock™ DTV, STB Clock Generator				
Document Number: 38-07451				
REV.	ECN NO.	Issue Date	Orig. of Change	Description of Change
**	120901	12/10/02	CKN	New data sheet
*A	123046	03/03/03	CKN	Added -4 to data sheet
*B	270029	See ECN	RGL	Removed Preliminary Added Lead-free devices for -4