

### General Description

The AAT3221 and AAT3222 PowerLinear™ NanoPower Low Dropout Linear Regulators are ideal for portable applications where extended battery life is critical. This device features extremely low quiescent current which is typically 1.1µA. Dropout voltage is also very low, typically less than 200mV at the maximum output current of 150mA. The AAT3221/2 has an Enable pin feature, which when asserted will enter the LDO regulator into a shutdown mode removing power from its load and offering extended power conservation capabilities for portable battery powered applications.

The AAT3221/2 has output short circuit and over current protection. In addition, the device also has an over temperature protection circuit, which will shutdown the LDO regulator during extended over-current events. It is available with active high or active low enable input.

The AAT3221 and AAT3222 are available in space saving 5-pin SOT23 packages. The AAT3221 is also available in the 8-pin SC70JW package. The device is rated over a -40°C to 85°C temperature range. Since only a small, 1µF ceramic output capacitor is recommended, often the only space used is that occupied by the AAT3221/2 itself. The AAT3221/2 is truly a compact and cost effective voltage conversion solution.

The AAT3221/2 is similar to the AAT3220 with the exception that it offers further power savings with its enable pin.

### Features

- 1.1 µA Quiescent Current
- Low Dropout: 200 mV (typical)
- Guaranteed 150 mA Output
- High accuracy: ±2%
- Current limit protection
- Over-Temperature protection
- Extremely Low power shutdown mode
- Low Temperature Coefficient
- Factory programmed output voltages
  - 1.8V to 3.5V
- Stable operation with virtually any output capacitor type
- Active high or low Enable pin
- 5-pin SOT23 or 8-pin SC70JW packages
- 4kV ESD

### Applications

- Cellular Phones
- Notebook Computers
- Portable Communication Devices
- Handheld Electronics
- Remote Controls
- Digital Cameras
- PDAs

### Typical Application

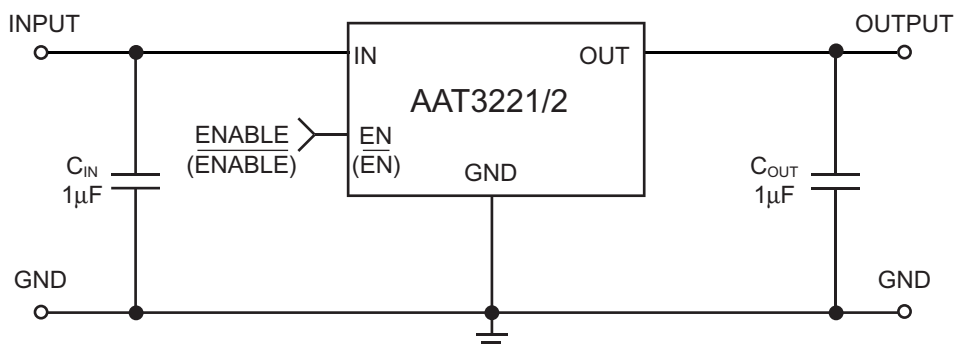

### Pin Descriptions

Pin #		AAT3222	Symbol	Function
AAT3221				
SOT23-5	SC70JW-8			
1	2	2	IN	Input pin
2	5, 6, 7, 8	1	GND	Ground connection pin
3	4	5	EN ( $\overline{\text{EN}}$ )	Enable Input. Logic compatible enable with active high or active low option available; see Ordering Information and Applications Information for details.
4	3	4	NC	Not Connected
5	1	3	OUT	Output pin - should be decoupled with 1 $\mu$ F or greater capacitor

### Pin Configuration

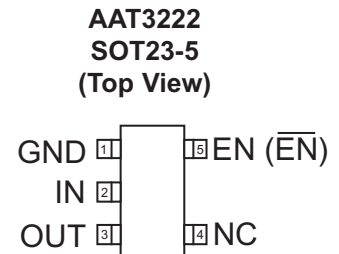
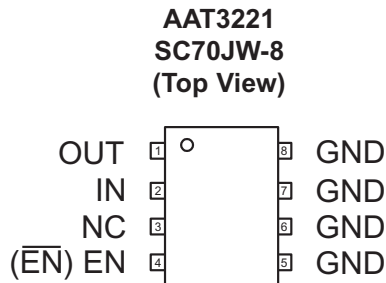
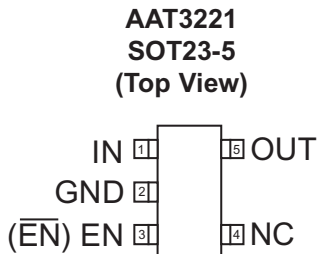

### Absolute Maximum Ratings (T<sub>A</sub>=25°C unless otherwise noted)

Symbol	Description	Value	Units
V <sub>IN</sub>	Input Voltage	-0.3 to 6	V
V <sub>EN</sub>	EN ( $\overline{\text{EN}}$ ) to GND Voltage	-0.3 to 6	V
V <sub>ENIN(MAX)</sub>	Maximum EN ( $\overline{\text{EN}}$ ) to Input Voltage	0.3	V
I <sub>OUT</sub>	Maximum DC Output Current	P <sub>D</sub> /(V <sub>IN</sub> -V <sub>O</sub> )	mA
T <sub>J</sub>	Operating Junction Temperature Range	-40 to 150	°C
T <sub>LEAD</sub>	Maximum Soldering Temperature (at leads, 10 sec)	300	°C

Note: Stresses above those listed in Absolute Maximum Ratings may cause permanent damage to the device. Functional operation at conditions other than the operating conditions specified is not implied. Only one Absolute Maximum rating should be applied at any one time.

### Thermal Information

Symbol	Description	Rating	Units
Θ <sub>JA</sub>	Thermal Resistance (SOT23-5 or SC70JW-8) <sup>1</sup>	150	°C/W
P <sub>D</sub>	Power Dissipation (SOT23-5 or SC70JW-8) <sup>1</sup>	667	mW

Note 1: Mounted on a demo board.

### Recommended Operating Conditions

Symbol	Description	Rating	Units
V <sub>IN</sub>	Input Voltage	(V <sub>OUT</sub> +0.34) to 5.5	V
T	Ambient Temperature Range	-40 to +85	°C

### Electrical Characteristics ( $V_{IN}=V_{OUT(NOM)}+1V$ , $I_{OUT}=1mA$ , $C_{OUT}=1\mu F$ , $T_A=25^\circ C$ unless otherwise noted)

Symbol	Description	Conditions	Min	Typ	Max	Units
$V_{OUT}$	DC Output Voltage Tolerance		-2.0		2.0	%
		$V_{OUT}=2.8V$	-1.4		1.4	
$I_{OUT}$	Output Current	$V_{OUT} > 1.2 V$	150			mA
$I_{SC}$	Short Circuit Current	$V_{OUT} < 0.4 V$		350		mA
$I_Q$	Ground Current	$V_{IN} = 5 V$ , no load		1.1	2.5	$\mu A$
$I_{SD}$	Shutdown Current	EN = inactive		20		nA
$\Delta V_{OUT}/V_{OUT}$	Line Regulation	$V_{IN} = 4.0-5.5 V$		0.15	0.4	%/V
$\Delta V_{OUT}/V_{OUT}$	Load Regulation	$I_L=1$ to 100mA	$V_{OUT} = 1.8$	1.0	1.65	%
			$V_{OUT} = 2.0$	0.9	1.58	
			$V_{OUT} = 2.3$	0.8	1.45	
			$V_{OUT} = 2.4$	0.8	1.40	
			$V_{OUT} = 2.5$	0.8	1.35	
			$V_{OUT} = 2.7$	0.7	1.25	
			$V_{OUT} = 2.8$	0.7	1.20	
			$V_{OUT} = 2.85$	0.7	1.20	
			$V_{OUT} = 3.0$	0.6	1.15	
			$V_{OUT} = 3.3$	0.5	1.00	
			$V_{OUT} = 3.5$	0.5	1.00	
$V_{DO}$	Dropout Voltage <sup>1</sup>	$I_{OUT} = 100mA$	$V_{OUT} = 1.8$	290	340	mV
			$V_{OUT} = 2.0$	265	315	
			$V_{OUT} = 2.3$	230	275	
			$V_{OUT} = 2.4$	220	265	
			$V_{OUT} = 2.5$	210	255	
			$V_{OUT} = 2.7$	200	240	
			$V_{OUT} = 2.8$	190	235	
			$V_{OUT} = 2.85$	190	230	
			$V_{OUT} = 3.0$	190	225	
			$V_{OUT} = 3.3$	180	220	
			$V_{OUT} = 3.5$	180	220	
$V_{EN(L)}$	EN Input Low Voltage				0.8	V
$V_{EN(H)}$	EN Input High Voltage	$V_{IN} = 2.7 V$ to 3.6 V	2.0			V
		$V_{IN} = 5 V$	2.4			V
$I_{EN(SINK)}$	EN Input leakage	$V_{ON} = 5.5 V$		0.01	1	$\mu A$
PSRR	Power Supply Rejection Ratio	100 Hz		50		dB
$T_{SD}$	Over Temp Shutdown Threshold			140		$^\circ C$
$T_{HYS}$	Over Temp Shutdown Hysteresis			20		$^\circ C$
$e_N$	Output Noise			350		$\mu V_{RMS}$
$T_C$	Output Voltage Temp. Coefficient			80		PPM/ $^\circ C$

Note 1:  $V_{DO}$  is defined as  $V_{IN} - V_{OUT}$  when  $V_{OUT}$  is 98% of nominal.

### Typical Characteristics

(Unless otherwise noted,  $V_{IN} = V_{OUT} + 1V$ ,  $T_A = 25\text{ C}$ ,  $C_{OUT} = 5.6\text{ F}$  ceramic,  $I_{OUT} = 100\text{ mA}$ )

**Output Voltage vs. Output Current**

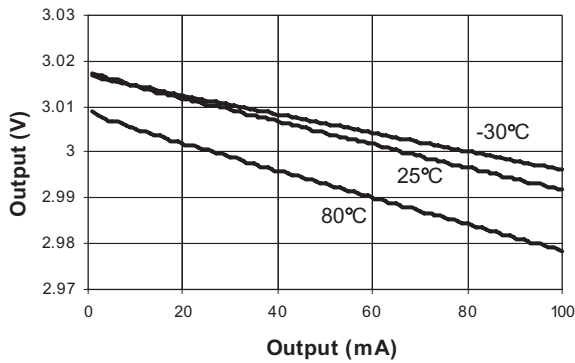

**Output Voltage v. Input Voltage**

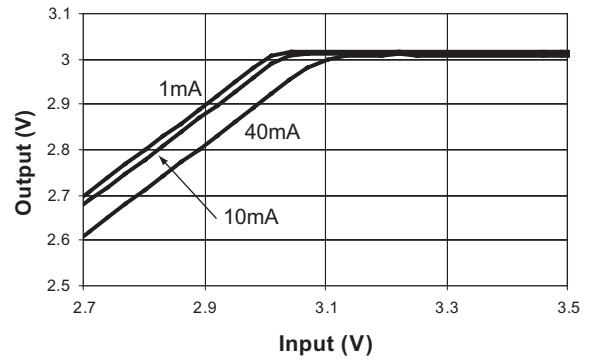

**Output Voltage vs. Input Voltage**

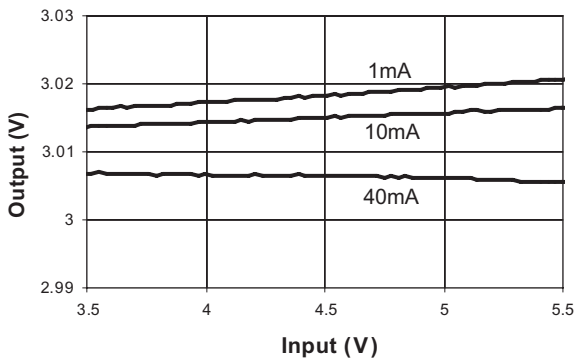

**Drop-out Voltage vs. Output Current**

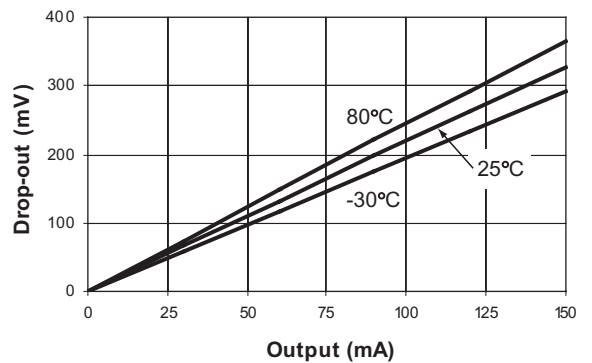

**Supply Current vs. Input Voltage**

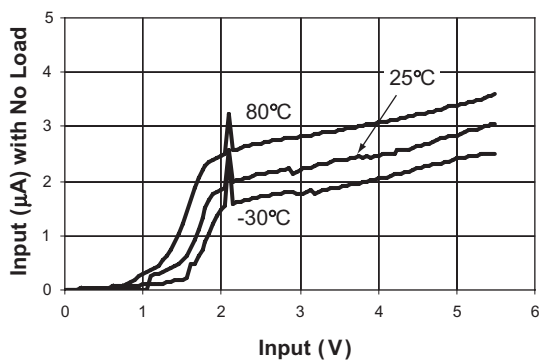

**PSRR with 10mA Load**

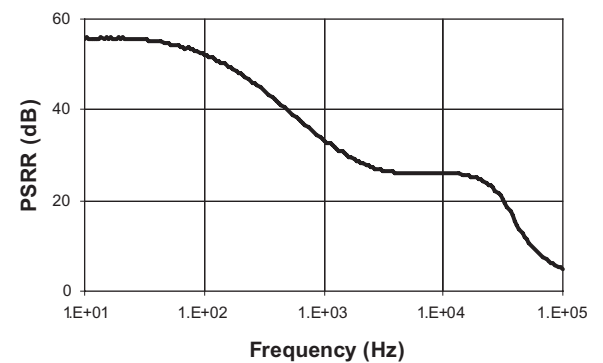

(Unless otherwise noted,  $V_{IN} = V_{OUT} + 1V$ ,  $T_A = 25^\circ C$ ,  $C_{OUT} = 5.6\mu F$  ceramic,  $I_{OUT} = 100mA$ )

**Noise Spectrum**

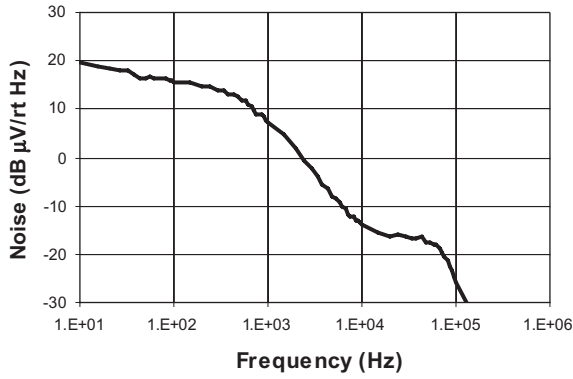

**Line Response with 1mA Load**

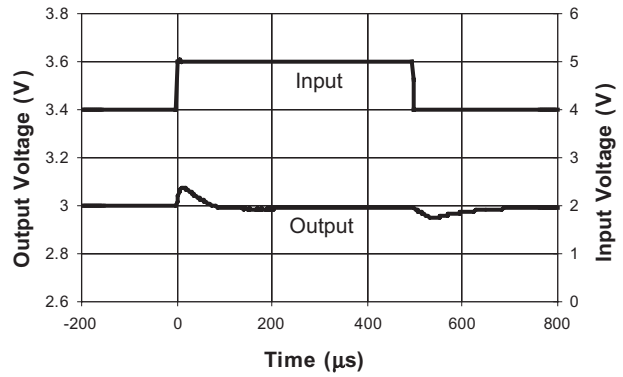

**Line Response with 10mA Load**

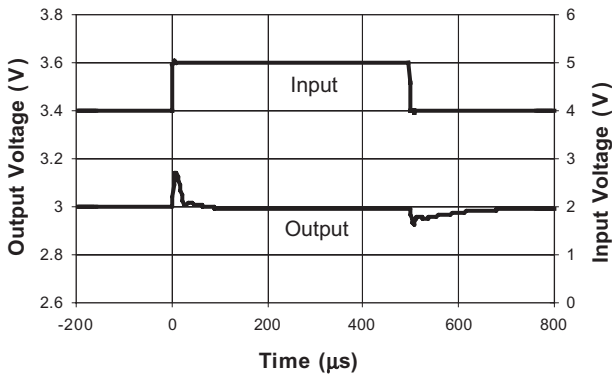

**Line Response with 100mA Load**

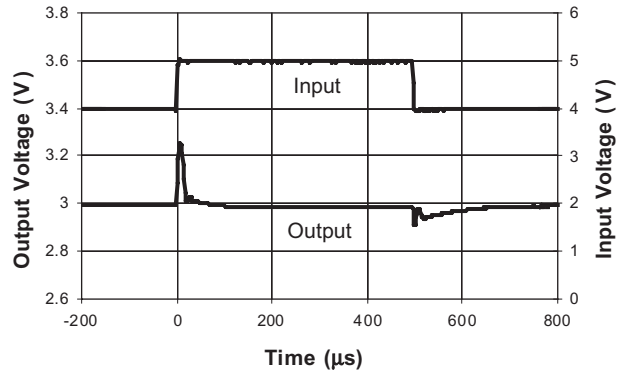

**Load Transient - 1 mA / 40 mA**

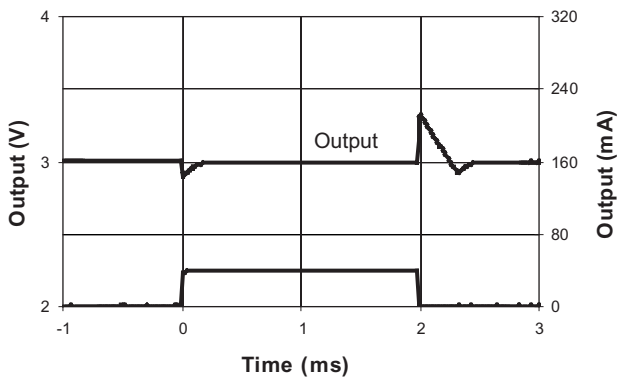

**Load Transient - 1 mA / 80 mA**

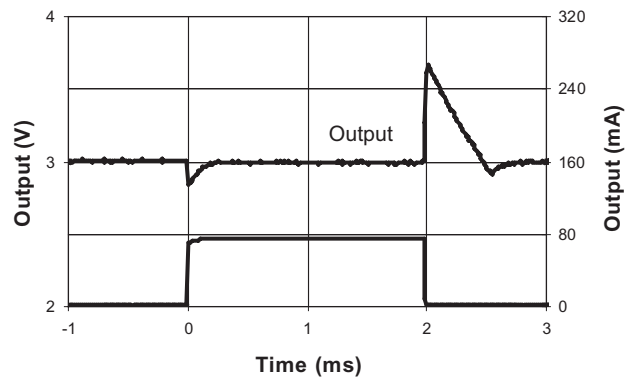

(Unless otherwise noted,  $V_{IN} = V_{OUT} + 1V$ ,  $T_A = 25^\circ C$ ,  $C_{OUT} = 5.6\mu F$  ceramic,  $I_{OUT} = 100mA$ )

**Power Up with 1mA Load**

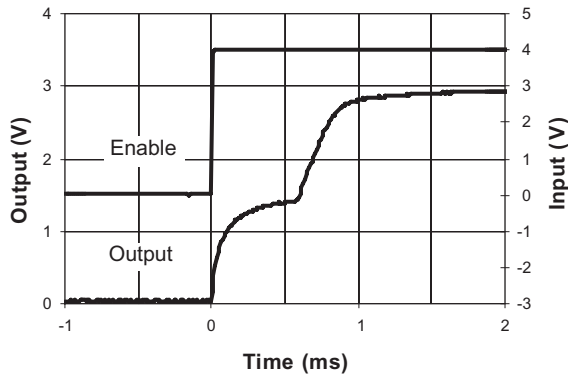

**Turn On with 1mA Load**

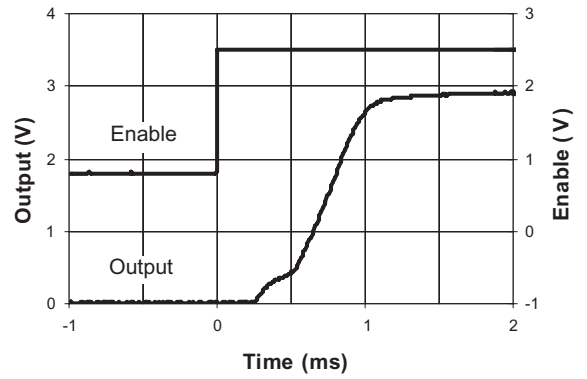

**Power Up with 10mA Load**

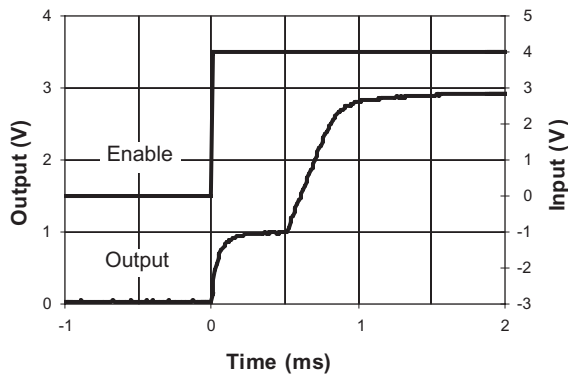

**Turn On with 10mA Load**

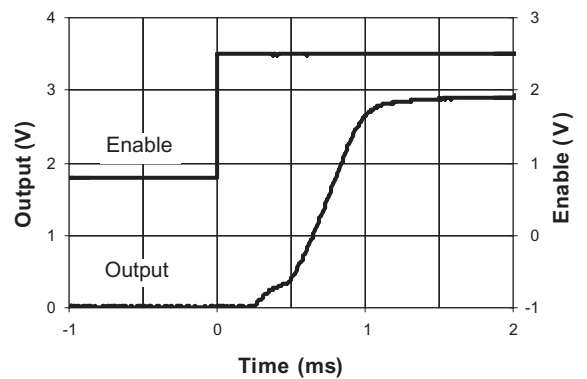

**Power Up with 100mA Load**

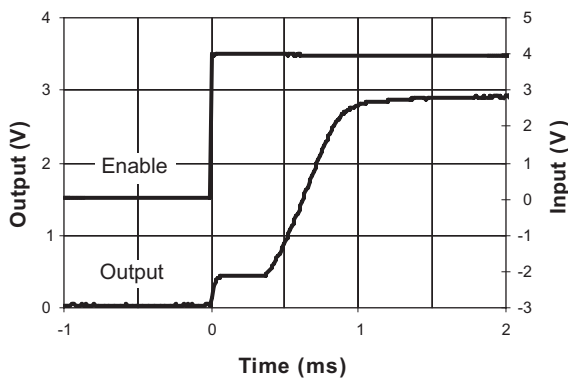

**Turn On with 100mA Load**

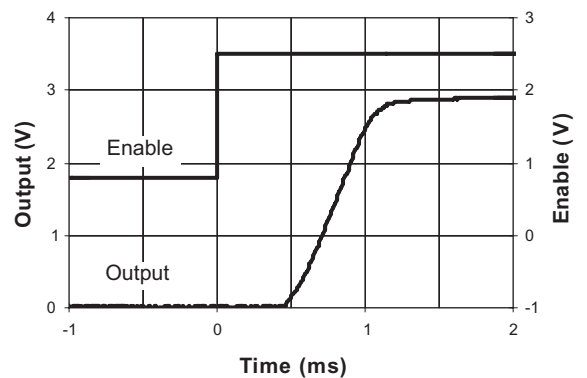

## Functional Block Diagram

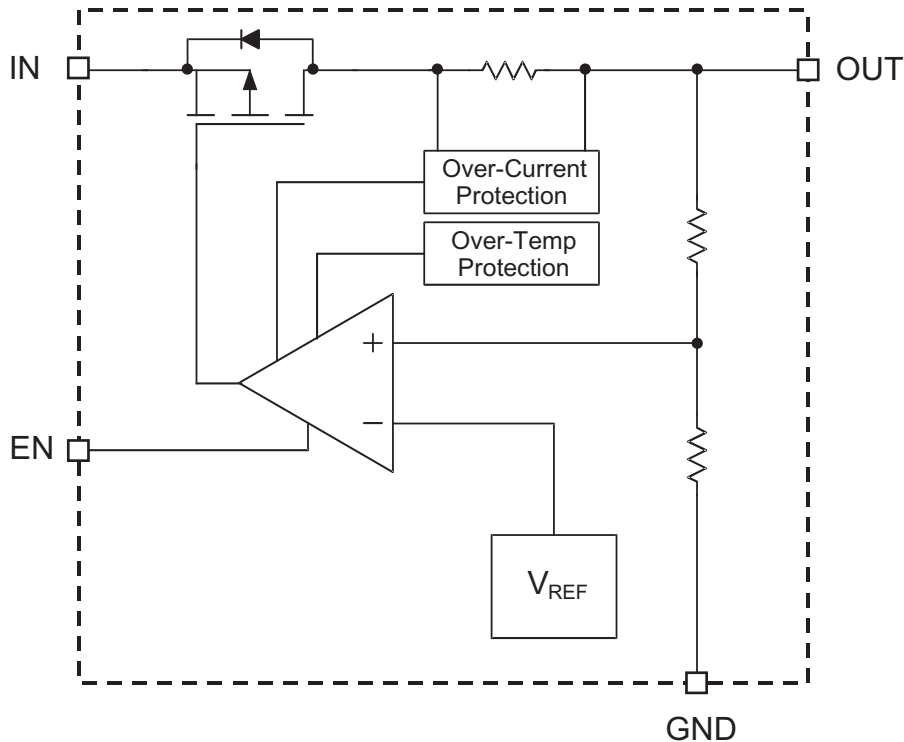

## Functional Description

The AAT3221 and AAT3222 are intended for LDO regulator applications where output current load requirements range from No Load to 150mA. The advanced circuit design of the AAT3221/2 has been optimized for very low quiescent or ground current consumption making it ideal for use in power management systems for small battery operated devices. The typical quiescent current level is just 1.1 $\mu$ A. The AAT3221/2 also contains an enable circuit, which has been provided to shutdown the LDO regulator for additional power conservation in portable products. In the shutdown state the LDO draws less than 1 $\mu$ A from input supply.

The LDO also demonstrates excellent power supply ripple rejection (PSRR), and load and line transient response characteristics. The AAT3221/2 is a

truly high performance LDO regulator especially well suited for circuit applications which are sensitive to load circuit power consumption and extended battery life.

The LDO regulator output has been specifically optimized to function with low cost, low ESR ceramic capacitors. However, the design will allow for operation with a wide range of capacitor types.

The AAT3221/2 has complete short circuit and thermal protection. The integral combination of these two internal protection circuits give the AAT3221/2 a comprehensive safety system to guard against extreme adverse operating conditions. Device power dissipation is limited to the package type and thermal dissipation properties. Refer to the thermal considerations section for details on device operation at maximum output load levels.



## Applications Information

To assure the maximum possible performance is obtained from the AAT3221/2, please refer to the following application recommendations.

### **Input Capacitor**

Typically a 1 $\mu$ F or larger capacitor is recommended for  $C_{IN}$  in most applications. A  $C_{IN}$  capacitor is not required for basic LDO regulator operation. However, if the AAT3221/2 is physically located any distance more than a centimeter or two from the input power source, a  $C_{IN}$  capacitor will be needed for stable operation.  $C_{IN}$  should be located as close to the device  $V_{IN}$  pin as practically possible.  $C_{IN}$  values greater than 1 $\mu$ F will offer superior input line transient response and will assist in maximizing the power supply ripple rejection.

Ceramic, tantalum or aluminum electrolytic capacitors may be selected for  $C_{IN}$  as there is no specific capacitor ESR requirement. For 150mA LDO regulator output operation, ceramic capacitors are recommended for  $C_{IN}$  due to their inherent capability over tantalum capacitors to withstand input current surges from low impedance sources such as batteries in portable devices.

### **Output Capacitor**

For proper load voltage regulation and operational stability, a capacitor is required between pins  $V_{OUT}$  and GND. The  $C_{OUT}$  capacitor connection to the LDO regulator ground pin should be made as direct as practically possible for maximum device performance. The AAT3221/2 has been specifically designed to function with very low ESR ceramic capacitors. Although the device is intended to operate with these low ESR capacitors, it is stable over a very wide range of capacitor ESR, thus it will also work with some higher ESR tantalum or aluminum electrolytic capacitors. However, for best performance, ceramic capacitors are recommended.

The value of  $C_{OUT}$  typically ranges from 0.47 $\mu$ F to 10 $\mu$ F, however 1 $\mu$ F is sufficient for most operating conditions.

If large output current steps are required by an application, then an increased value for  $C_{OUT}$  should be considered. The amount of capacitance needed can be calculated from the step size of the change in output load current expected and the voltage excursion that the load can tolerate.

The total output capacitance required can be calculated using the following formula:

$$C_{OUT} = \frac{\Delta I}{\Delta V} \times 15\mu F$$

Where:

$\Delta I$  = maximum step in output current

$\Delta V$  = maximum excursion in voltage that the load can tolerate

Note that use of this equation results in capacitor values approximately two to four times the typical value needed for an AAT3221/2 at room temperature. The increased capacitor value is recommended if tight output tolerances must be maintained over extreme operating conditions and maximum operational temperature excursions. If tantalum or aluminum electrolytic capacitors are used, the capacitor value should be increased to compensate for the substantial ESR inherent to these capacitor types.

### **Capacitor Characteristics**

Ceramic composition capacitors are highly recommended over all other types of capacitors for use with the AAT3221/2. Ceramic capacitors offer many advantages over their tantalum and aluminum electrolytic counterparts. A ceramic capacitor typically has very low ESR, is lower cost, has a smaller PCB footprint and is non-polarized. Line and load transient response of the LDO regulator is improved by using low ESR ceramic capacitors. Since ceramic capacitors are non-polarized, they are less prone to damage if connected incorrectly.

**Equivalent Series Resistance (ESR):** ESR is a very important characteristic to consider when selecting a capacitor. ESR is the internal series resistance associated with a capacitor, which includes lead resistance, internal connections, capacitor size and area, material composition and ambient temperature. Typically capacitor ESR is measured in milliohms for ceramic capacitors and can range to more than several ohms for tantalum or aluminum electrolytic capacitors.

**Ceramic Capacitor Materials:** Ceramic capacitors less than 0.1 $\mu$ F are typically made from NPO or COG materials. NPO and COG materials are typically tight tolerance and very stable over temperature. Larger capacitor values are typically composed of X7R, X5R, Z5U and Y5V dielectric materials.

Large ceramic capacitors, typically greater than 2.2µF are often available in the low cost Y5V and Z5U dielectrics. These two material types are not recommended for use with LDO regulators since the capacitor tolerance can vary more than ±50% over the operating temperature range of the device. A 2.2µF Y5V capacitor could be reduced to 1µF over the full operating temperature range. This can cause problems for circuit operation and stability. X7R and X5R dielectrics are much more desirable. The temperature tolerance of X7R dielectric is better than ±15%.

Capacitor area is another contributor to ESR. Capacitors, which are physically large in size will have a lower ESR when compared to a smaller sized capacitor of equivalent material and capacitance value. These larger devices can also improve circuit transient response when compared to an equal value capacitor in a smaller package size.

Consult capacitor vendor data sheets carefully when selecting capacitors for use with LDO regulators.

### Enable Function

The AAT3221/2 features an LDO regulator enable / disable function. This pin (EN) is compatible with CMOS logic. Active high or active low options are available (see Ordering Information). For a logic high signal, the EN control level must be greater than 2.4 volts. A logic low signal is asserted when the voltage on the EN pin falls below 0.6 volts. For example, the active high version 3221/2 will turn on when a logic high is applied to the EN pin. If the enable function is not needed in a specific application, it may be tied to the respective voltage level to keep the LDO regulator in a continuously on state; e.g. the active high version 3221/2 will tie  $V_{IN}$  to EN to remain on.

### Short Circuit Protection and Thermal Protection

The AAT3221/2 is protected by both current limit and over temperature protection circuitry. The internal short circuit current limit is designed to activate when the output load demand exceeds the maximum rated output. If a short circuit condition were to continually draw more than the current limit threshold, the LDO regulator's output voltage will drop to a level necessary to supply the current demanded by the load. Under short circuit or other over current operating conditions, the output voltage will drop and the AAT3221/2's die temperature will increase rapidly. Once the regulator's power

dissipation capacity has been exceeded and the internal die temperature reaches approximately 140°C the system thermal protection circuit will become active. The internal thermal protection circuit will actively turn off the LDO regulator output pass device to prevent the possibility of over temperature damage. The LDO regulator output will remain in a shutdown state until the internal die temperature falls back below the 140°C trip point.

The interaction between the short circuit and thermal protection systems allow the LDO regulator to withstand indefinite short circuit conditions without sustaining permanent damage.

### No-Load Stability

The AAT3221/2 is designed to maintain output voltage regulation and stability under operational no-load conditions. This is an important characteristic for applications where the output current may drop to zero. An output capacitor is required for stability under no load operating conditions. Refer to the output capacitor considerations section for recommended typical output capacitor values.

### Thermal Considerations and High Output Current Applications

The AAT3221/2 is designed to deliver a continuous output load current of 150mA under normal operating conditions. The limiting characteristic for the maximum output load safe operating area is essentially package power dissipation and the internal pre-set thermal limit of the device. In order to obtain high operating currents, careful device layout and circuit operating conditions need to be taken into account. The following discussions will assume the LDO regulator is mounted on a printed circuit board utilizing the minimum recommended footprint and the printed circuit board is 0.062inch thick FR4 material with one ounce copper.

At any given ambient temperature ( $T_A$ ) the maximum package power dissipation can be determined by the following equation:

$$P_{D(MAX)} = [T_{J(MAX)} - T_A] / \Theta_{JA}$$

Constants for the AAT3221/2 are  $T_{J(MAX)}$ , the maximum junction temperature for the device which is 125°C and  $\Theta_{JA} = 150^\circ\text{C/W}$ , the package thermal resistance. Typically, maximum conditions are calculated at the maximum operating temperature where  $T_A = 85^\circ\text{C}$ , under normal ambient conditions

$T_A = 25^\circ\text{C}$ . Given  $T_A = 85^\circ$ , the maximum package power dissipation is 267mW. At  $T_A = 25^\circ\text{C}$ , the maximum package power dissipation is 667mW.

The maximum continuous output current for the AAT3221/2 is a function of the package power dissipation and the input to output voltage drop across the LDO regulator. Refer to the following simple equation:

$$I_{\text{OUT(MAX)}} < P_{\text{D(MAX)}} / (V_{\text{IN}} - V_{\text{OUT}})$$

For example, if  $V_{\text{IN}} = 5\text{V}$ ,  $V_{\text{OUT}} = 2.5\text{V}$  and  $T_A = 25^\circ$ ,  $I_{\text{OUT(MAX)}} < 267\text{mA}$ . The output short circuit protection threshold is set between 150mA and 300mA. If the output load current were to exceed 267mA or if the ambient temperature were to increase, the internal die temperature will increase. If the condition remained constant and the short circuit protection did not activate, there would be a potential damage hazard to LDO regulator since the thermal protection circuit will only activate after a short circuit event occurs on the LDO regulator output.

To figure what the maximum input voltage would be for a given load current refer to the following equation. This calculation accounts for the total power dissipation of the LDO Regulator, including that caused by ground current.

$$P_{\text{D(MAX)}} = (V_{\text{IN}} - V_{\text{OUT}})I_{\text{OUT}} + (V_{\text{IN}} \times I_{\text{GND}})$$

This formula can be solved for  $V_{\text{IN}}$  to determine the maximum input voltage.

$$V_{\text{IN(MAX)}} = (P_{\text{D(MAX)}} + (V_{\text{OUT}} \times I_{\text{OUT}})) / (I_{\text{OUT}} + I_{\text{GND}})$$

The following is an example for an AAT3221/2 set for a 2.5 volt output:

From the discussion above,  $P_{\text{D(MAX)}}$  was determined to equal 667mW at  $T_A = 25^\circ\text{C}$ .

$$\begin{aligned} V_{\text{OUT}} &= 2.5 \text{ volts} \\ I_{\text{OUT}} &= 150\text{mA} \\ I_{\text{GND}} &= 1.1\mu\text{A} \end{aligned}$$

$$V_{\text{IN(MAX)}} = (667\text{mW} + (2.5\text{V} \times 150\text{mA})) / (150\text{mA} + 1.1\mu\text{A})$$

$$V_{\text{IN(MAX)}} = 6.95\text{V}$$

Thus, the AAT3221/2 can sustain a constant 2.5V output at a 150mA load current as long as  $V_{\text{IN}}$  is  $\leq 6.95\text{V}$  at an ambient temperature of  $25^\circ\text{C}$ . 5.5V is the maximum input operating voltage for the

AAT3221/2, thus at  $25^\circ\text{C}$ , the device would not have any thermal concerns or operational  $V_{\text{IN(MAX)}}$  limits.

This situation can be different at  $85^\circ\text{C}$ . The following is an example for an AAT3221/2 set for a 2.5 volt output at  $85^\circ\text{C}$ :

From the discussion above,  $P_{\text{D(MAX)}}$  was determined to equal 267mW at  $T_A = 85^\circ\text{C}$ .

$$\begin{aligned} V_{\text{OUT}} &= 2.5 \text{ volts} \\ I_{\text{OUT}} &= 150\text{mA} \\ I_{\text{GND}} &= 1.1\mu\text{A} \end{aligned}$$

$$V_{\text{IN(MAX)}} = (267\text{mW} + (2.5\text{V} \times 150\text{mA})) / (150\text{mA} + 1.1\mu\text{A})$$

$$V_{\text{IN(MAX)}} = 4.28\text{V}$$

Higher input to output voltage differentials can be obtained with the AAT3221/2, while maintaining device functions in the thermal safe operating area. To accomplish this, the device thermal resistance must be reduced by increasing the heat sink area or by operating the LDO regulator in a duty cycled mode.

For example, an application requires  $V_{\text{IN}} = 5.0\text{V}$  while  $V_{\text{OUT}} = 2.5\text{V}$  at a 150mA load and  $T_A = 85^\circ\text{C}$ .  $V_{\text{IN}}$  is greater than 4.28V, which is the maximum safe continuous input level for  $V_{\text{OUT}} = 2.5\text{V}$  at 150mA for  $T_A = 85^\circ\text{C}$ . To maintain this high input voltage and output current level, the LDO regulator must be operated in a duty cycled mode. Refer to the following calculation for duty cycle operation:

$P_{\text{D(MAX)}}$  is assumed to be 267mW

$$\begin{aligned} I_{\text{GND}} &= 1.1\mu\text{A} \\ I_{\text{OUT}} &= 150\text{mA} \\ V_{\text{IN}} &= 5.0 \text{ volts} \\ V_{\text{OUT}} &= 2.5 \text{ volts} \end{aligned}$$

$$\%DC = 100(P_{\text{D(MAX)}} / ((V_{\text{IN}} - V_{\text{OUT}})I_{\text{OUT}} + (V_{\text{IN}} \times I_{\text{GND}})))$$

$$\%DC = 100(267\text{mW} / ((5.0\text{V} - 2.5\text{V})150\text{mA} + (5.0\text{V} \times 1.1\mu\text{A})))$$

$$\%DC = 71.2\%$$

For a 150mA output current and a 2.5 volt drop across the AAT3221/2 at an ambient temperature of  $85^\circ\text{C}$ , the maximum on time duty cycle for the device would be 71.2%.

The following family of curves shows the safe operating area for duty cycled operation from ambient room temperature to the maximum operating level.

**Device Duty Cycle vs.  $V_{DROP}$**   
 **$V_{OUT} = 2.5V @ 25 \text{ degrees C}$**

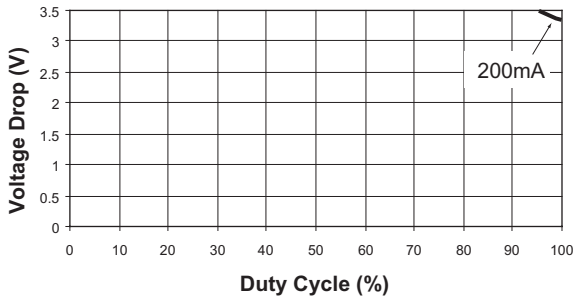

**Device Duty Cycle vs.  $V_{DROP}$**   
 **$V_{OUT} = 2.5V @ 50 \text{ degrees C}$**

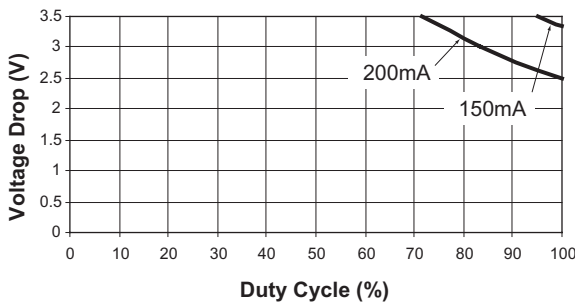

**Device Duty Cycle vs.  $V_{DROP}$**   
 **$V_{OUT} = 2.5V @ 85 \text{ degrees C}$**

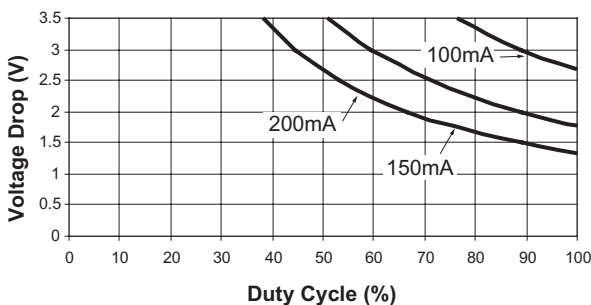

### High Peak Output Current Applications

Some applications require the LDO regulator to operate at continuous nominal levels with short duration high current peaks. The duty cycles for both output current levels must be taken into account. To do so, one would first need to calculate the power dissipation at the nominal continuous level, then factor in the addition power dissipation due to the short duration high current peaks.

For example, a 2.5V system using a AAT3221/2IGV-2.5-T1 operates at a continuous 100mA load current level and has short 150mA current peaks. The current peak occurs for 378 $\mu$ s out of a 4.61ms period. It will be assumed the input voltage is 5.0V.

First, the current duty cycle percentage must be calculated:

$$\% \text{ Peak Duty Cycle} = X/100 = 378\mu\text{s}/4.61\text{ms}$$

$$\% \text{ Peak Duty Cycle} = 8.2\%$$

The LDO Regulator will be under the 100mA load for 91.8% of the 4.61ms period and have 150mA peaks occurring for 8.2% of the time. Next, the continuous nominal power dissipation for the 100mA load should be determined then multiplied by the duty cycle to conclude the actual power dissipation over time.

$$P_{D(MAX)} = (V_{IN} - V_{OUT})I_{OUT} + (V_{IN} \times I_{GND})$$

$$P_{D(100mA)} = (5.0V - 2.5V)100mA + (5.0V \times 1.1mA)$$

$$P_{D(100mA)} = 250mW$$

$$P_{D(91.8\%D/C)} = \%DC \times P_{D(100mA)}$$

$$P_{D(91.8\%D/C)} = 0.918 \times 250mW$$

$$P_{D(91.8\%D/C)} = 229.5mW$$

The power dissipation for a 100mA load occurring for 91.8% of the duty cycle will be 229.5mW. Now the power dissipation for the remaining 8.2% of the duty cycle at the 150mA load can be calculated:

$$P_{D(MAX)} = (V_{IN} - V_{OUT})I_{OUT} + (V_{IN} \times I_{GND})$$
$$P_{D(150mA)} = (5.0V - 2.5V)150mA + (5.0V \times 1.1mA)$$
$$P_{D(150mA)} = 375mW$$

$$P_{D(8.2\%DC)} = \%DC \times P_{D(150mA)}$$
$$P_{D(8.2\%DC)} = 0.082 \times 375mW$$
$$P_{D(8.2\%DC)} = 30.75mW$$

The power dissipation for a 150mA load occurring for 8.2% of the duty cycle will be 20.9mW. Finally, the two power dissipation levels can be summed to determine the total true power dissipation under the varied load.

$$P_{D(total)} = P_{D(100mA)} + P_{D(150mA)}$$
$$P_{D(total)} = 229.5mW + 30.75mW$$
$$P_{D(total)} = 260.25mW$$

The maximum power dissipation for the AAT3221/2 operating at an ambient temperature of 85°C is 267mW. The device in this example will have a total power dissipation of 260.25mW. This is within the thermal limits for safe operation of the device.

### Printed Circuit Board Layout Recommendations

In order to obtain the maximum performance from the AAT3221/2 LDO regulator, very careful attention must be considered in regard to the printed circuit board layout. If grounding connections are not properly made, power supply ripple rejection and LDO regulator transient response can be compromised.

The LDO Regulator external capacitors  $C_{IN}$  and  $C_{OUT}$  should be connected as directly as possible to the ground pin of the LDO Regulator. For maximum performance with the AAT3221/2, the ground pin connection should then be made directly back to the ground or common of the source power supply. If a direct ground return path is not possible due to printed circuit board layout limitations, the LDO ground pin should then be connected to the common ground plane in the application layout.

### Ordering Information

Output Voltage	Enable	Package	Marking	Part Number	
				Bulk	Tape and Reel
1.8V	Active high	SOT23-5		N/A	AAT3221IGV-1.8-T1
2.0V	Active high	SOT23-5		N/A	AAT3221IGV-2.0-T1
2.3V	Active high	SOT23-5		N/A	AAT3221IGV-2.3-T1
2.4V	Active high	SOT23-5		N/A	AAT3221IGV-2.4-T1
2.5V	Active high	SOT23-5		N/A	AAT3221IGV-2.5-T1
2.7V	Active high	SOT23-5		N/A	AAT3221IGV-2.7-T1
2.8V	Active high	SOT23-5		N/A	AAT3221IGV-2.8-T1
2.85V	Active high	SOT23-5		N/A	AAT3221IGV-2.85-T1
3.0V	Active high	SOT23-5		N/A	AAT3221IGV-3.0-T1
3.3V	Active high	SOT23-5		N/A	AAT3221IGV-3.3-T1
3.5V	Active high	SOT23-5		N/A	AAT3221IGV-3.5-T1
1.8V	Active high	SC70JW-8		N/A	AAT3221IJS-1.8-T1
2.0V	Active high	SC70JW-8		N/A	AAT3221IJS-2.0-T1
2.3V	Active high	SC70JW-8		N/A	AAT3221IJS-2.3-T1
2.4V	Active high	SC70JW-8		N/A	AAT3221IJS-2.4-T1
2.5V	Active high	SC70JW-8		N/A	AAT3221IJS-2.5-T1
2.7V	Active high	SC70JW-8		N/A	AAT3221IJS-2.7-T1
2.8V	Active high	SC70JW-8		N/A	AAT3221IJS-2.8-T1
2.85V	Active high	SC70JW-8		N/A	AAT3221IJS-2.85-T1
3.0V	Active high	SC70JW-8		N/A	AAT3221IJS-3.0-T1
3.3V	Active high	SC70JW-8		N/A	AAT3221IJS-3.3-T1
3.5V	Active high	SC70JW-8		N/A	AAT3221IJS-3.5-T1
1.8V	Active high	SOT23-5		N/A	AAT3222IGV-1.8-T1
1.8V	Active high	SOT23-5		N/A	AAT3222IGV-1.8-T1
2.0V	Active high	SOT23-5		N/A	AAT3222IGV-2.0-T1
2.3V	Active high	SOT23-5		N/A	AAT3222IGV-2.3-T1
2.4V	Active high	SOT23-5		N/A	AAT3222IGV-2.4-T1
2.5V	Active high	SOT23-5		N/A	AAT3222IGV-2.5-T1
2.7V	Active high	SOT23-5		N/A	AAT3222IGV-2.7-T1
2.8V	Active high	SOT23-5		N/A	AAT3222IGV-2.8-T1
2.85V	Active high	SOT23-5		N/A	AAT3222IGV-2.85-T1
3.0V	Active high	SOT23-5		N/A	AAT3222IGV-3.0-T1
3.3V	Active high	SOT23-5		N/A	AAT3222IGV-3.3-T1
3.5V	Active high	SOT23-5		N/A	AAT3222IGV-3.5-T1
2.8V	Active low	SOT23-5		N/A	AAT3221IGV-2.8-2 T1

### Package Information

#### SOT23-5

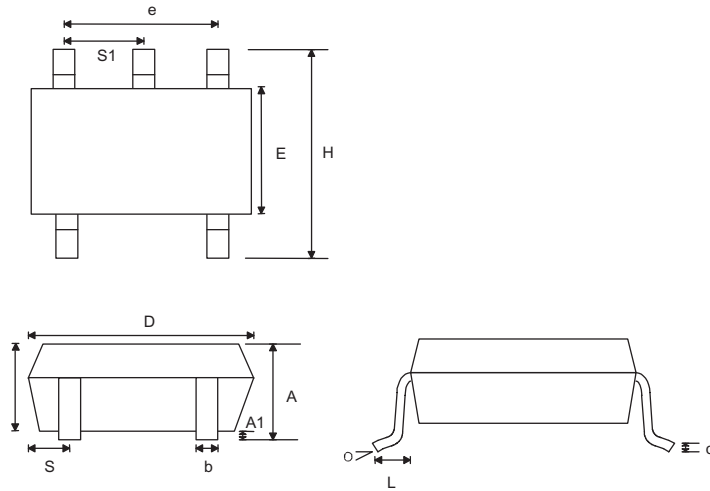

Dim	Millimeters		Inches	
	Min	Max	Min	Max
A	0.95	1.45	0.037	0.057
A1	0.05	0.15	0.002	0.006
A2	0.90	1.30	0.035	0.051
b	0.35	0.50	0.014	0.019
c	0.08	0.20	0.003	0.078
D	2.84	3.00	0.112	0.112
E	1.50	1.70	0.059	0.067
e	1.90		0.0748	
H	2.60	3.00	0.102	0.118
L	0.35	0.55	.0137	.0216
S	0.47	0.55	0.019	.0216
S1	.95		0.037	
θ	0°	10°	0°	10°

#### SC70JW-8

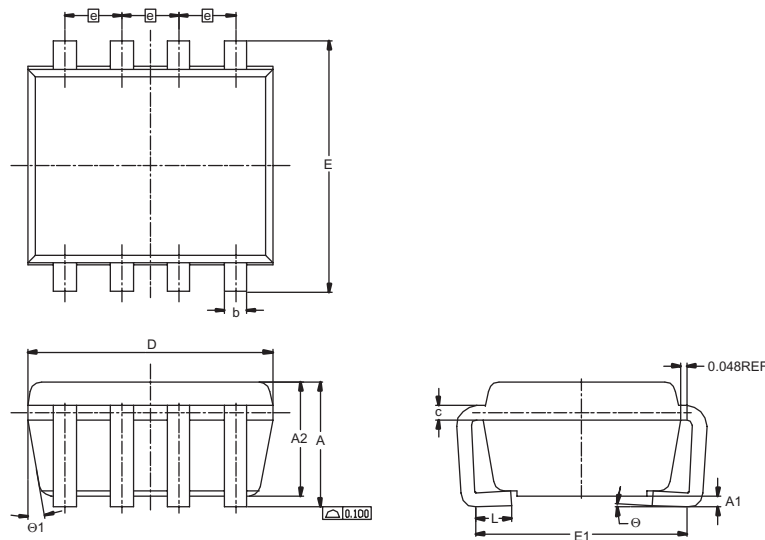

Dim	Millimeters		Inches	
	Min	Max	Min	Max
E	2.10 BSC		0.083 BSC	
E1	1.75	2.00	0.069	0.079
L	0.23	0.40	0.009	0.016
A		1.10		0.043
A1	0	0.10		0.004
A2	0.70	1.00	0.028	0.039
D	2.00 BSC		0.079 BSC	
e	0.50 BSC		0.020 BSC	
b	0.15	0.30	0.006	0.012
c	0.10	0.20	0.004	0.008
θ	0	8°	0	8°
θ1	4°	10°	4°	10°



**AAT3221/2**  
**150mA NanoPower™ LDO Linear Regulator**

---

This page intentionally left blank

**Advanced Analogic Technologies, Inc.**  
1250 Oakmead Parkway, Suite 310, Sunnyvale, CA 94086  
Phone (408) 524-9684  
Fax (408) 524-9689

