

- 5 output functions •
- Amplified in d.c. + a.c. 2 wires •
- Cable output •

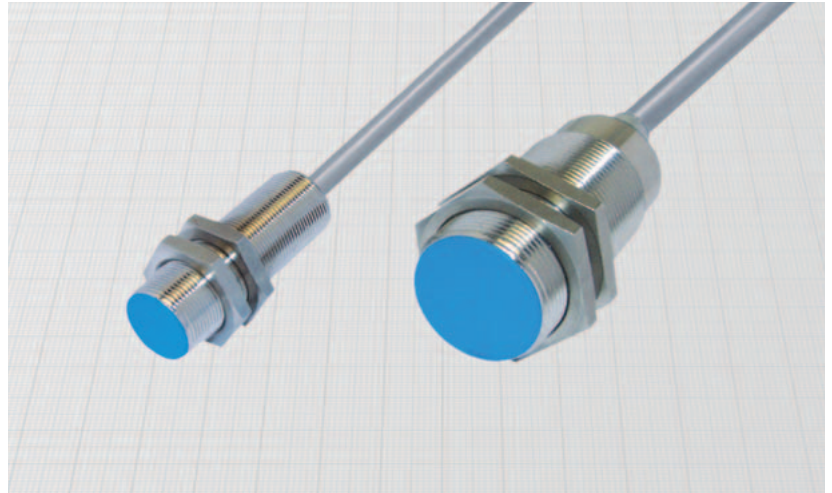
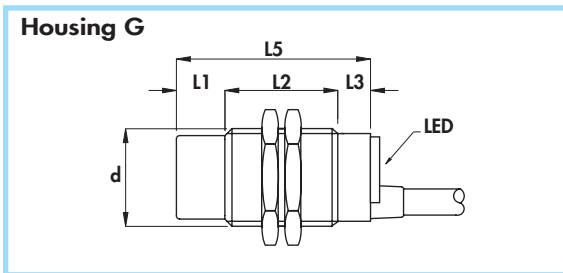
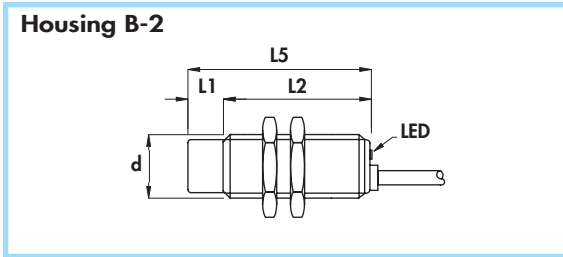

Diameter	M18 x 1	M30 x 1,5
Nut	Size	SW24
	Thickness mm	4
Max tightening torque Nm	35	80

Materials:

- Cable: 2 m PVC CEI 20 - 22 II; 90°C; 300 V; O.R.
- Housing: nickel plated brass
- Sensing face: plastic

General Features:

When used in a.c. they work as normally open. When used in d.c. they can work as normally open or normally closed simply by reversing the connection wires. The load can be connected indifferently on the positive or on the negative pole. These sensors put together the four functions of traditional 3 wires amplified sensors: PNP - NO; PNP - NC; NPN - NO; NPN - NC. Besides the a.c. working in many applications they can replace directly electromechanical microswitches.

Technical data:

- Supply voltage (U_B): 10 ÷ 60 Vdc/Vac
- Electrical system frequency: 40 ÷ 60 Hz
- Max ripple: 10%
- Off-state current (I_i): ≤ 0,6 mA
- Minimum operational current (I_m): 5 mA
- Rated operational current (I_o): 400 mA
- Voltage drop (U_d): ≤ 4 V
- Temperature range: -20° ÷ +70°C
- Max thermal drift of sensing distance S_r : ± 10%
- Repeat accuracy (R): 2%
- Switching hysteresis (H): 10%
- Degree of protection: IP67
- LED indication: yellow = output state
blinking red = output short circuit
- Cable conductor cross section: 0,75 mm²
- Protected against short-circuit and overload
- Suppression of initial false impulse
- Class 2 equipment according to IEC 536
- Shock and vibration according to EN60068-2-27 EN60068-2-6
- Electromagnetic compatibility (EMC) according to EN61000-6-2/-4

Housing	Flush mounting Non flush mounting	L1	L2	L3	L5	Cable diameter	Body diameter (d)	Max switching frequency (f)	Nominal sensing distance (S_n) ± 10%	ORDERING REFERENCES					
										PNP		NPN		A.C.	
										NO	NC	NO	NC	NO	
B - 2	•	-	50	-	50	5	M18 x 1	800	5		DX18/4A5XKS DX18/5A5XKS				
B - 2	•	10	40	-	50	5	M18 x 1	400	8						
G	•	-	50	10	60	5	M30 x 1,5	600	10	DX30/465XKS DX30/565XKS					
G	•	15	35	10	60	5	M30 x 1,5	300	15						

CYLINDRICAL INDUCTIVE SENSORS IN METAL HOUSING

- 5 output functions
- Amplified in d.c. + a.c. 2 wires
- Connector output M12 x 1

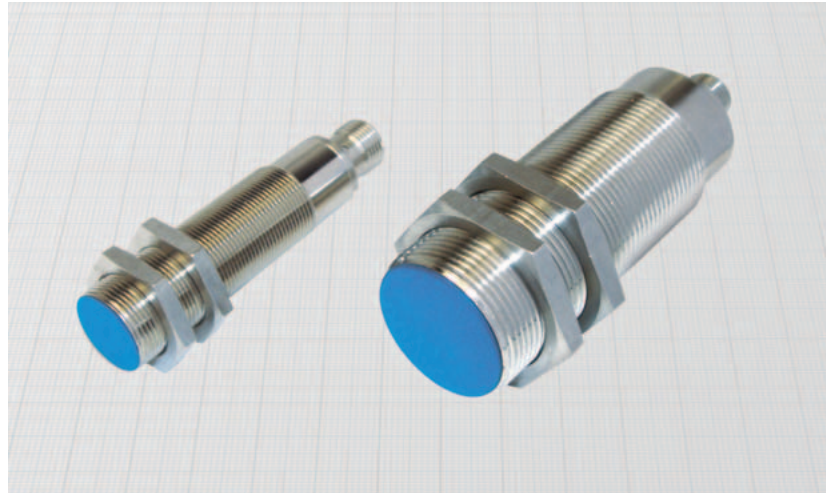
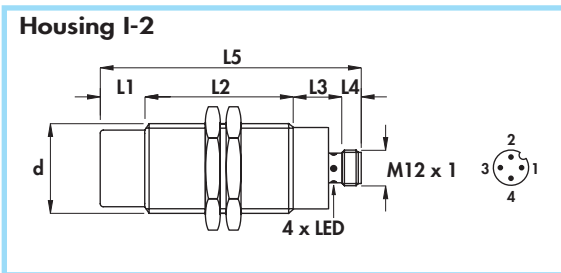
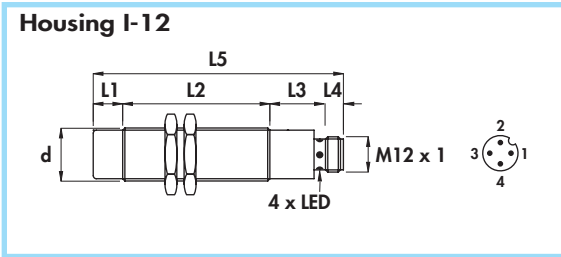

Diameter	M18 x 1	M30 x 1,5
Nut	Size	SW24
	Thickness mm	4
Max tightening torque Nm	35	80

Materials:

- Housing: nickel plated brass
- Sensing face: plastic

General Features:

When used in a.c. they work as normally open. When used in d.c. they can work as normally open or normally closed simply by reversing the connection wires. The load can be connected indifferently on the positive or on the negative pole. These sensors put together the four functions of traditional 3 wires amplified sensors besides the a.c. working. In many applications they can replace directly electromechanical microswitches.

Technical data:

- Supply voltage (U_B): 10 ÷ 60 Vdc/Vac
- Electrical system frequency: 40 ÷ 60 Hz
- Max ripple: 10%
- Off-state current (I_o): ≤ 0,6 mA
- Minimum operational current (I_m): 5 mA
- Voltage drop (U_d): ≤ 4 V
- Temperature range: -20° ÷ +70°C
- Max thermal drift of sensing distance S_s : ± 10%
- Repeat accuracy (R): 2%
- Switching hysteresis (H): 10%
- Degree of protection: IP67
- Switch status indicator: yellow LED
- Protected against short-circuit and overload
- Suppression of initial false impulse
- Class 2 equipment according to IEC 536
- Shock and vibration according to EN60068-2-27 EN60068-2-6
- Electromagnetic compatibility (EMC) according to EN60947-5-2

Housing	Flush mounting Non flush mounting	L1	L2	L3	L4	L5	Female connector	Body diameter (d)	Max switching frequency (f)	Rated operational current (I _e)	Nominal sensing distance (S _n) ± 10%	ORDERING REFERENCES			
												PNP		NPN	A.C.
												mm	mm	mm	mm
I-12	•	-	50	19	8	77	6-8B-10	M18 x 1	800	400	5		DX18/435XKS DX18/535XKS		
I-12	•	10	50	19	8	87	6-8B-10	M18 x 1	400	400	8				
I-2	•	-	65	17	8	90	6-8B-10	M30 x 1,5	600	400	10		DX30/435XKS DX30/535XKS		
I-2	•	15	50	17	8	90	6-8B-10	M30 x 1,5	300	400	15				

Voltage 10 ÷ 50 V_~ •
Amplified in d.c. + a.c. 2 wires •
Cable output •

Housing B-6

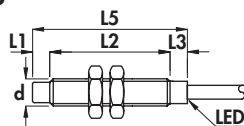

Housing B-3

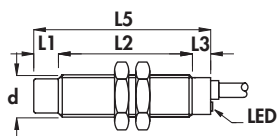

Housing C

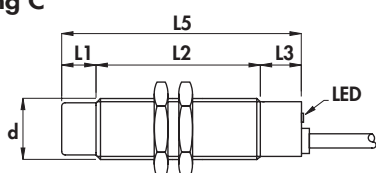

Housing G

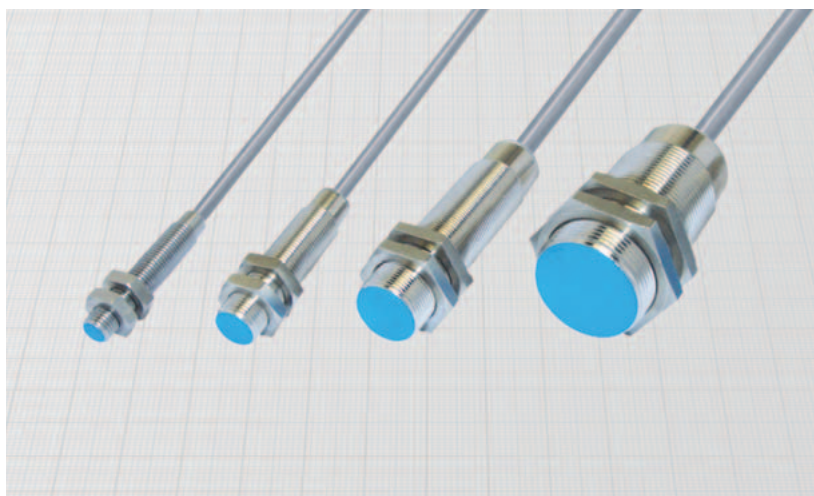
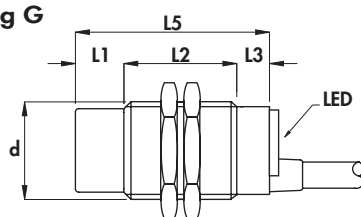

Diameter		M8 x 1	M12 x 1	M18 x 1	M30 x 1,5
Nut	Size	SW13	SW17	SW24	SW36
	Thickness mm	4	4	4	5
Max tightening torque Nm		10	15	35	80

Materials:

- Cable: 2 m PVC CEI 20 - 22 II; 90°C; 300 V; O.R.
- Housing 8 mm: stainless steel
- Housing 12 - 18 - 30 mm: nickel plated brass
- Sensing face: plastic

General Features:

These sensors are able to work with either direct or alternate current. Voltage drop and residual current are very low. They are not polarized and the load can be connected on both the leads. In many applications they can be used to replace mechanical microswitches.

Technical data:

- Supply voltage (U_B): 10 ÷ 50 Vdc/Vac
- Electrical system frequency: 40 ÷ 60 Hz
- Off-state current (I_o): ≤ 1 mA
- Minimum operational current (I_m): 5 mA
- Voltage drop (U_d): ≤ 5 V
- Temperature range: -25° ÷ +70°C
- Max thermal drift of sensing distance S_r : ± 10%
- Repeat accuracy (R): 2%
- Switching hysteresis (H): 10%
- Degree of protection: IP67
- Switch status indicator: yellow LED
- Cable conductor cross section: 0,35 mm² on 8 and 12 mm
0,50 mm² on 18 mm
0,75 mm² on 30 mm
- Protected against short-circuit and overload (versions with letter K)
- Suppression of initial false impulse
- Electromagnetic compatibility (EMC) according to EN60947-5-2
- Shock and vibration resistance according to EN60068-2-27 EN60068-2-6

Housing	Flush mounting Non flush mounting	L1	L2	L3	L4	L5	Cable diameter	Body diameter (d)	Max switching frequency (f) in d.c.	Max switching frequency (f) in a.c.	Rated operational current (I _e)	Nominal sensing distance (S _n) ± 10%	ORDERING REFERENCES	
													mm	mm
B-6	•	-	40	5	-	45	4	M8 x 1	1000	25	100	1,5	AXM8/4600S	AXM8/4610S
B-6	•	5	35	5	-	45	4	M8 x 1	800	25	100	2,5	AXM8/5600S	AXM8/5610S
B-3	•	-	43	7	-	50	4	M12 x 1	800	25	100	2	AXM12/4600KS	AXM12/4610KS
B-3	•	7	36	7	-	50	4	M12 x 1	600	25	100	4	AXM12/5600KS	AXM12/5610KS
C	•	-	58	12	-	70	5	M18 x 1	800	25	200	5	AXM18/4600KS	AXM18/4610KS
C	•	10	48	12	-	70	5	M18 x 1	400	25	200	8	AXM18/5600KS	AXM18/5610KS
G	•	-	50	10	-	60	6	M30 x 1,5	400	25	200	10	AXM30/4600KS	AXM30/4610KS
G	•	15	35	10	-	60	6	M30 x 1,5	200	25	200	15	AXM30/5600KS	AXM30/5610KS

CYLINDRICAL INDUCTIVE SENSORS IN METAL HOUSING

- Supply 10 ÷ 50 V \approx
- Amplified in d.c. + a.c.
- Connector output M12 x 1

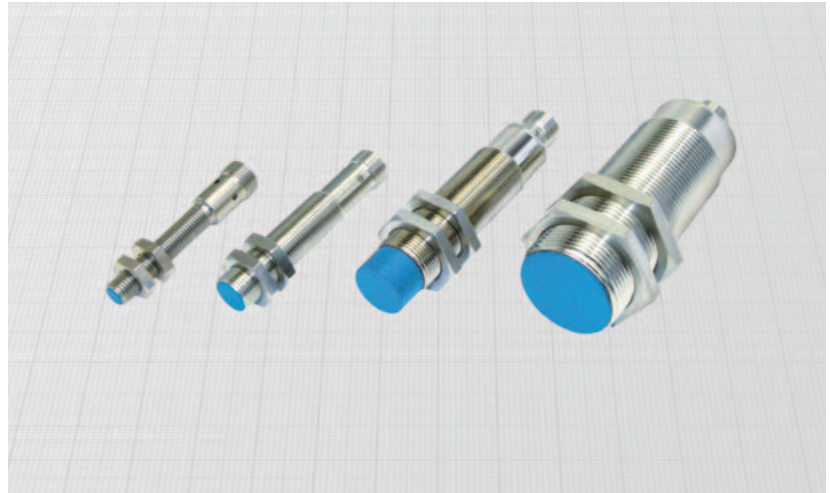
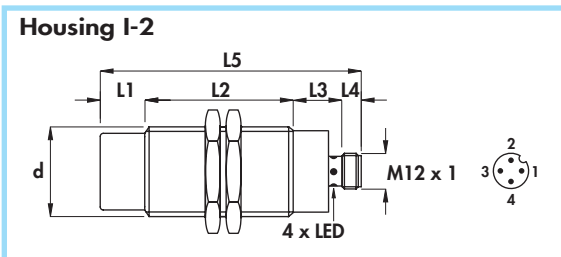
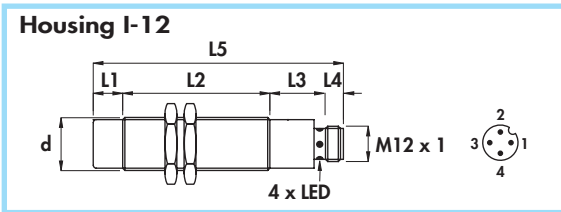
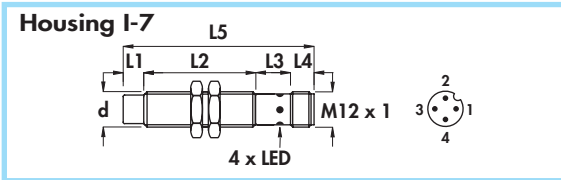
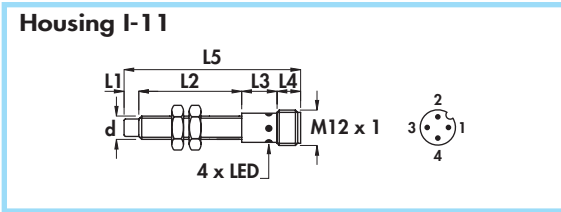

Diameter	M8 x 1	M12 x 1	M18 x 1	M30 x 1,5
Nut	Size	SW13	SW17	SW24
	Thickness mm	4	4	4
Max tightening torque Nm	10	15	35	80

Materials:

- Housing 8 mm: stainless steel
- Housing 12 - 18 - 30 mm: nickel plated brass
- Sensing face: plastic

General Features:

These sensors are able to work with either direct or alternate current. Voltage drop and residual current are very low. They are not polarized and the load can be connected on both the leads. In many applications they can be used to replace mechanical microswitches.

Technical data:

- Supply voltage (U_B): 10 ÷ 50 Vdc/Vac
- Electrical system frequency: 40 ÷ 60 Hz
- Off-state current (I_o): ≤ 1 mA
- Minimum operational current (I_m): 5 mA
- Voltage drop (U_d): ≤ 5 V
- Temperature range: -25° ÷ +70°C
- Max thermal drift of sensing distance S_T : $\pm 10\%$
- Repeat accuracy (R): 2%
- Switching hysteresis (H): 10%
- Degree of protection: IP67
- Switch status indicator: yellow LED
- Protected against short-circuit and overload (versions with letter K)
- Suppression of initial false impulse
- Electromagnetic compatibility (EMC) according to EN60947-5-2
- Shock and vibration resistance according to EN60068-2-27 EN60068-2-6

Housing	Flush mounting Non flush mounting	L1	L2	L3	L4	L5	Female connector	Body diameter (d)	Max switching frequency (f) in d.c.	Max switching frequency (f) in a.c.	Rated operational current (I_e)	Nominal sensing distance (S_n) $\pm 10\%$	ORDERING REFERENCES		
													mm	mm	mm
I-11	•	-	40	12	8	60	6-8B-10	M8 x 1	1000	25	100	1,5		AXM8/4300S	AXM8/4310S
I-11	•	5	35	12	8	60	6-8B-10	M8 x 1	800	25	100	2,5		AXM8/5300S	AXM8/5310S
I-7	•	-	43	15	8	66	6-8B-10	M12 x 1	800	25	100	2		AXM12/4300KS	AXM12/4310KS
I-7	•	7	36	15	8	66	6-8B-10	M12 x 1	600	25	100	4		AXM12/5300KS	AXM12/5310KS
I-12	•	-	50	19	8	77	6-8B-10	M18 x 1	800	25	200	5		AXM18/4300KS	AXM18/4310KS
I-12	•	10	50	19	8	87	6-8B-10	M18 x 1	400	25	200	8		AXM18/5300KS	AXM18/5310KS
I-2	•	-	65	17	8	90	6-8B-10	M30 x 1,5	400	25	200	10		AXM30/4300KS	AXM30/4310KS
I-2	•	15	50	17	8	90	6-8B-10	M30 x 1,5	200	25	200	15		AXM30/5300KS	AXM30/5310KS

Voltage 20 ÷ 240 V_~ •
Amplified in d.c. + a.c. 2 wires •
Cable output •

Housing B-6

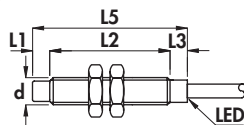

Housing B-3

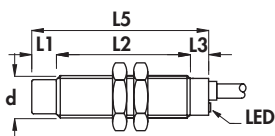

Housing B-2

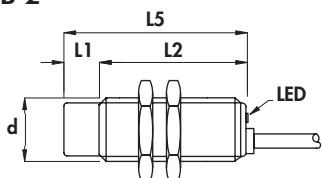

Housing G

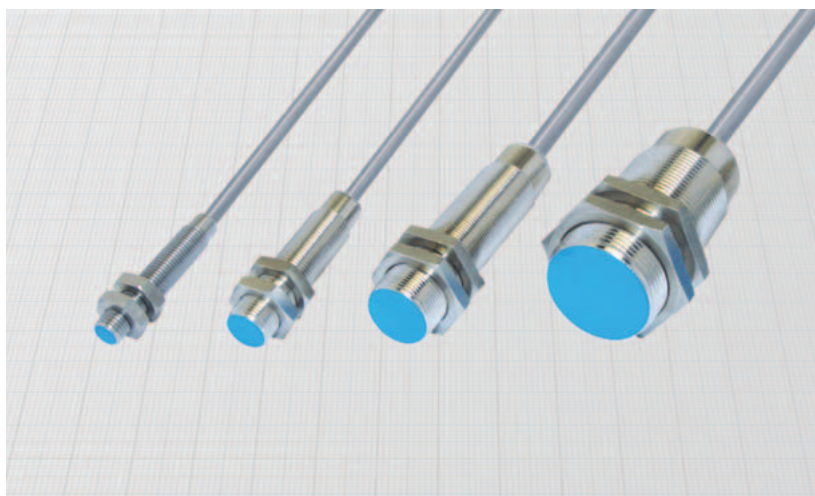
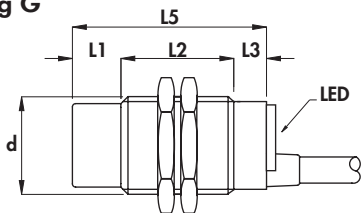

General Features:

These sensors are able to work with either direct or alternate current. Voltage drop and residual current are very low. They are not polarized and the load can be connected on both the leads. In many applications they can be used to replace mechanical microswitches.

Technical data:

- Supply voltage (U_B): 20 ÷ 240 Vdc/Vac
- Electrical system frequency: 40 ÷ 60 Hz
- Off-state current (I_o) at 24 V: ≤ 1 mA
- Off-state current (I_o) at 220 V: ≤ 1,5 mA
- Minimum operational current (I_m): 5 mA
- Voltage drop (U_d): ≤ 5 V
- Temperature range: - 25° ÷ + 70°C
- Max thermal drift of sensing distance S_r : ± 10%
- Repeat accuracy (R): 2%
- Switching hysteresis (H): 10%
- Degree of protection: IP67
- Switch status indicator: yellow LED
- Cable conductor cross section: 0,35 mm² on 8 and 12 mm
0,50 mm² on 18 mm
0,75 mm² on 30 mm

- Protected against short-circuit and overload (versions with letter K)
- Suppression of initial false impulse
- Class 2 equipment according to IEC 536
- Shock and vibration according to EN60068-2-27 EN60068-2-6
- Electromagnetic compatibility (EMC) according to EN60947-5-2

Diameter		M8 x 1	M12 x 1	M18 x 1	M30 x 1,5
Nut	Size	SW13	SW17	SW24	SW36
	Thickness mm	4	4	4	5
Max tightening torque Nm		10	15	35	80

Materials:

- Cable: 2 m PVC CEI 20 - 22 II; 90°C; 300 V; O.R.
- Housing 8 mm: stainless steel
- Housing 12 - 18 - 30 mm: nickel plated brass
- Sensing face: plastic

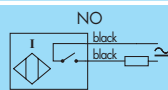
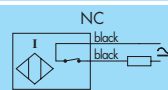
Housing	Flush mounting Non flush mounting	L1	L2	L3	L4	L5	Cable diameter	Body diameter (d)	Max switching frequency (f) in d.c.	Max switching frequency (f) in a.c.	Rated operational current (I _o)	Nominal sensing distance (S ₀) ± 10%	ORDERING REFERENCES	
		mm	mm	mm	mm	mm								
B-6	•	-	40	5	-	45	3,5	M8 x 1	1000	25	100	1,5	AX8/4609S	AX8/4619S
B-6	•	5	35	5	-	45	3,5	M8 x 1	800	25	100	2,5	AX8/5609S	AX8/5619S
B-3	•	-	43	7	-	50	4	M12 x 1	800	25	100	2	AX12/4609KS	AX12/4619KS
B-3	•	7	36	7	-	50	4	M12 x 1	600	25	100	4	AX12/5609KS	AX12/5619KS
B-2	•	-	50	-	-	50	5	M18 x 1	800	25	200	5	AX18/4A09KS	AX18/4A19KS
B-2	•	10	40	-	-	50	5	M18 x 1	400	25	200	8	AX18/5A09KS	AX18/5A19KS
G	•	-	50	10	-	60	6	M30 x 1,5	400	25	200	10	AX30/4609KS	AX30/4619KS
G	•	15	35	10	-	60	6	M30 x 1,5	200	25	200	15	AX30/5609KS	AX30/5619KS

CYLINDRICAL INDUCTIVE SENSORS IN METAL HOUSING

- Voltage 20 ÷ 240 V \approx
- Amplified in d.c. + a.c.
- Connector output M12 x 1

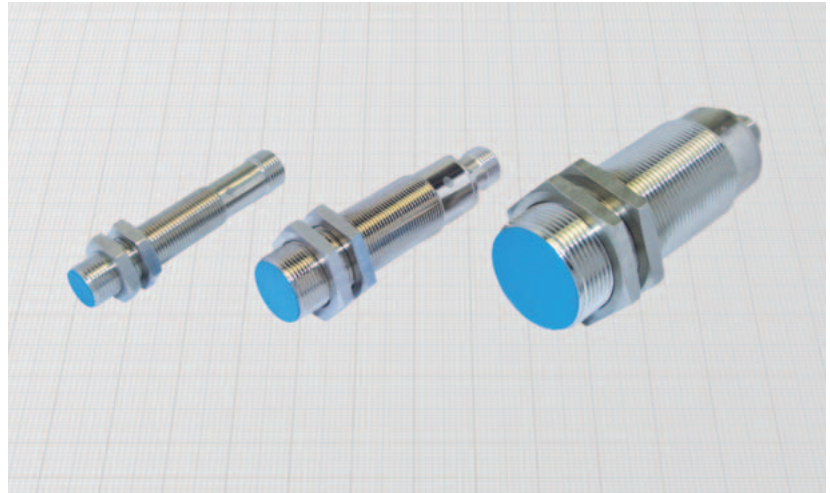
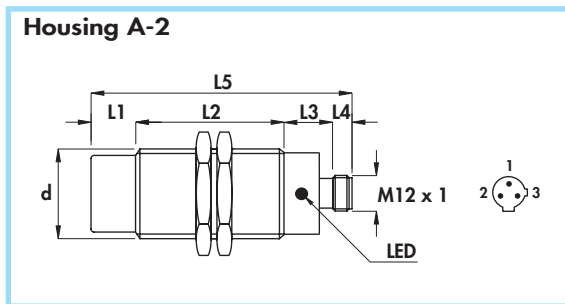
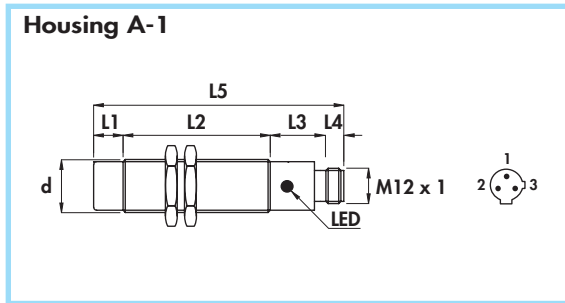
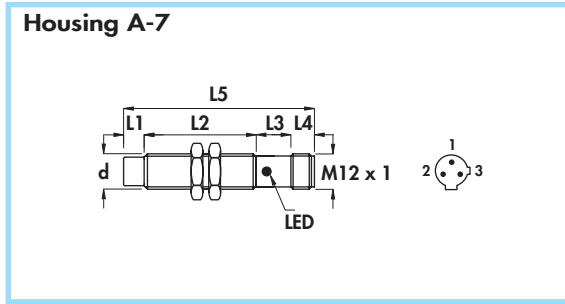

Diameter		M12x 1	M18 x 1	M30 x 1,5
Nut	Size	SW17	SW24	SW36
	Thickness mm	4	4	5
Max tightening torque Nm		15	35	80

Materials:

- Housing: nickel plated brass
- Sensing face: plastic

General Features:

These sensors are able to work with either direct or alternate current. Voltage drop and residual current are very low. They are not polarized and the load can be connected on both the leads. In many applications they can be used to replace mechanical microswitches.

Technical data:

- Supply voltage (U_B): 20 ÷ 240 Vdc/Vac
- Electrical system frequency: 40 ÷ 60 Hz
- Off-state current (I_o) at 24 V: ≤ 1 mA
- Off-state current (I_o) at 220 V: $\leq 1,5$ mA
- Minimum operational current (I_m): 5 mA
- Voltage drop (U_d): ≤ 5 V
- Temperature range: -25° ÷ +70°C
- Max thermal drift of sensing distance S_p : $\pm 10\%$
- Repeat accuracy (R): 2%
- Switching hysteresis (H): 10%
- Degree of protection: IP67
- Switch status indicator: yellow LED
- Protected against short-circuit and overload
- Suppression of initial false impulse
- Class 2 equipment according to IEC 536
- Shock and vibration according to EN60068-2-27 EN60068-2-6
- Electromagnetic compatibility (EMC) according to EN60947-5-2

Housing	Flush mounting Non flush mounting	L1	L2	L3	L4	L5	Female connector	Body diameter (d)	Max switching frequency (f) in d.c.	Max switching frequency (f) in a.c.	Rated operational current (I_o)	Nominal sensing distance (S_p) $\pm 10\%$	ORDERING REFERENCES	
		mm	mm	mm	mm	mm							n°	mm
A-7	•	-	43	15	8	66	17-18	M12 x 1	800	25	100	2	AX12/4009KS	AX12/4019KS
A-7	•	7	36	15	8	66	17-18	M12 x 1	600	25	100	4	AX12/5009KS	AX12/5019KS
A-1	•	-	50	19	8	77	17-18	M18 x 1	800	25	200	5	AX18/4009KS	AX18/4019KS
A-1	•	10	50	19	8	87	17-18	M18 x 1	400	25	200	8	AX18/5009KS	AX18/5019KS
A-2	•	-	65	17	8	90	17-18	M30 x 1,5	400	25	200	10	AX30/4009KS	AX30/4019KS
A-2	•	15	50	17	8	90	17-18	M30 x 1,5	200	25	200	15	AX30/5009KS	AX30/5019KS