

MITSUBISHI IGBT MODULES
CM450HA-5F
 HIGH POWER SWITCHING USE
 INSULATED TYPE

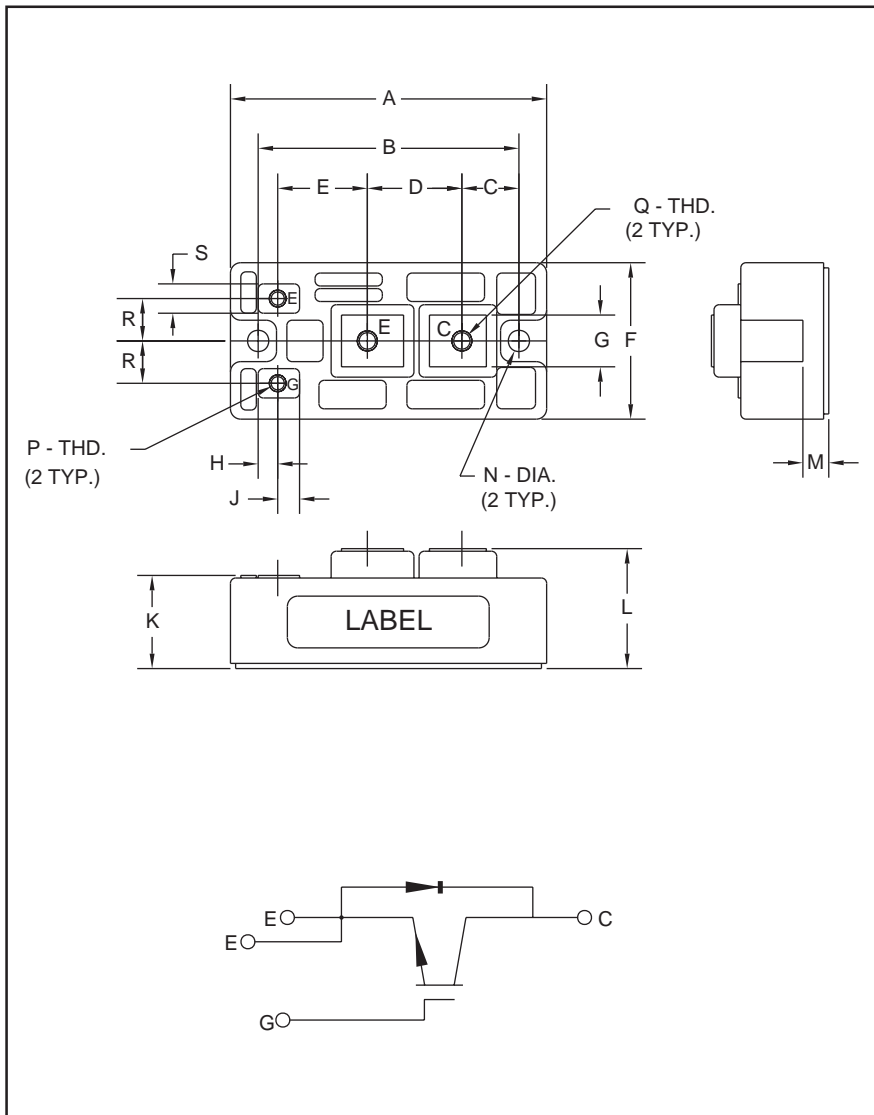

Outline Drawing and Circuit Diagram



Description:

Mitsubishi IGBT Modules are designed for use in switching applications. Each module consists of one IGBT in a single configuration, with a reverse connected super-fast recovery free-wheel diode. All components and interconnects are isolated from the heat sinking baseplate, offering simplified system assembly and thermal management.

Features:

- Low Drive Power
- Low $V_{CE(sat)}$
- Discrete Super-Fast Recovery Free-Wheel Diodes
- High Frequency Operation
- Isolated Baseplate for Easy Heat Sinking

Applications:

- UPS
- Forklift

Ordering Information:

Example: Select the complete nine digit module part number you desire from the table below - i.e. CM450HA-5F is a 250V (V_{CES}), 450 Ampere Single IGBT Module.

Type	Current Rating Amperes	V_{CES} Volts (x 50)
CM	450	5

Dimensions	Inches	Millimeters
A	3.82	97.0
B	3.15	80.0
C	0.69	17.5
D	1.14	29.0
E	1.04	26.5
F	1.89	48.0
G	0.63	16.0
H	0.24	6.0
J	0.26	6.7

Dimensions	Inches	Millimeters
K	1.14	29.0 ^{+1.0} _{-0.5}
L	1.42	36.0 ^{+1.0} _{-0.5}
M	0.28	7.0
N	0.26 Dia.	Dia. 6.5
P	M4 Metric	M4
Q	M6 Metric	M6
R	0.51	13.0
S	0.35	9.0

CM450HA-5F

HIGH POWER SWITCHING USE
INSULATED TYPE

Absolute Maximum Ratings, $T_j = 25^\circ\text{C}$ unless otherwise specified

	Symbol	Ratings	Units
Junction Temperature	T_j	-40 to 150	$^\circ\text{C}$
Storage Temperature	T_{stg}	-40 to 125	$^\circ\text{C}$
Collector-Emitter Voltage (G-E Short)	V_{CES}	250	Volts
Gate-Emitter Voltage (C-E Short)	V_{GES}	± 20	Volts
Collector Current ($T_C = 25^\circ\text{C}$)	I_C	450	Amperes
Peak Collector Current ($T_j \leq 150^\circ\text{C}$)	I_{CM}	900*	Amperes
Emitter Current** ($T_C = 25^\circ\text{C}$)	I_E	450	Amperes
Peak Emitter Current**	I_{EM}	900*	Amperes
Maximum Collector Dissipation ($T_C = 25^\circ\text{C}$)	P_C	735	Watts
Mounting Torque, M6 Main Terminal	—	1.96 ~ 2.94	$\text{N} \cdot \text{m}$
Mounting Torque, M6 Mounting	—	1.96 ~ 2.94	$\text{N} \cdot \text{m}$
Mounting Torque, M4 Terminal	—	0.98 ~ 1.47	$\text{N} \cdot \text{m}$
Weight	—	270	Grams
Isolation Voltage (Main Terminal to Baseplate, AC 1 min.)	V_{iso}	2500	V_{rms}

*Pulse width and repetition rate should be such that the device junction temperature (T_j) does not exceed $T_{j(\text{max})}$ rating.

**Represents characteristics of the anti-parallel, emitter-to-collector free-wheel diode (FWDi).

Static Electrical Characteristics, $T_j = 25^\circ\text{C}$ unless otherwise specified

Characteristics	Symbol	Test Conditions	Min.	Typ.	Max.	Units
Collector-Cutoff Current	I_{CES}	$V_{\text{CE}} = V_{\text{CES}}, V_{\text{GE}} = 0\text{V}$	—	—	1.0	mA
Gate Leakage Current	I_{GES}	$V_{\text{GE}} = V_{\text{GES}}, V_{\text{CE}} = 0\text{V}$	—	—	0.5	μA
Gate-Emitter Threshold Voltage	$V_{\text{GE(th)}}$	$I_C = 45\text{mA}, V_{\text{CE}} = 10\text{V}$	3.0	4.0	5.0	Volts
Collector-Emitter Saturation Voltage	$V_{\text{CE(sat)}}$	$I_C = 450\text{A}, V_{\text{GE}} = 10\text{V},$	—	1.2	1.7**	Volts
		$I_C = 450\text{A}, V_{\text{GE}} = 10\text{V}, T_j = 150^\circ\text{C}$	—	1.1	—	Volts
Total Gate Charge	Q_G	$V_{\text{CC}} = 100\text{V}, I_C = 450\text{A}, V_{\text{GE}} = 10\text{V}$	—	1760	—	nC
Emitter-Collector Voltage	V_{EC}	$I_E = 450\text{A}, V_{\text{GE}} = 0\text{V}$	—	—	2.0	Volts

** Pulse width and repetition rate should be such that device junction temperature rise is negligible.

Dynamic Electrical Characteristics, $T_j = 25^\circ\text{C}$ unless otherwise specified

Characteristics	Symbol	Test Conditions	Min.	Typ.	Max.	Units
Input Capacitance	C_{ies}		—	—	132	nF
Output Capacitance	C_{oes}	$V_{\text{GE}} = 0\text{V}, V_{\text{CE}} = 10\text{V}$	—	—	6	nF
Reverse Transfer Capacitance	C_{res}		—	—	4.5	nF
Resistive	Turn-on Delay Time	$V_{\text{CC}} = 100\text{V}, I_C = 450\text{A},$	—	—	1200	ns
	Rise Time					
Load	Turn-off Delay Time	$V_{\text{GE1}} = V_{\text{GE2}} = 10\text{V}, R_G = 5.6\Omega,$	—	—	900	ns
	Fall Time					
Switching		Resistive Load	—	—	500	ns
Diode Reverse Recovery Time	t_{rr}	$I_E = 450\text{A}, di_E/dt = -900\text{A}/\mu\text{s}$	—	—	300	ns
Diode Reverse Recovery Charge	Q_{rr}	$I_E = 450\text{A}, di_E/dt = -900\text{A}/\mu\text{s}$	—	7.6	—	μC

Thermal and Mechanical Electrical Characteristics, $T_j = 25^\circ\text{C}$ unless otherwise specified

Characteristics	Symbol	Test Conditions	Min.	Typ.	Max.	Units
Thermal Resistance, Junction to Case	$R_{\text{th(j-c)}}$	Per IGBT	—	—	0.17	$^\circ\text{C}/\text{W}$
Thermal Resistance, Junction to Case	$R_{\text{th(j-c)}}$	Per Free Wheel Diode	—	—	0.23	$^\circ\text{C}/\text{W}$
Contact Thermal Resistance	$R_{\text{th(c-f)}}$	Per Module, Thermal Grease Applied	—	—	0.090	$^\circ\text{C}/\text{W}$

CM450HA-5F

HIGH POWER SWITCHING USE
INSULATED TYPE

OUTPUT CHARACTERISTICS
(TYPICAL)

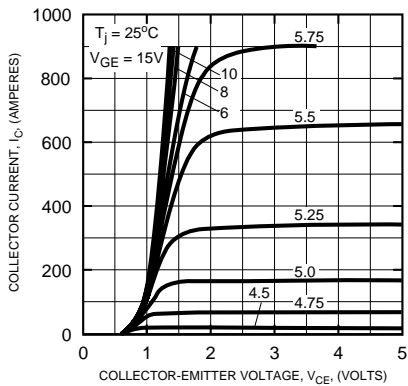

TRANSFER CHARACTERISTICS
(TYPICAL)

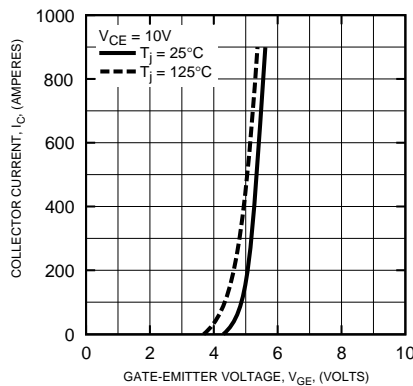

COLLECTOR-EMITTER SATURATION VOLTAGE CHARACTERISTICS
(TYPICAL)

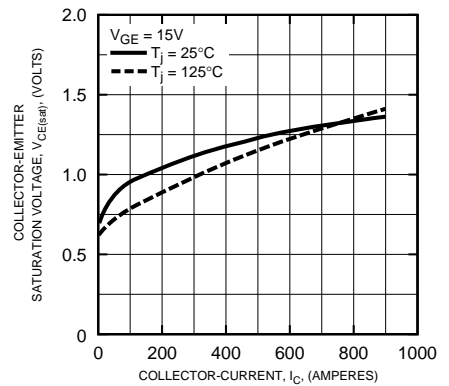

COLLECTOR-EMITTER SATURATION VOLTAGE CHARACTERISTICS
(TYPICAL)

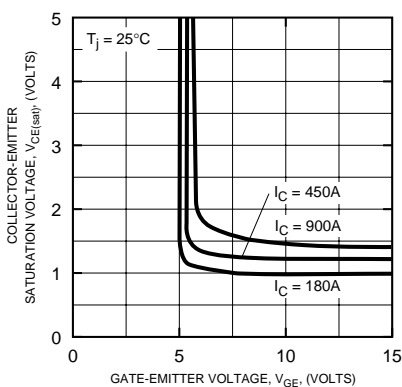

FREE-WHEEL DIODE FORWARD CHARACTERISTICS
(TYPICAL)

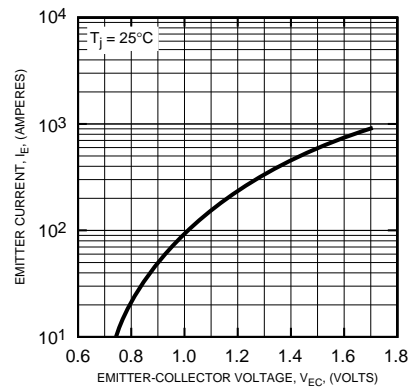

CAPACITANCE VS. V_{CE}
(TYPICAL)

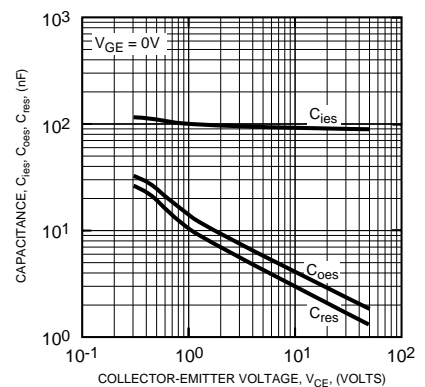

HALF-BRIDGE SWITCHING CHARACTERISTICS
(TYPICAL)

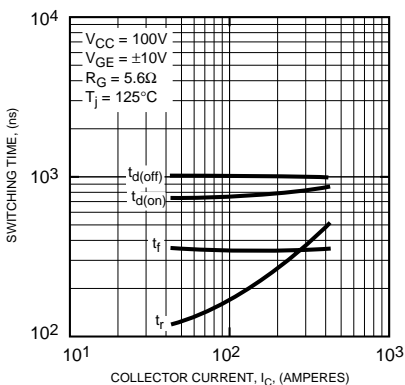

REVERSE RECOVERY CHARACTERISTICS
(TYPICAL)

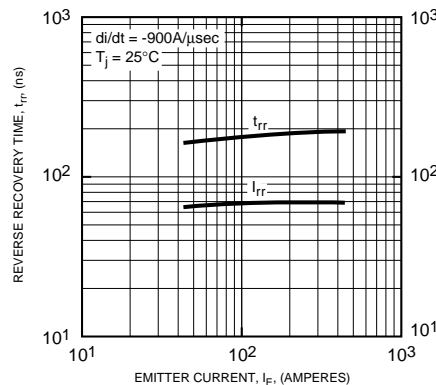

GATE CHARGE, V_{GE}

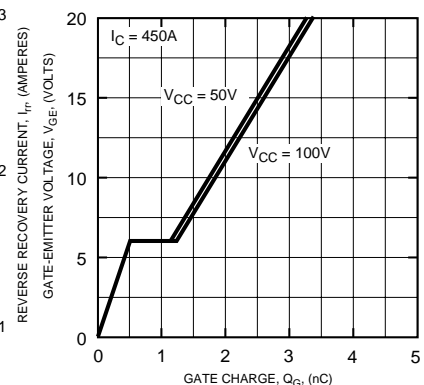

CM450HA-5F

HIGH POWER SWITCHING USE
INSULATED TYPE

**TRANSIENT THERMAL
IMPEDANCE CHARACTERISTICS
(IGBT)**

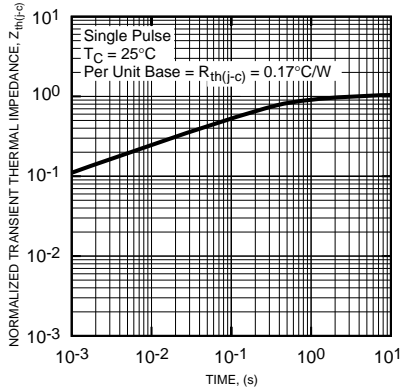

**TRANSIENT THERMAL
IMPEDANCE CHARACTERISTICS
(FWDi)**

