

Features

- 168 Pin JEDEC Standard, 8 Byte Dual In-line Memory Module
- 4Mx72 (Dual Bank) Fast Page Mode DIMM
- Performance:

		-60	-70
t _{RAC}	RAS Access Time	60ns	70ns
t _{CAC}	CAS Access Time	20ns	25ns
t _{AA}	Access Time From Address	35ns	40ns
t _{RC}	Cycle Time	110ns	130ns
t _{PC}	Fast Page Mode Cycle Time	40ns	45ns
- All inputs and outputs are LVTTTL (3.3V) or TTL (5.0V) compatible
- Single 3.3V ± 0.3V or 5.0V ± 0.5V Power Supply

- Au contacts
- Optimized for ECC applications
- System Performance Benefits:
 - Buffered inputs (except $\overline{\text{RAS}}$, Data)
 - Reduced noise (32 V_{SS}/V_{CC} pins)
 - Buffered PDs
- Fast Page Mode, Read-Modify-Write Cycles
- Refresh Modes: $\overline{\text{RAS}}$ -Only, CBR and Hidden Refresh
- 2048 refresh cycles distributed across 32ms
- 11/10 addressing (Row/Column)
- Card size: 5.25" x 1.5" x 0.157"
- DRAMs in TSOP Package

Description

IBM11M4730H is an industry standard 168-pin 8-byte Dual In-line Memory Module (DIMM) which is organized as a 4Mx72 high speed memory array, designed for ECC applications, and is configured as 2 2Mx72 banks. The DIMM uses 18 2Mx8 DRAMs in TSOP packages.

Improved system performance is provided by the on-DIMM buffering of selected input signals. The specified timings include all buffer, net and skew delays, which simplifies the memory subsystem design analysis. The data and $\overline{\text{RAS}}$ signals are not buffered, which preserves the DRAM access specifications of 60ns and 70ns.

Presence Detect (PD) and Identification Detect (ID)

bits provide information about the DIMM density, addressing, performance and features. PD bits can be dotted at the system level and activated for each DIMM position using the PD enable ($\overline{\text{PDE}}$) signal. ID bits also allow detection of card features, and may be dot-or'd at the system level to provide information for the entire DIMM bank. For example, the system will determine that ECC DIMMs are installed if PD8 is low (0). ID0 need not be sensed since both x72 and x80 ECC DIMMs will function in a x72 bank.

All IBM 168-pin DIMMs provide a high performance, flexible 8-byte interface in a 5.25" long space-saving footprint. Related products are the x64 and x72 parity (5V) DIMMs and ECC DIMMs (5V and 3.3V).

Card Outline (3.3V)

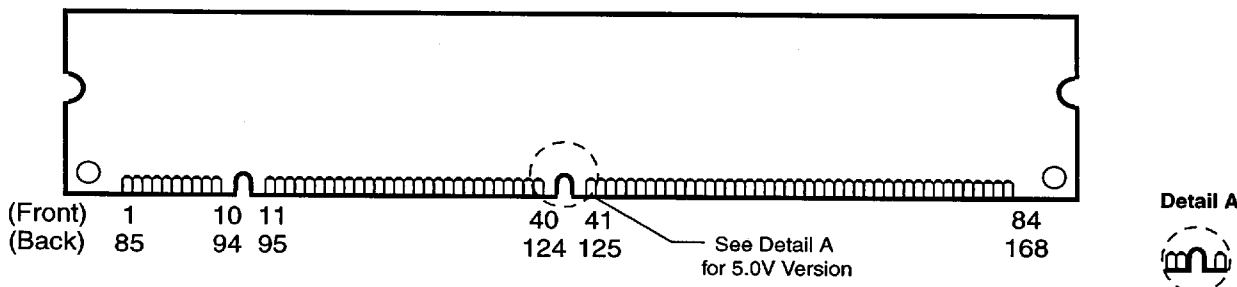



Pin Description

RAS0, RAS1, RAS2, RAS3	Row Address Strobe	V _{CC}	Power (3.3V or 5.0V)
CAS0, CAS1, CAS4, CAS5	Column Address Strobe (Buffered)	V _{SS}	Ground
WE0, WE2	Read/write Input (Buffered)	NC	No Connect
OE0, OE2	Output Enable (Buffered)	PD1 - PD8	Presence Detects (Buffered)
A0, B0, A1 - A10	Address Inputs (Buffered)	FDE	Presence Detect Enable
DQx	Data Input/Output	ID0 - ID1	ID Bits

Pinout

Pin#	Front Side	Pin#	Back Side	Pin#	Front Side	Pin#	Back Side	Pin#	Front Side	Pin#	Back Side	Pin#	Front Side	Pin#	Back Side
1	V _{SS}	85	V _{SS}	22	DQ17	106	DQ53	43	V _{SS}	127	V _{SS}	64	NC	148	NC
2	DQ0	86	DQ36	23	V _{SS}	107	V _{SS}	44	OE2	128	NC	65	DQ25	149	DQ61
3	DQ1	87	DQ37	24	NC	108	NC	45	RAS2	129	RAS3	66	DQ26	150	DQ62
4	DQ2	88	DQ38	25	NC	109	NC	46	CAS4	130	CAS5	67	DQ27	151	DQ63
5	DQ3	89	DQ39	26	V _{CC}	110	V _{CC}	47	NC	131	NC	68	V _{SS}	152	V _{SS}
6	V _{CC}	90	V _{CC}	27	WE0	111	NC	48	WE2	132	FDE	69	DQ28	153	DQ64
7	DQ4	91	DQ40	28	CAS0	112	CAS1	49	V _{CC}	133	V _{CC}	70	DQ29	154	DQ65
8	DQ5	92	DQ41	29	NC	113	NC	50	NC	134	NC	71	DQ30	155	DQ66
9	DQ6	93	DQ42	30	RAS0	114	RAS1	51	NC	135	NC	72	DQ31	156	DQ67
10	DQ7	94	DQ43	31	OE0	115	NC	52	DQ18	136	DQ54	73	V _{CC}	157	V _{CC}
11	DQ8	95	DQ44	32	V _{SS}	116	V _{SS}	53	DQ19	137	DQ55	74	DQ32	158	DQ68
12	V _{SS}	96	V _{SS}	33	A0	117	A1	54	V _{SS}	138	V _{SS}	75	DQ33	159	DQ69
13	DQ9	97	DQ45	34	A2	118	A3	55	DQ20	139	DQ56	76	DQ34	160	DQ70
14	DQ10	98	DQ46	35	A4	119	A5	56	DQ21	140	DQ57	77	DQ35	161	DQ71
15	DQ11	99	DQ47	36	A6	120	A7	57	DQ22	141	DQ58	78	V _{SS}	162	V _{SS}
16	DQ12	100	DQ48	37	A8	121	A9	58	DQ23	142	DQ59	79	PD1	163	PD2
17	DQ13	101	DQ49	38	A10	122	NC	59	V _{CC}	143	V _{CC}	80	PD3	164	PD4
18	V _{CC}	102	V _{CC}	39	NC	123	NC	60	DQ24	144	DQ60	81	PD5	165	PD6
19	DQ14	103	DQ50	40	V _{CC}	124	V _{CC}	61	NC	145	NC	82	PD7	166	PD8
20	DQ15	104	DQ51	41	NC	125	NC	62	NC	146	NC	83	ID0	167	ID1
21	DQ16	105	DQ52	42	NC	126	B0	63	NC	147	NC	84	V _{CC}	168	V _{CC}

Note: All pin assignments are consistent for all 8 Byte versions.

Ordering Information

Part Number	Organization	Speed	Addr.	Leads	Dimension	Power	Notes
IBM11M4730H-60	4Mx72	60ns	11/10	Au	5.25"x1.5"x 0.157"	5.0V	
IBM11M4730H-70		70ns					
IBM11M4730H-60T		60ns					1
IBM11M4730H-70T		70ns					1
IBM11M4730HB-60		60ns				3.3V	
IBM11M4730HB-70		70ns					
IBM11M4730HB-60T		60ns					1
IBM11M4730HB-70T		70ns					1

1. DRAM package designator appended to speed portion of part number on assemblies beginning with DRAM die rev E.

Block Diagram x72 ECC DIMM (2 Bank, x8 DRAMs)

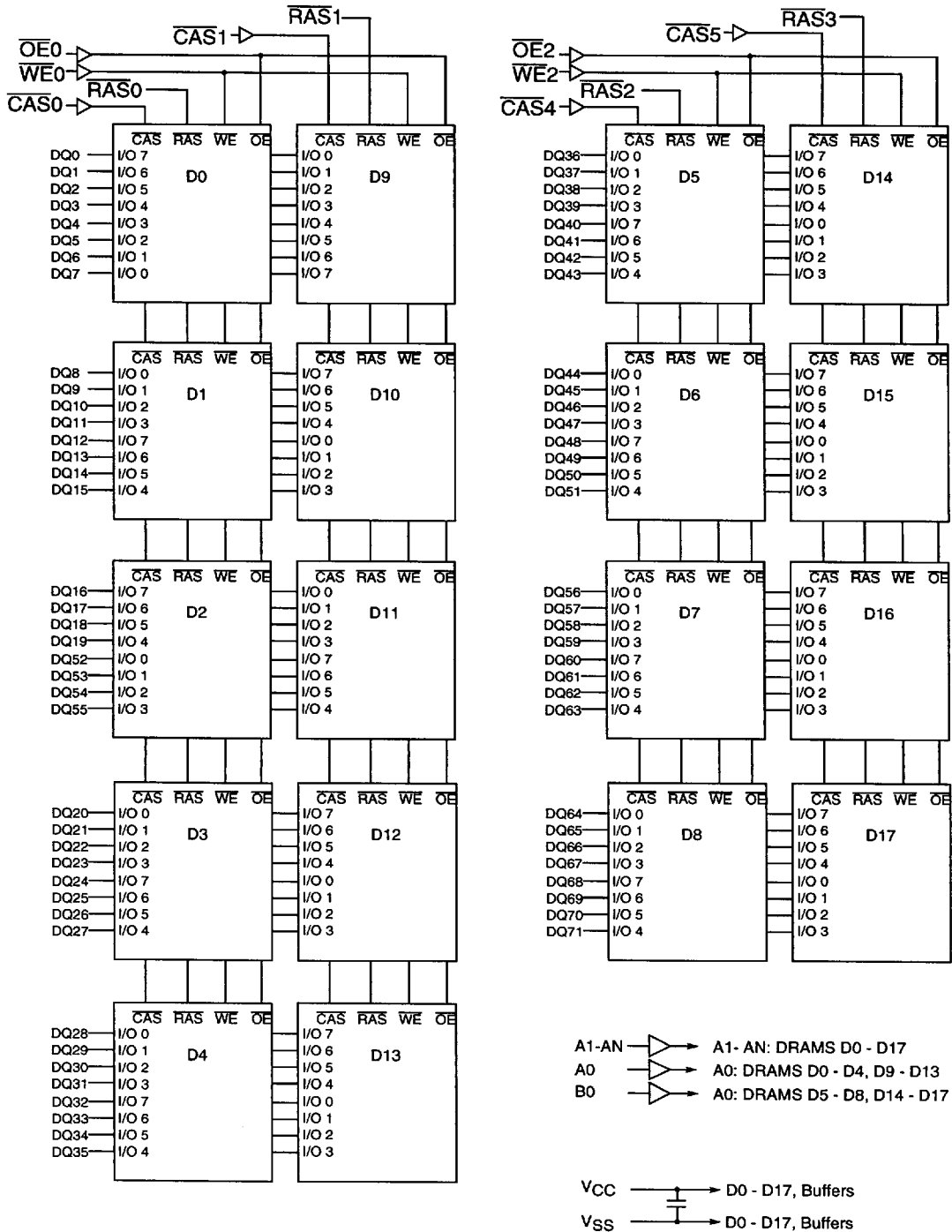



Truth Table

Function	$\overline{\text{RAS}}$	$\overline{\text{CAS}}$	$\overline{\text{WE}}$	$\overline{\text{OE}}$	Row Address	Column Address	$\overline{\text{PDE}}$	DQx	
Standby	H	H→X	X	X	X	X	X	High Impedance	
Read	L	L	H	L	Row	Col	X	Valid Data Out	
Early-Write	L	L	L	X	Row	Col	X	Valid Data In	
Late-Write / RMW	L	L	H→L	L→H	Row	Col	X	Valid Data Out, Valid Data In	
Fast Page Mode - Read 1st Cycle	L	H→L	H	L	Row	Col	X	Valid Data Out	
Subsequent Cycles	L	H→L	H	L	N/A	Col	X	Valid Data Out	
Fast Page Mode - Write 1st Cycle	L	H→L	L	X	Row	Col	X	Valid Data In	
Subsequent Cycles	L	H→L	L	X	N/A	Col	X	Valid Data In	
Fast Page Mode - RMW 1st Cycle	L	H→L	H→L	L→H	Row	Col	X	Valid Data Out, Valid Data In	
Subsequent Cycles	L	H→L	H→L	L→H	N/A	Col	X	Valid Data Out, Valid Data In	
$\overline{\text{RAS}}$ -Only Refresh	L	H	X	X	Row	N/A	X	High Impedance	
$\overline{\text{CAS}}$ -Before- $\overline{\text{RAS}}$ Refresh	H→L	L	H	X	X	X	X	High Impedance	
Hidden Refresh	Read	L→H→L	L	H	L	Row	Col	X	Data Out
	Write	L→H→L	L	H	X	Row	Col	X	Data In
Read Presence Detects	X	X	X	X	X	X	L	Not Affected (PD Bits Valid)	

Presence Detect

Pin	-60	-70
PD1 (PD1 - PD4: Addressing/Density)	0	0
PD2	1	1
PD3	0	0
PD4	1	1
PD5 (EDO Detection)	0	0
PD6 (PD6 - PD7: Speed)	1	0
PD7	1	1
PD8 (Parity/ECC Designator)	0	0
ID0 (DIMM Type/Width)	0	0
ID1 (Refresh Mode)	0	0

1. PD1-8 are buffered outputs (0 = driven to V_{OL} , 1 = open)
2. ID0-1 are unbuffered outputs (0 = V_{SS} , 1 = open)
3. $\overline{\text{PDE}}$ should be tied high or low at system level if not used



Absolute Maximum Ratings

Symbol	Parameter	Rating (3.3V)	Rating (5.0V)	Units	Notes
V _{CC}	Power Supply Voltage	-0.5 to +4.6	-1.0 to +7.0	V	1
V _{IN}	Input Voltage	-0.5 to min (V _{CC} + 0.5, 4.6)	-0.5 to min (V _{CC} + 0.5, 7.0)	V	1
V _{OUT}	Output Voltage	-0.5 to min (V _{CC} + 0.5, 4.6)	-0.5 to min (V _{CC} + 0.5, 7.0)	V	1
T _{OPR}	Operating Temperature	0 to +70	0 to +70	°C	1
T _{STG}	Storage Temperature	-55 to +125	-55 to +125	°C	1
P _D	Power Dissipation	5.8	8.9	W	1, 2
I _{OUT}	Short Circuit Output Current	50	50	mA	1
I _{OUTPD}	Short Circuit Output Current (PD)	60	60	mA	1

1. Stresses greater than those listed may cause permanent damage to the device. This is a stress rating only and functional operation of the device at these or any other conditions above those indicated is not implied. Exposure to absolute maximum rating condition for extended periods may affect reliability.
2. Maximum power occurs when all banks are active (refresh cycle).

Recommended DC Operating Conditions (T_A = 0 to 70°C)

Symbol	Parameter	3.3V			5.0V			Units	Notes
		Min	Typ	Max	Min	Typ	Max		
V _{CC}	Supply Voltage	3.0	3.3	3.6	4.5	5.0	5.5	V	1
V _{IH}	Input High Voltage	2.0	—	V _{CC} + 0.5	2.4	—	V _{CC} + 0.5	V	1, 2
V _{IL}	Input Low Voltage	-0.5	—	0.8	-0.5	—	0.8	V	1, 2

1. All voltages referenced to V_{SS}.
2. V_{IH} may overshoot to V_{CC} + 1.2V for pulse widths of ≤ 4.0ns with 3.3 Volt, or V_{CC} + 2.0V for pulse widths of ≤ 4.0ns (or V_{CC} + 1.0V for ≤ 8.0ns) with 5.0 Volt. Additionally, V_{IL} may undershoot to -2.0V for pulse widths ≤ 4.0ns (or -1.0V for ≤ 8.0ns). Pulse widths measured at 50% points with amplitude measured peak to DC reference.

Capacitance (T_A = 0 to +70°C, V_{CC} = 3.3V ± 0.3V or 5.0V ± 0.5V)

Symbol	Parameter	Max	Units
C _{I1}	Input Capacitance (A0, B0, A1-A10)	13	pF
C _{I2}	Input Capacitance ($\overline{\text{RAS}}$)	RAS0, 1	40 pF
		RAS2, 3	35 pF
C _{I3}	Input Capacitance ($\overline{\text{CAS}}$, $\overline{\text{WE}}$, $\overline{\text{OE}}$)	13	pF
C _{I4}	Input Capacitance ($\overline{\text{PDE}}$)	18	pF
C _{IO1}	Input/Output Capacitance (DQx)	22	pF
C _{O1}	Output Capacitance (PD)	15	pF
C _{O2}	Output Capacitance (ID)	5	pF

DC Electrical Characteristics ($T_A = 0$ to $+70^\circ\text{C}$, $V_{CC} = 3.3\text{V} \pm 0.3\text{V}$ or $V_{CC} = 5.0\text{V} \pm 0.5\text{V}$)

Symbol	Parameter	Min.	Max.	Units	Notes	
I_{CC1}	Operating Current Average Power Supply Operating Current ($\overline{\text{RAS}}$, $\overline{\text{CAS}}$, Address Cycling: $t_{RC} = t_{RC}$ min.)	-60	—	828	mA	1, 2, 3
		-70	—	738		
I_{CC2}	Standby Current (TTL) Power Supply Standby Current ($\overline{\text{RAS}} = \overline{\text{CAS}} = V_{IH}$)	—	—	36	mA	
I_{CC3}	$\overline{\text{RAS}}$ Only Refresh Current Average Power Supply Current, $\overline{\text{RAS}}$ Only Mode ($\overline{\text{RAS}}$ Cycling, $\overline{\text{CAS}} = V_{IH}$; $t_{RC} = t_{RC}$ min)	-60	—	828	mA	1, 3, 4
		-70	—	738		
I_{CC4}	Fast Page Mode Current Average Power Supply Current, Fast Page Mode ($\overline{\text{RAS}} = V_{IL}$, $\overline{\text{CAS}}$, Address Cycling: $t_{PC} = t_{PC}$ min)	-60	—	468	mA	1, 2, 3
		-70	—	378		
I_{CC5}	Standby Current (CMOS) Power Supply Standby Current ($\overline{\text{RAS}} = \overline{\text{CAS}} = V_{CC} - 0.2\text{V}$)	—	—	18	mA	
I_{CC6}	$\overline{\text{CAS}}$ Before $\overline{\text{RAS}}$ Refresh Current Average Power Supply Current, $\overline{\text{CAS}}$ Before $\overline{\text{RAS}}$ Mode ($\overline{\text{RAS}}$, $\overline{\text{CAS}}$, Cycling: $t_{RC} = t_{RC}$ min)	-60	—	828	mA	1, 3, 4
		-70	—	738		
$I_{I(L)}$	Input Leakage Current Input Leakage Current, any input ($0.0 \leq V_{IN} \leq (V_{CC} + 0.3\text{V})$), All Other Pins Not Under Test = 0V	$\overline{\text{CAS}}$, WE, OE, A0, B0, A1 - A10	-10	+10	μA	
		DQ	-20	+20		
		$\overline{\text{RAS}}0, 1$	-50	+50		
		$\overline{\text{RAS}}2, 3$	-40	+40		
$I_{O(L)}$	Output Leakage Current (D_{OUT} is disabled, $0.0 \leq V_{OUT} \leq V_{CC}$)	—	—	-20	+20	μA
V_{OH}	Output Level (TTL) Output "H" Level Voltage ($I_{OUT} = -2.5\text{mA}$ for 3.3V, or $I_{OUT} = -5\text{mA}$ for 5.0V)	—	—	2.4	V_{CC}	V
V_{OL}	Output Level (TTL) Output "L" Level Voltage ($I_{OUT} = +2.1\text{mA}$ for 3.3V, or $I_{OUT} = +4.2\text{mA}$ for 5.0V)	—	—	0.0	0.4	V

1. I_{CC1} , I_{CC3} , I_{CC4} and I_{CC6} depend on cycle rate.
 2. I_{CC1} and I_{CC4} depend on output loading. Specified values are obtained with the output open.
 3. Address can be changed once or less while $\overline{\text{RAS}} = V_{IL}$. In the case of I_{CC4} , it can be changed once or less when $\overline{\text{CAS}} = V_{IH}$.
 4. Refresh current is specified for 1 bank active and 1 bank standby.

AC Characteristics ($T_A = 0$ to $+70^\circ\text{C}$, $V_{CC} = 3.3\text{V} \pm 0.3\text{V}$ or $5.0\text{V} \pm 0.5\text{V}$)

1. V_{IH} (min) and V_{IL} (max) are reference levels for measuring timing of input signals. Transition times are measured between V_{IH} and V_{IL} .
2. An initial pause of $200\mu\text{s}$ is required after power-up followed by 8 $\overline{\text{RAS}}$ only refresh cycles before proper device operation is achieved. In case of using internal refresh counter, a minimum of 8 $\overline{\text{CAS}}$ before $\overline{\text{RAS}}$ refresh cycles instead of 8 $\overline{\text{RAS}}$ only refresh cycles is required.
3. The specified timings include buffer, loading and skew delay adders: 2ns minimum, 5ns maximum delay, no pulse shrinkage to the Dram device timings. The data and $\overline{\text{RAS}}$ signals are not buffered, which preserves the DRAMs access specifications of 60ns and 70ns.
4. AC measurements assume $t_T = 5\text{ns}$.

Read, Write, Read-Modify-Write and Refresh Cycles (Common Parameters)

Symbol	Parameter	-60		-70		Unit	Notes
		Min	Max	Min	Max		
t_{RC}	Random Read or Write Cycle Time	110	—	130	—	ns	
t_{RP}	$\overline{\text{RAS}}$ Precharge Time	40	—	50	—	ns	
t_{CP}	$\overline{\text{CAS}}$ Precharge Time	10	—	10	—	ns	
t_{RAS}	$\overline{\text{RAS}}$ Pulse Width	60	10K	70	10K	ns	
t_{CAS}	$\overline{\text{CAS}}$ Pulse Width	15	10K	20	10K	ns	1
t_{ASR}	Row Address Setup Time	5	—	5	—	ns	
t_{RAH}	Row Address Hold Time	8	—	8	—	ns	
t_{ASC}	Column Address Setup Time	2	—	2	—	ns	
t_{CAH}	Column Address Hold Time	10	—	10	—	ns	
t_{RCD}	$\overline{\text{RAS}}$ to $\overline{\text{CAS}}$ Delay Time	18	40	18	45	ns	2
t_{RAD}	$\overline{\text{RAS}}$ to Column Address Delay Time	13	25	13	30	ns	3
t_{RSH}	$\overline{\text{RAS}}$ Hold Time	20	—	25	—	ns	
t_{CSH}	$\overline{\text{CAS}}$ Hold Time	58	—	68	—	ns	
t_{CRP}	$\overline{\text{CAS}}$ to $\overline{\text{RAS}}$ Precharge Time	10	—	10	—	ns	
t_{ODD}	$\overline{\text{OE}}$ to D_{IN} Delay Time	20	—	25	—	ns	4
t_{DZO}	$\overline{\text{OE}}$ Delay Time from D_{IN}	-2	—	-2	—	ns	5
t_{DZC}	$\overline{\text{CAS}}$ Delay Time from D_{IN}	-2	—	-2	—	ns	5
t_{AR}	Column Address Hold Time Referenced to $\overline{\text{RAS}}$	—	—	—	—	—	6
t_T	Transition Time (Rise and Fall)	3	30	3	30	ns	

1. The minimum t_{CAS} requires t_{CSH} to be met for both writes and reads. Also, because of the buffer, the minimum t_{CAS} for a read cycle must be extended to guarantee the data out window (t_{OH}) in the application. For example, a t_{CAS} of 15ns plus a minimum t_{OH} of 2ns would result in turning data out of the DIMM at 17ns (3ns before max t_{CAC} of 20ns).
2. Operation within the $t_{RCD}(\text{max})$ limit ensures that $t_{RAC}(\text{max})$ can be met. The $t_{RCD}(\text{max})$ is specified as a reference point only: If t_{RCD} is greater than the specified $t_{RCD}(\text{max})$ limit, then access time is controlled by t_{CAC} .
3. Operation within the $t_{RAD}(\text{max})$ limit ensures that $t_{RAC}(\text{max})$ can be met. The $t_{RAD}(\text{max})$ is specified as a reference point only: If t_{RAD} is greater than the specified $t_{RAD}(\text{max})$ limit, then access time is controlled by t_{AA} .
4. Either t_{CDD} or t_{ODD} must be satisfied.
5. Either t_{DZC} or t_{DZO} must be satisfied.
6. This timing parameter is not applicable to this product, but applies to a related product in this family.



Write Cycle

Symbol	Parameter	-60		-70		Unit	Notes
		Min	Max	Min	Max		
t_{WCS}	Write Command Set Up Time	2	—	2	—	ns	1
t_{WCH}	Write Command Hold Time	17	—	17	—	ns	
t_{WP}	Write Command Pulse Width	15	—	15	—	ns	
t_{RWL}	Write Command to \overline{RAS} Lead Time	20	—	25	—	ns	
t_{CWL}	Write Command to \overline{CAS} Lead Time	17	—	22	—	ns	
t_{WCR}	Write Command Hold Time Referenced to \overline{RAS}	—	—	—	—	ns	2
t_{DHR}	Data Hold Time Referenced to \overline{RAS}	—	—	—	—	ns	2
t_{DS}	D_{IN} Setup Time	-2	—	-2	—	ns	3
t_{DH}	D_{IN} Hold Time	17	—	20	—	ns	3

- t_{WCS} , t_{RWD} , t_{CWD} , t_{AWD} , and t_{CPW} are not restrictive parameters. They are included in the data sheet as electrical characteristics only. If $t_{WCS} \geq t_{WCS}(\text{min.})$, the entire cycle is an early write cycle and the data pin will remain open circuit (high impedance) through the entire cycle; If $t_{RWD} \geq t_{RWD}(\text{min.})$, $t_{CWD} \geq t_{CWD}(\text{min.})$, $t_{AWD} \geq t_{AWD}(\text{min.})$ and $t_{CPW} \geq t_{CPW}(\text{min.})$ (Fast Page Mode), the cycle is a Read-Modify-Write cycle and the data will contain read from the selected cell; If neither of the above sets of conditions are met, the condition of the data (at access time) is indeterminate.
- This timing parameter is not applicable to this product, but applies to a related product in this family.
- Data-in set-up and hold is measured from the latter of the two timings, \overline{CAS} or \overline{WE} .

Read Cycle

Symbol	Parameter	-60		-70		Unit	Notes
		Min	Max	Min	Max		
t_{RAC}	Access Time from \overline{RAS}	—	60	—	70	ns	1, 2
t_{CAC}	Access Time from \overline{CAS}	—	20	—	25	ns	1, 2
t_{AA}	Access Time from Address	—	35	—	40	ns	1, 2
t_{OEA}	Access Time from \overline{OE}	—	20	—	25	ns	1, 2
t_{RCS}	Read Command Setup Time	2	—	2	—	ns	
t_{RCH}	Read Command Hold Time to \overline{CAS}	2	—	2	—	ns	3
t_{RRH}	Read Command Hold Time to \overline{RAS}	0	—	0	—	ns	3
t_{RAL}	Column Address to \overline{RAS} Lead Time	35	—	40	—	ns	
t_{CAL}	Column Address to \overline{CAS} Lead Time	35	—	40	—	ns	
t_{CLZ}	\overline{CAS} to Output in Low-Z	2	—	2	—	ns	
t_{ROH}	\overline{RAS} Hold to Output Enable	—	—	—	—	ns	4
t_{OH}	Output Data Hold Time	2	—	2	—	ns	
t_{OHO}	Output Data Hold Time from \overline{OE}	2	—	2	—	ns	
t_{OEZ}	Output Buffer Turn-off Delay from \overline{OE}	2	20	2	20	ns	5
t_{CDD}	\overline{CAS} to D_{IN} Delay Time	20	—	20	—	ns	6
t_{OFF}	Output Buffer Turn-off delay	2	20	2	20	ns	

1. Measured with the specified current load and 100pF.
2. Access time is determined by the latter of t_{RAC} , t_{CAC} , t_{CPA} , t_{AA} , t_{OEA} .
3. Either t_{RHC} or t_{RRH} must be satisfied.
4. This timing parameter is not applicable to this product, but applies to a related product in this family.
5. t_{OFF} (max) and t_{OEZ} (max) define the time at which the output achieves the open circuit condition and is not referenced to output voltage levels.
6. Either t_{CDD} or t_{ODD} must be satisfied.

Fast Page Mode Cycle

Symbol	Parameter	-60		-70		Unit	Notes
		Min	Max	Min	Max		
t_{PC}	Fast Page Mode Cycle Time	40	—	45	—	ns	
t_{RASP}	Fast Page Mode \overline{RAS} Pulse Width	60	100K	70	100K	ns	
t_{CPRH}	\overline{RAS} Hold Time from \overline{CAS} Precharge	40	—	45	—	ns	
t_{CPA}	Access Time from \overline{CAS} Precharge	—	40	—	45	ns	1, 2

1. Measured with the specified current load and 100pF.
2. Access time is determined by the latter of t_{RAC} , t_{CAC} , t_{CPA} , t_{AA} , t_{OEA} .

Read-Modify-Write Cycle

Symbol	Parameter	-60		-70		Unit	Notes
		Min	Max	Min	Max		
t_{RWC}	Read-Modify-Write Cycle Time	158	—	188	—	ns	
t_{RWD}	\overline{RAS} to \overline{WE} Delay Time	83	—	98	—	ns	1
t_{CWD}	\overline{CAS} to \overline{WE} Delay Time	45	—	55	—	ns	1
t_{AWD}	Column Address to \overline{WE} Delay Time	58	—	68	—	ns	1
t_{OEH}	\overline{OE} Command Hold Time	15	—	15	—	ns	

1. t_{WCS} , t_{RWD} , t_{CWD} , t_{AWD} , and t_{CPW} are not restrictive parameters. They are included in the data sheet as electrical characteristics only. If $t_{WCS} \geq t_{WCS}(\text{min.})$, the entire cycle is an early write cycle and the data pin will remain open circuit (high impedance) through the entire cycle; If $t_{RWD} \geq t_{RWD}(\text{min.})$, $t_{CWD} \geq t_{CWD}(\text{min.})$, $t_{AWD} \geq t_{AWD}(\text{min.})$ and $t_{CPW} \geq t_{CPW}(\text{min.})$ (Fast Page Mode), the cycle is a Read-Modify-Write cycle and the data will contain read from the selected cell; If neither of the above sets of conditions are met, the condition of the data (at access time) is indeterminate.

Fast Page Mode Read-Modify-Write Cycle

Symbol	Parameter	-60		-70		Unit
		Min	Max	Min	Max	
t_{PRWC}	Fast Page Mode Read-Modify-Write Cycle Time	83	—	98	—	ns
t_{CPW}	\overline{WE} Delay time from \overline{CAS} Precharge	63	—	73	—	ns

Refresh Cycle

Symbol	Parameter	-60		-70		Unit	Notes
		Min	Max	Min	Max		
t _{CHR}	CAS Hold Time (CAS before RAS Refresh Cycle)	8	—	8	—	ns	
t _{CSR}	CAS Setup Time (CAS before RAS Refresh Cycle)	14	—	14	—	ns	
t _{WRP}	WE Setup Time (CAS before RAS Refresh Cycle)	15	—	15	—	ns	
t _{WRH}	WE Hold Time (CAS before RAS Refresh Cycle)	8	—	8	—	ns	
t _{RPC}	RAS Precharge to CAS Hold Time	3	—	3	—	ns	
t _{REF}	Refresh Period	—	32	—	32	ms	1

1. 2048 refreshes are required every 64ms.

Presence Detect Read Cycle

Symbol	Parameter	-60		-70		Unit	Notes
		Min	Max	Min	Max		
t _{PD}	PDE to Valid Presence Detect Data	—	10	—	10	ns	1
t _{PDOFF}	PDE Inactive to Presence Detects Inactive	0	10	0	10	ns	2

1. Measured with the specified current load and 100pF.
2. t_{PDOFF(max)} defines the time at which the output achieves the open circuit condition and is not referenced to output voltage levels.

Read Cycle

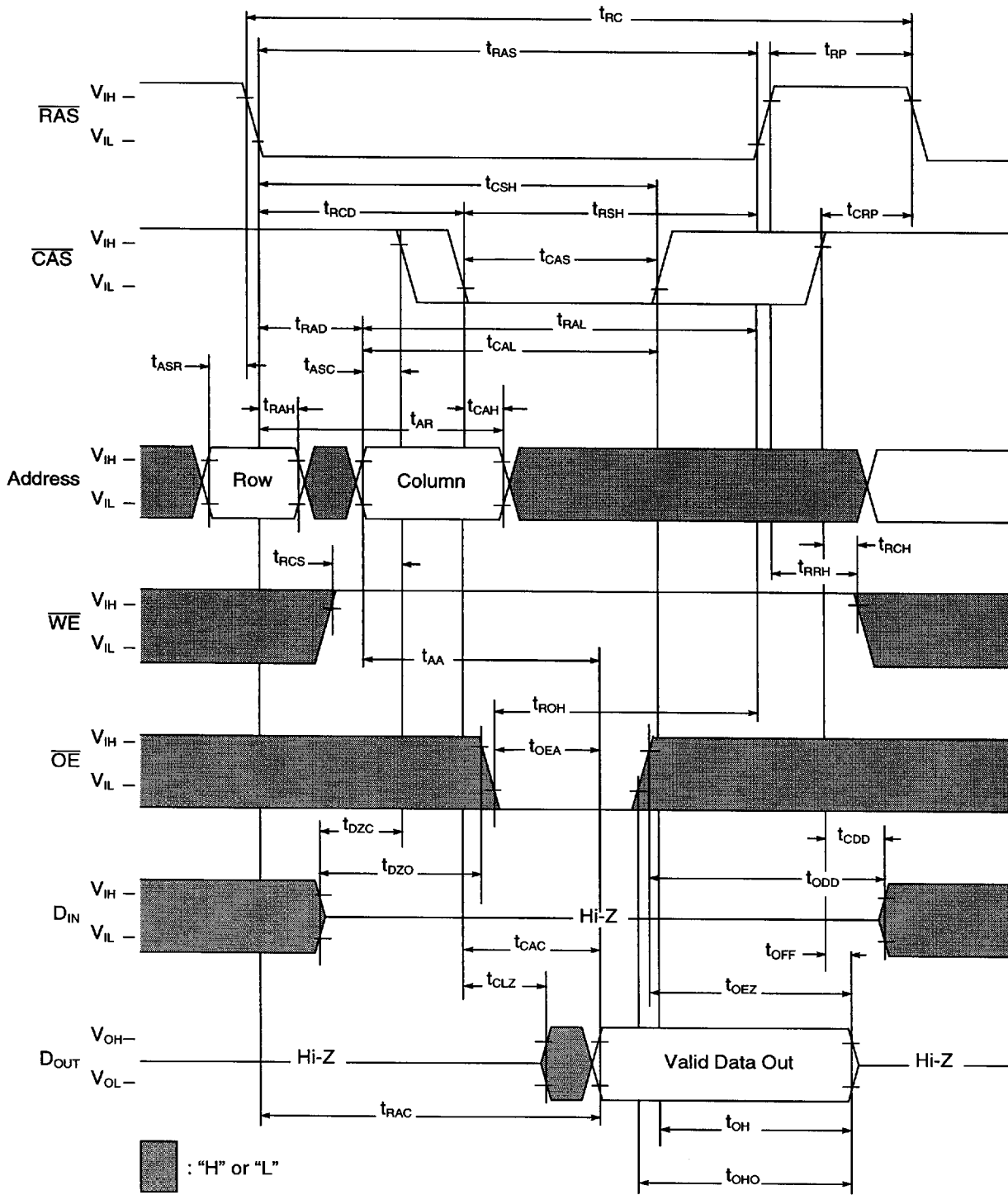

Write Cycle (Early Write)

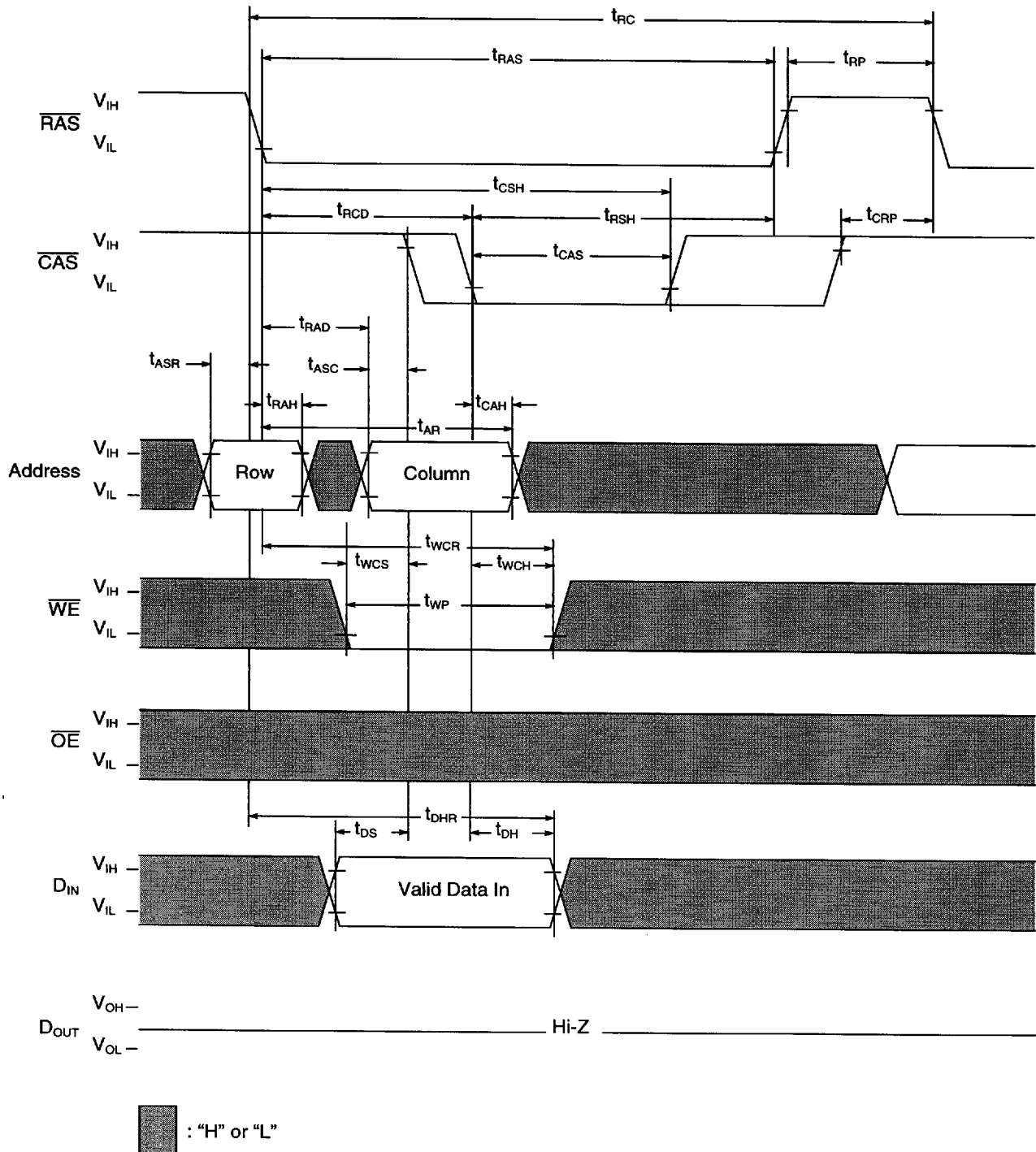

Fast Page Mode Write Cycle

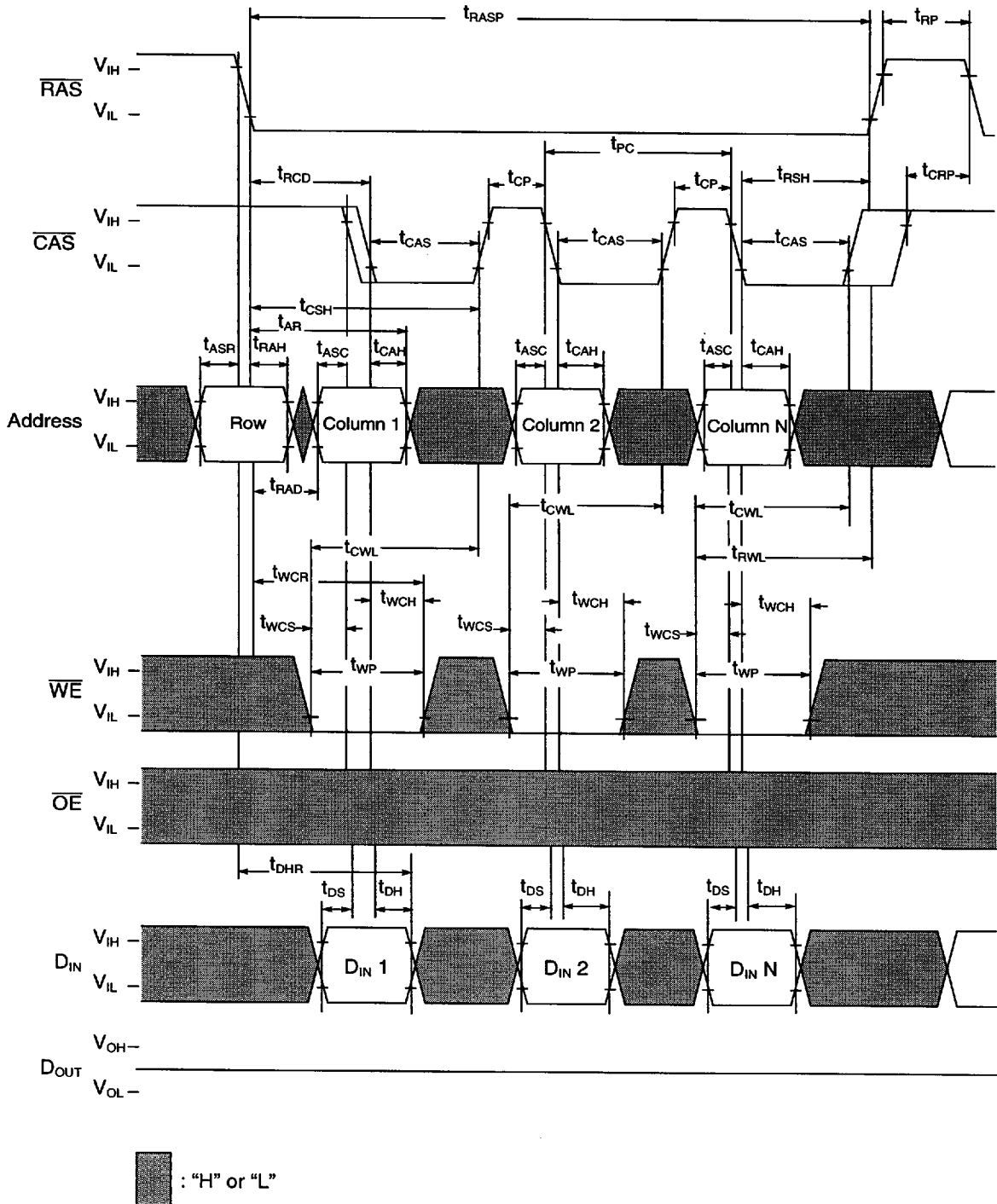

Fast Page Mode Read-Modify-Write Cycle

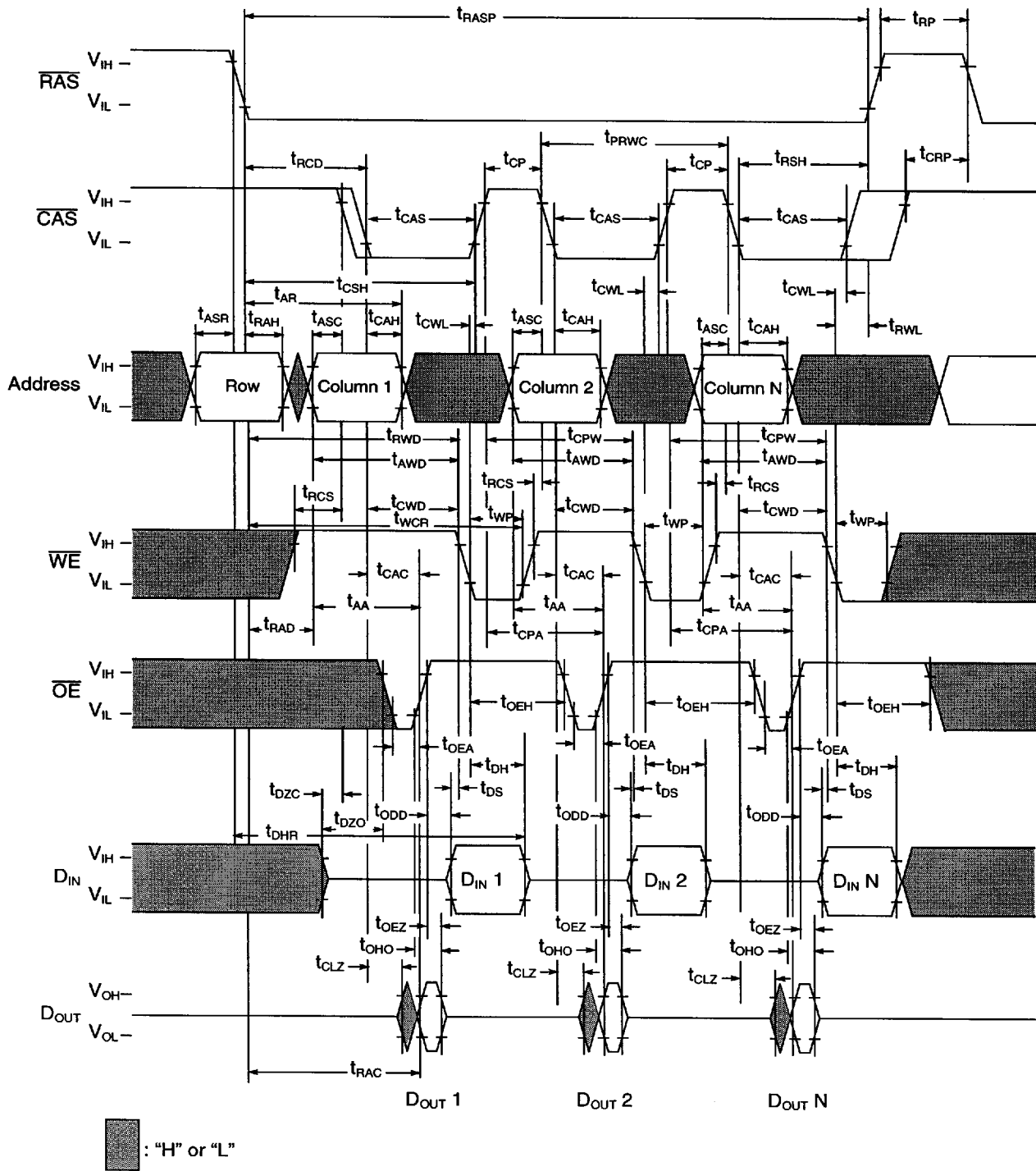

RAS Only Refresh Cycle

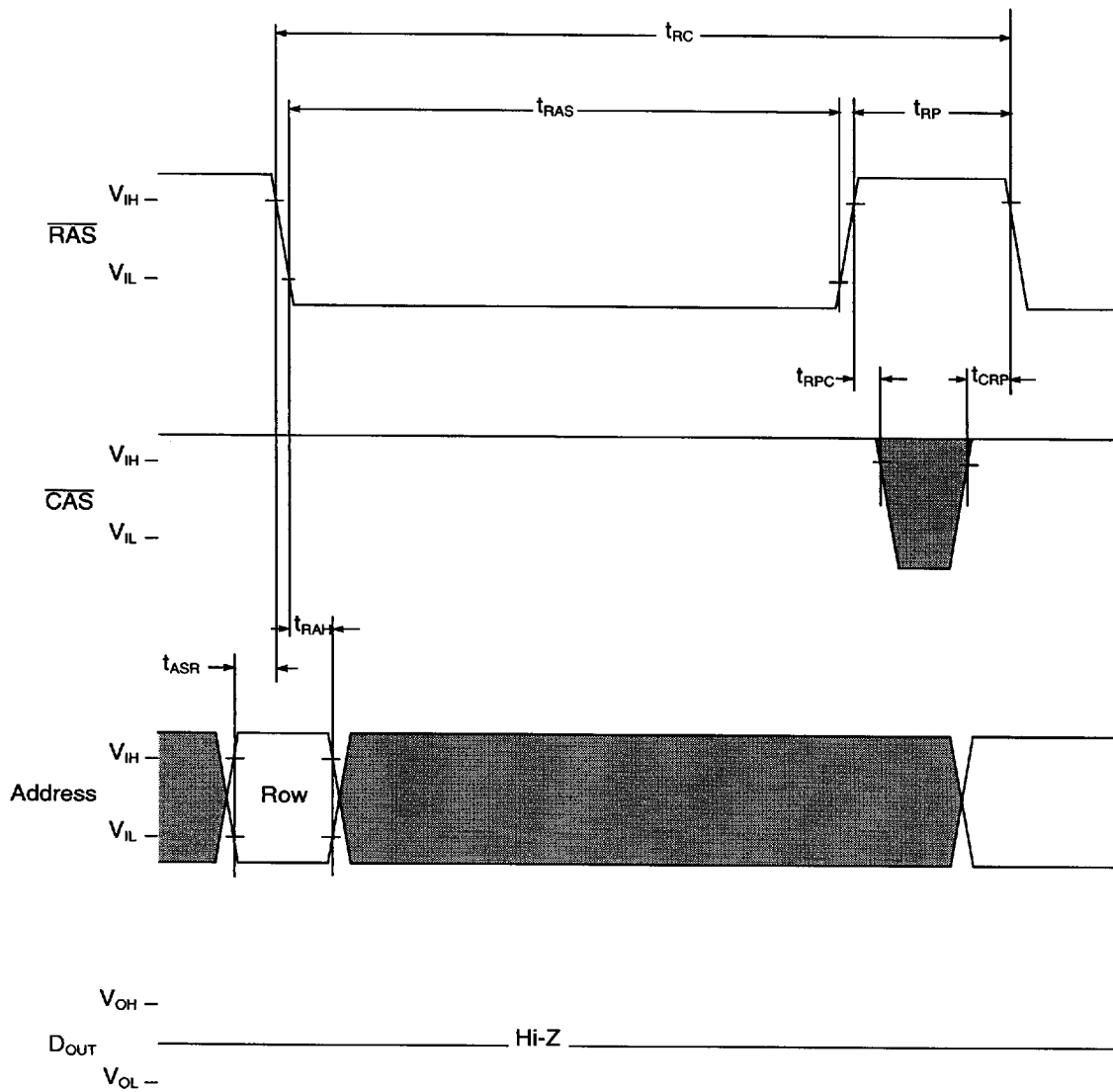

■ : "H" or "L"

Note: $\overline{\text{WE}}$, $\overline{\text{OE}}$, D_{IN} are "H" or "L"

CAS Before RAS Refresh Cycle

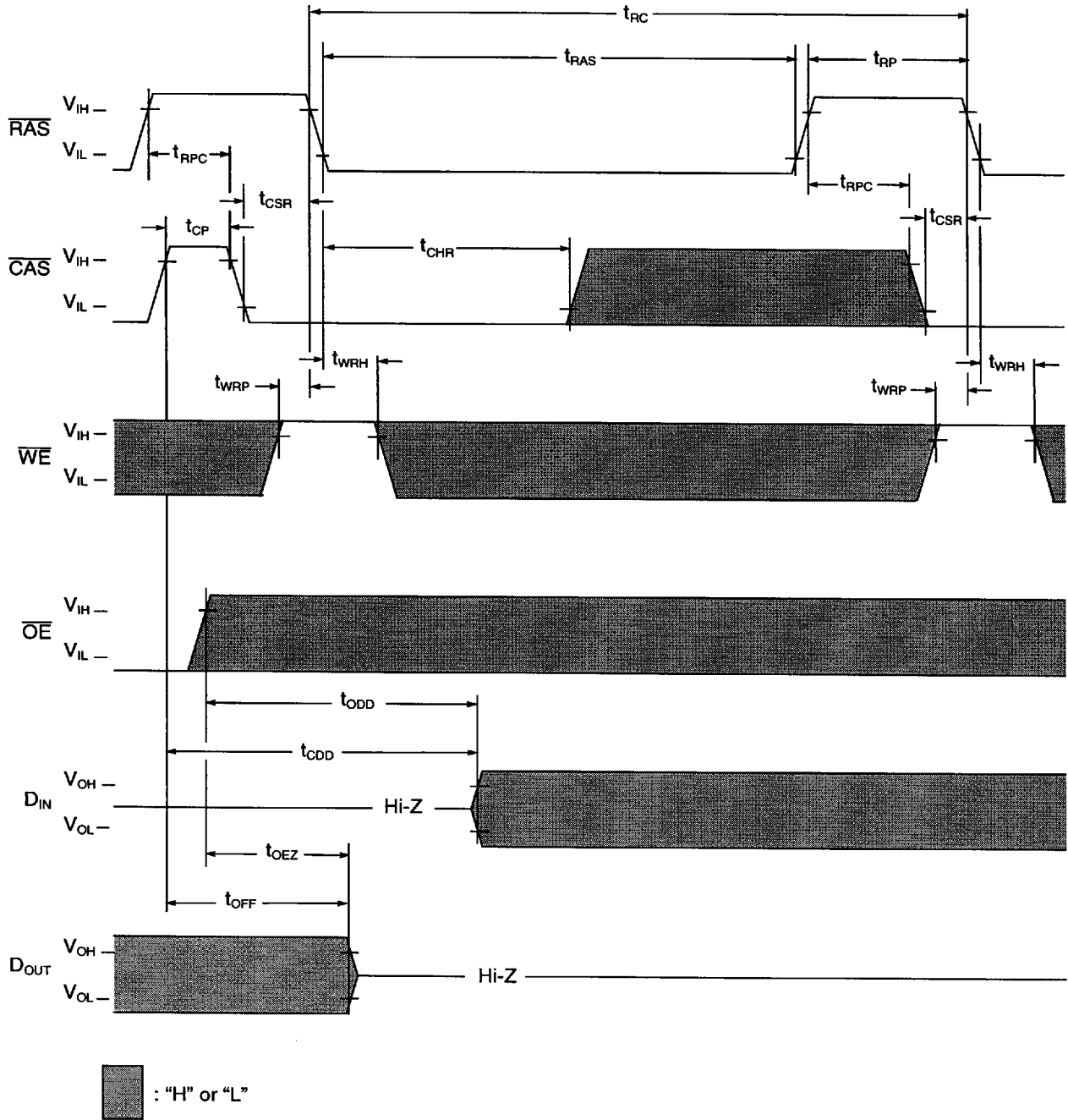

NOTE: Address is "H" or "L"

Hidden Refresh Cycle (Write)

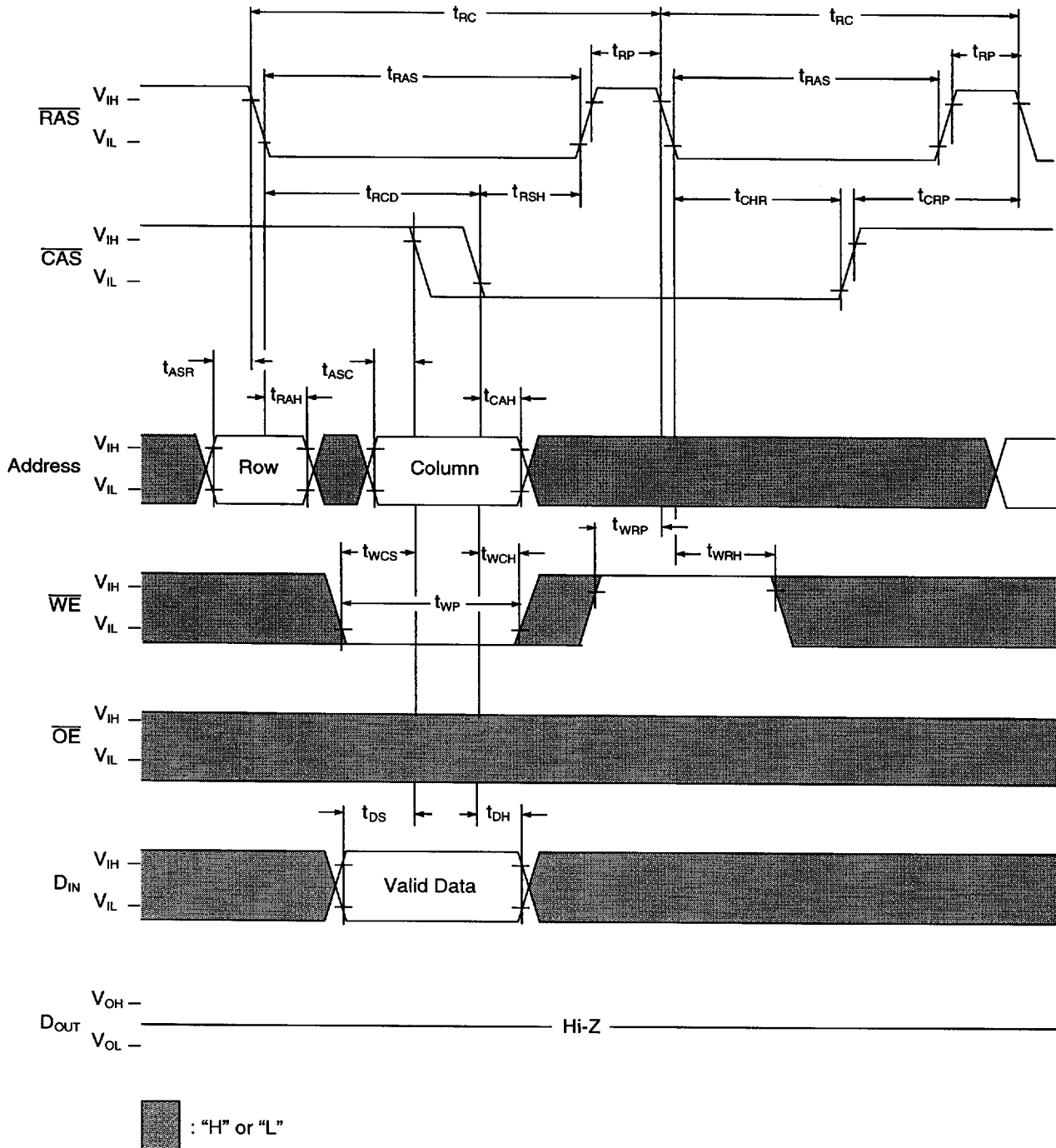

Presence Detect Read Cycle

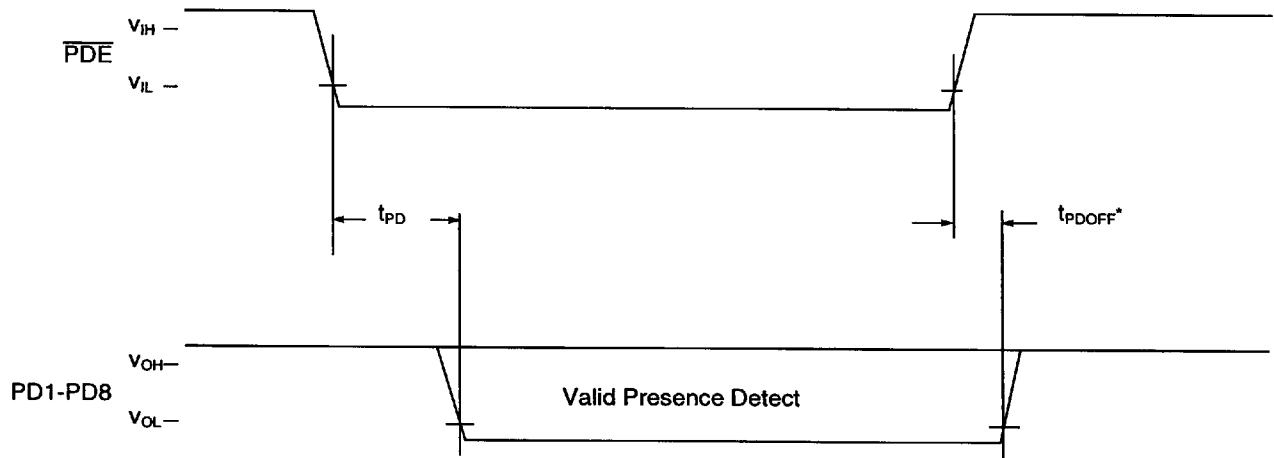

*PD pins must be pulled high at next level of assembly

Layout Drawing 3.3V/5.0V

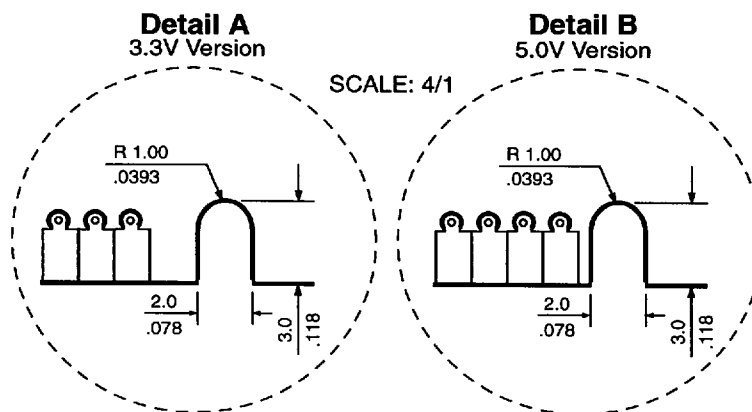
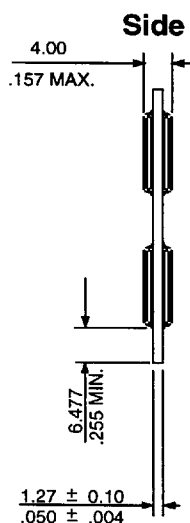
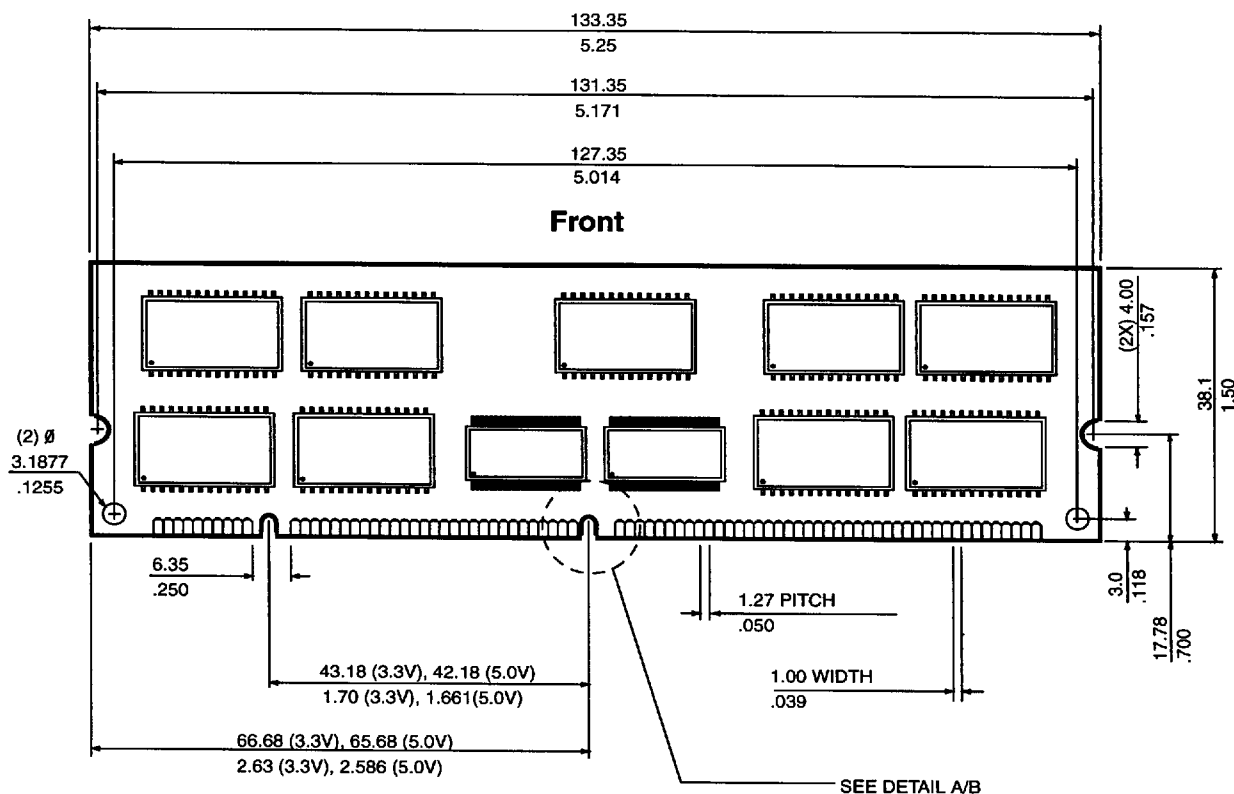

Note: All dimensions are typical unless otherwise stated. Millimeters
Inches



Revision Log

Rev	Contents of Modification
3/96	Initial Release.
5/96	Updated ordering information