

2SC4664
(TP8V20FS)

8A NPN

OUTLINE DIMENSIONS

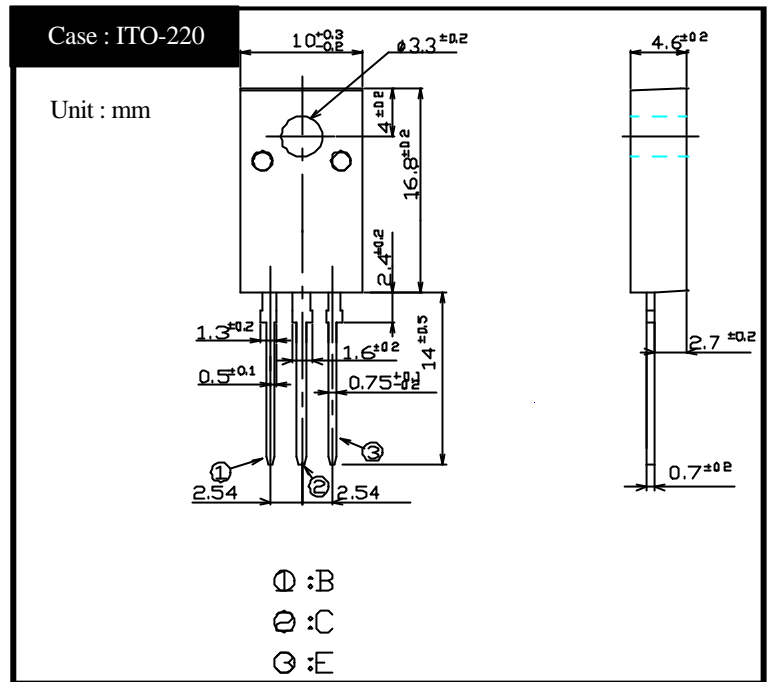

RATINGS

Absolute Maximum Ratings

Item	Symbol	Conditions	Ratings	Unit
Storage Temperature	T _{stg}		-55 ~ 150	
Junction Temperature	T _j		150	
Collector to Base Voltage	V _{CB0}		250	V
Collector to Emitter Voltage	V _{CEO}		200	V
Emitter to Base Voltage	V _{EBO}		7	V
Collector Current DC	I _C		8	A
Collector Current Peak	I _{CP}		16	
Base Current DC	I _B		3	A
Base Current Peak	I _{BP}		6	
Total Transistor Dissipation	P _T	T _C = 25	30	W
Dielectric Strength	V _{dis}	Terminals to case, AC 1 minute	2	kV
Mounting Torque	TOR	(Recommended torque : 0.3N·m)	0.5	N·m

Electrical Characteristics (T_C=25)

Item	Symbol	Conditions	Ratings	Unit
Collector to Emitter Sustaining Voltage	V _{CEO(sus)}	I _C = 0.1A	Min 200	V
Collector Cutoff Current	I _{CB0}	At rated Voltage	Max 0.1	mA
			Max 0.1	
Emitter Cutoff Current	I _{EBO}	At rated Voltage	Max 0.1	mA
DC Current Gain	h _{FE}	V _{CE} = 2V, I _C = 4A	10 ~ 25 ^{*1}	
			h _{FEL}	
Collector to Emitter Saturation Voltage	V _{CE(sat)}	I _C = 4A	Max 1.0	V
Base to Emitter Saturation Voltage	V _{BE(sat)}	I _B = 0.8A	Max 1.5	V
Thermal Resistance	j _C	Junction to case	Max 4.17	/W
Transition Frequency	f _T	V _{CE} = 10V, I _C = 0.8A	TYP 13	MHz
Turn on Time	ton	I _C = 4A	Max 0.3	μs
Storage Time	ts	I _{B1} = 0.8A, I _{B2} = 1.6A	Max 1.0	
Fall Time	tf	R _L = 37.5 , V _{BB2} = 4V	Max 0.1	

2SC4664 $h_{FE} - I_C$

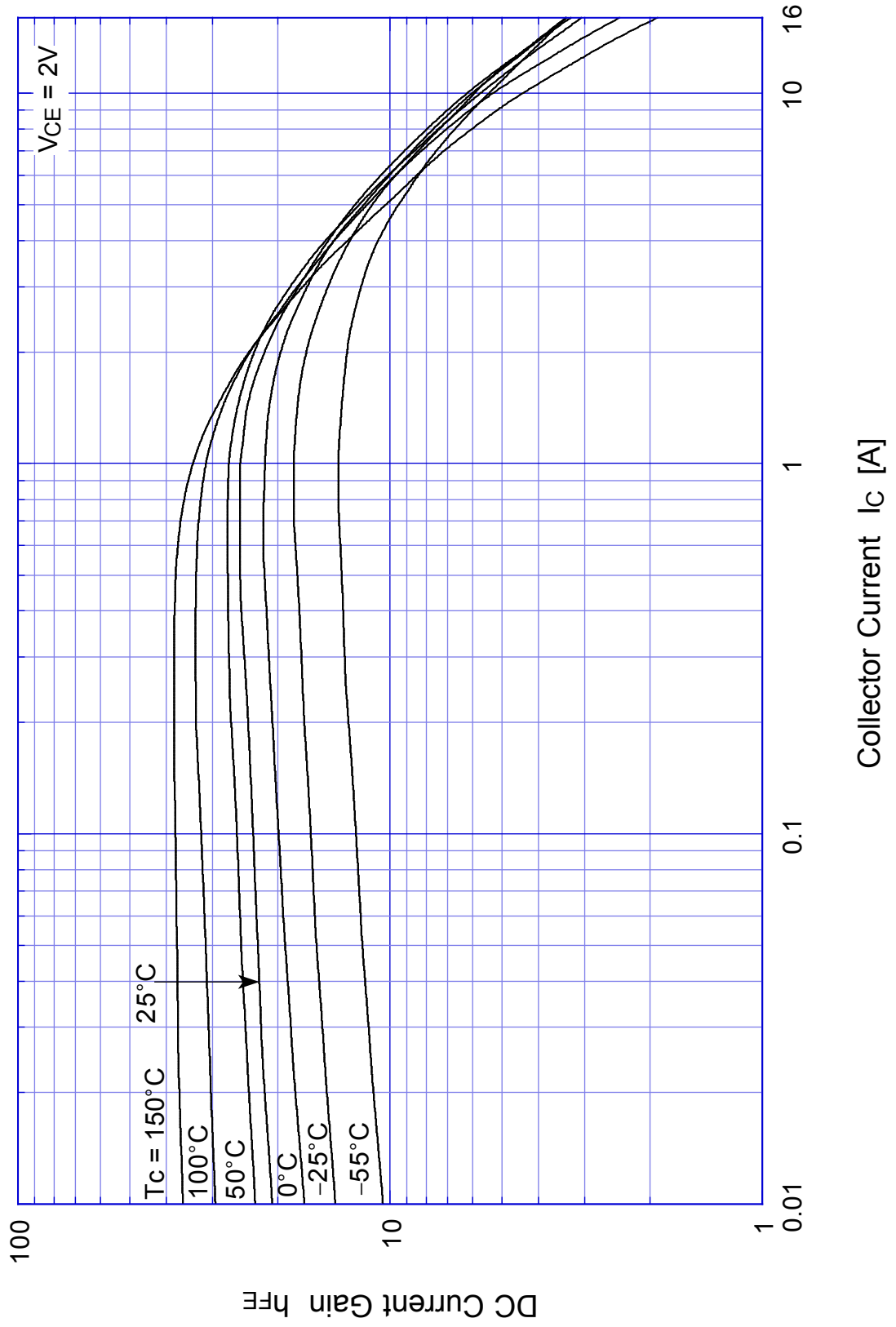

2SC4664 Saturation Voltage

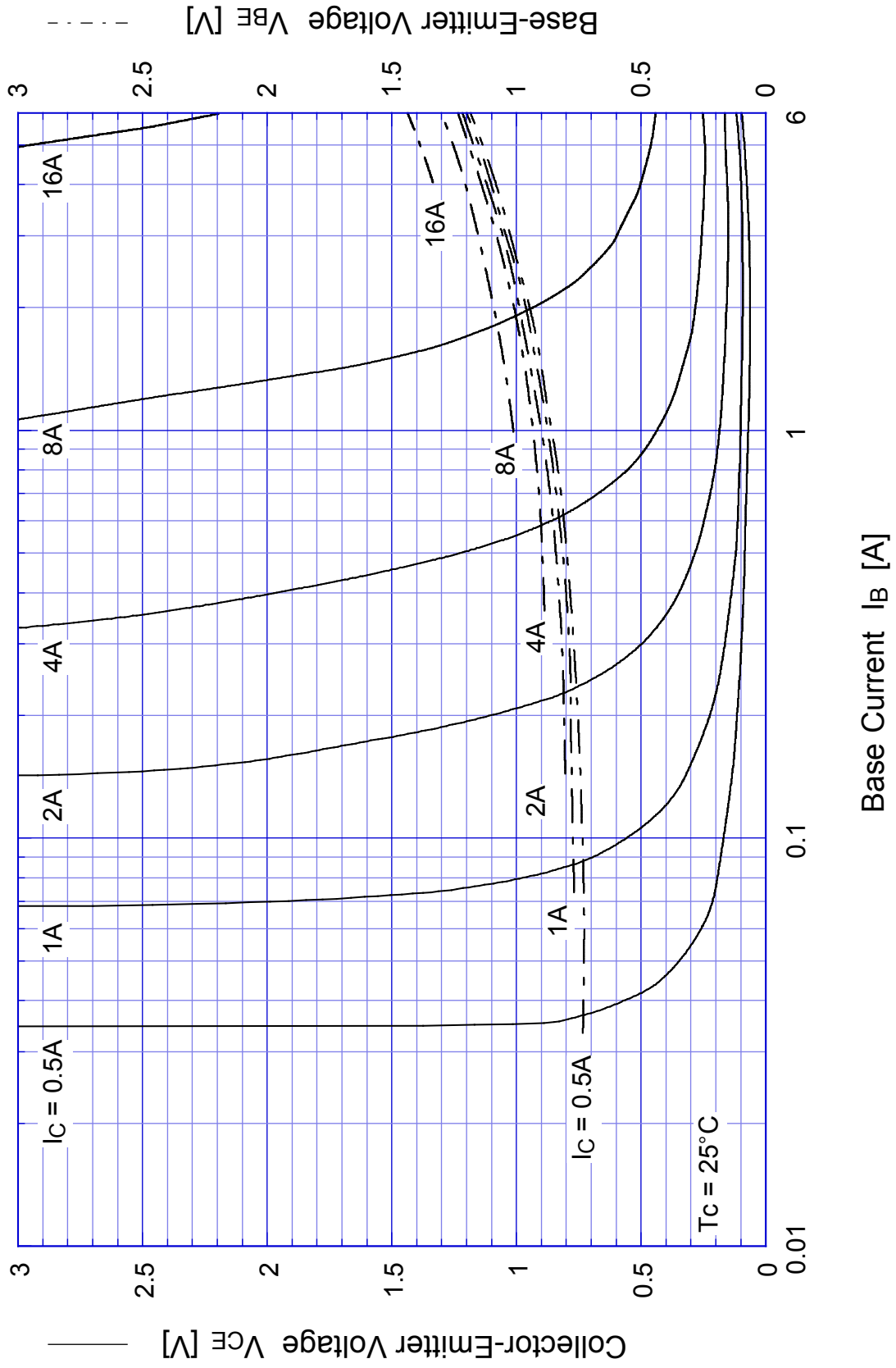

2SC4664

Switching Time - I_C

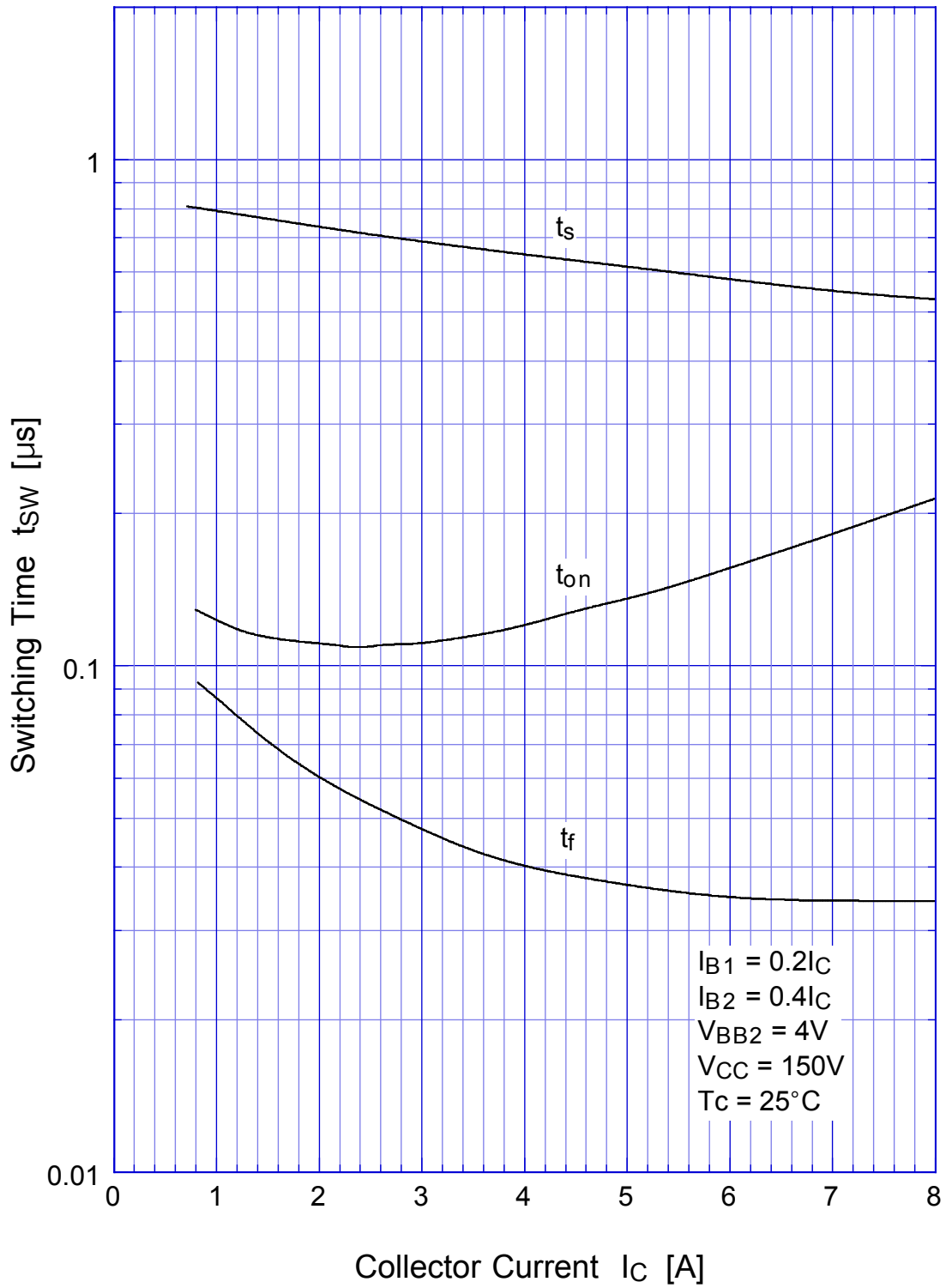

2SC4664

Switching Time - Tc

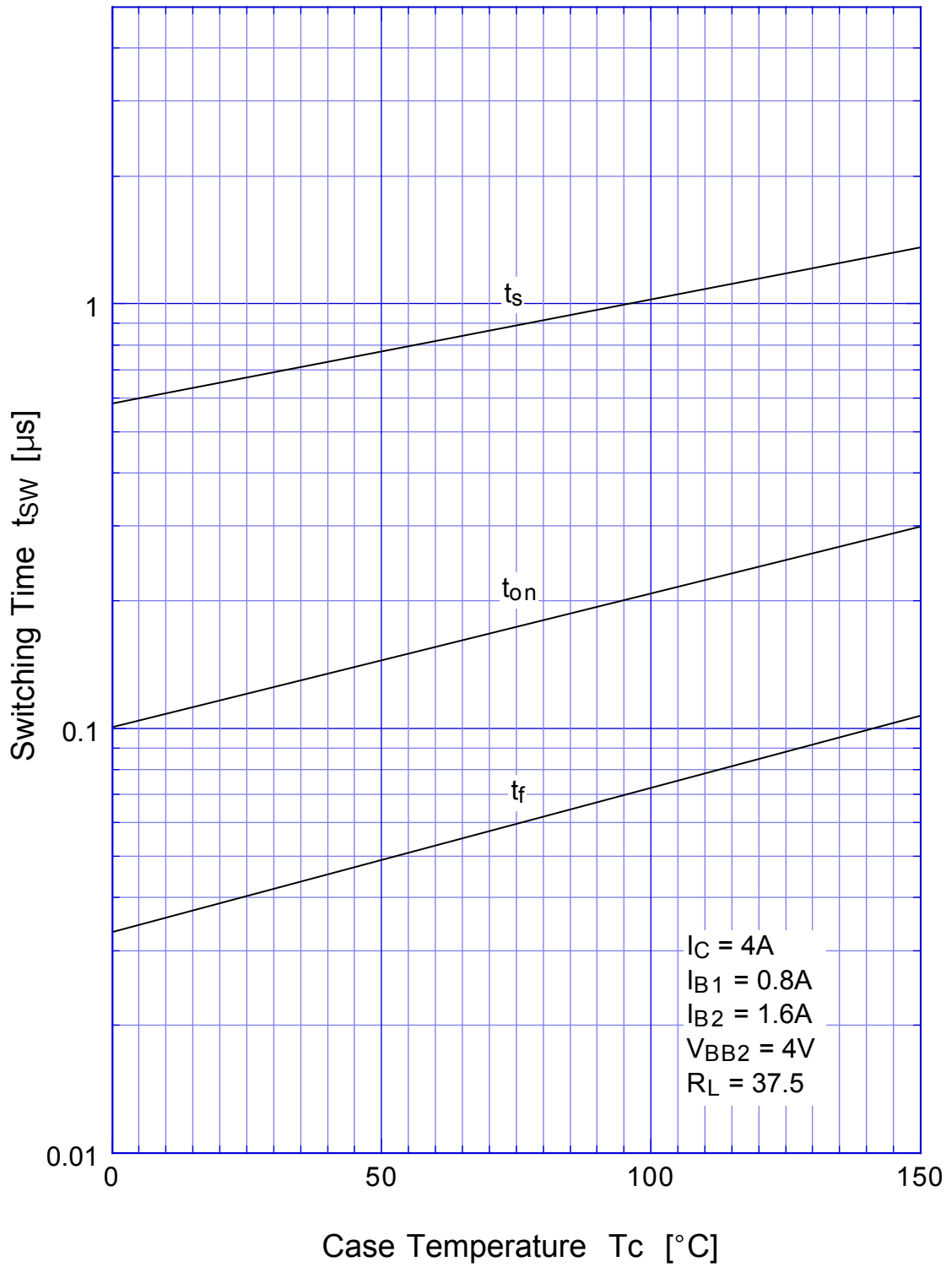

2SC4664

Forward Bias SOA

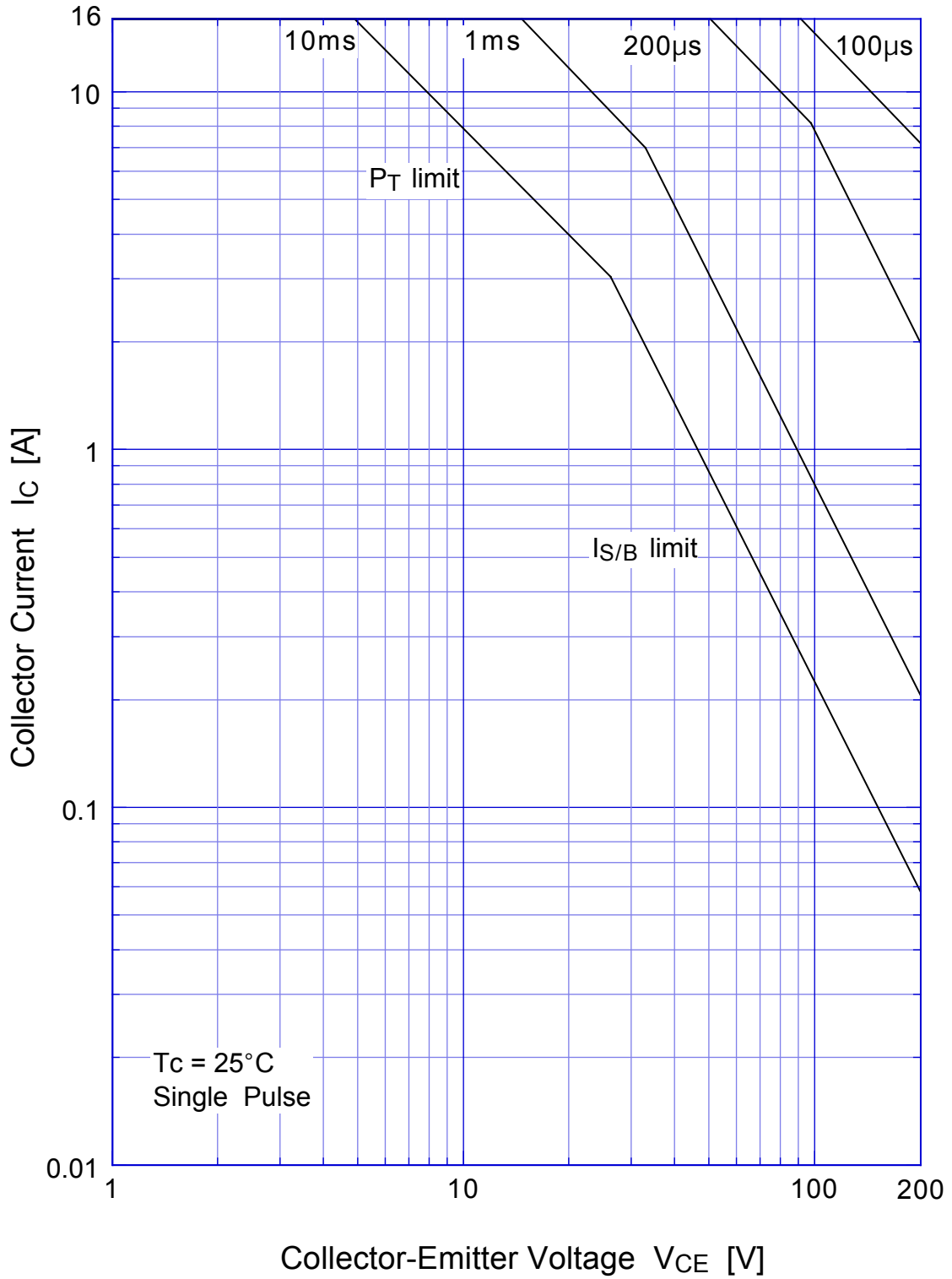

2SC4664 Collector Current Derating

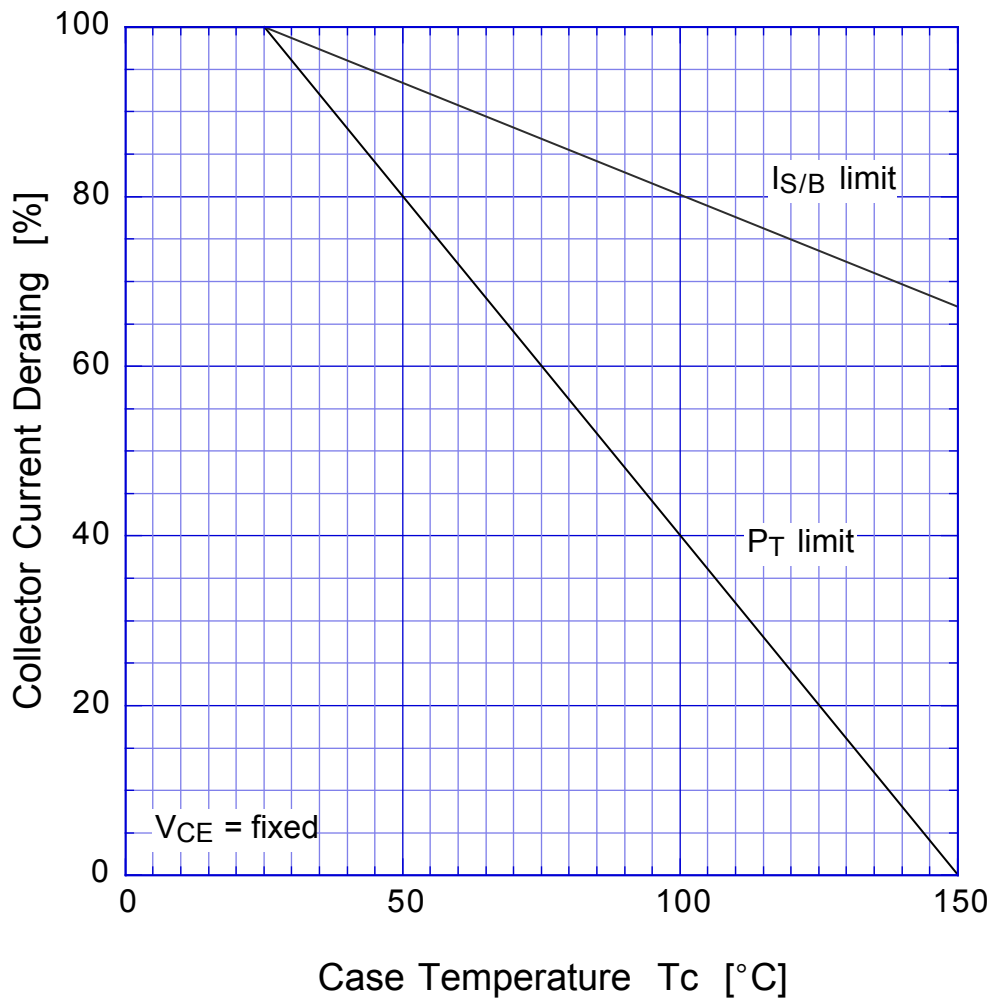

2SC4664

Reverse Bias SOA

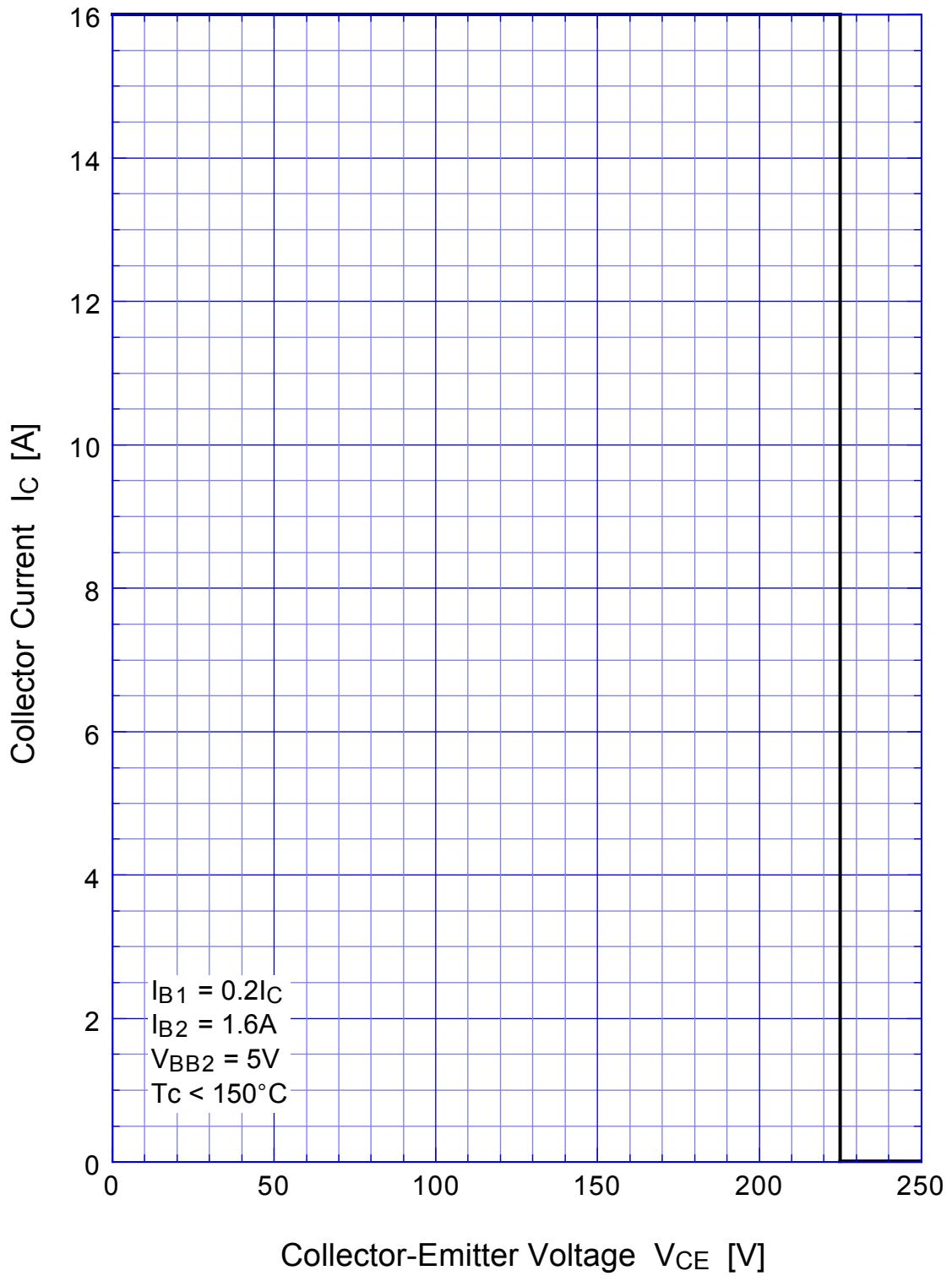

2SC4664 Transient Thermal Impedance

