



# SLC100

## 40 Amp Single Output Quarter Brick DC/DC Converter



The SLC100 Series is a 40 Amp single output, low-profile DC-DC converter in an industry standard package of 2.28" x 1.45" x 0.40". The SLC100 uses unique proprietary technologies to deliver ultra-high efficiencies and excellent thermal performance. It includes extensive control and protection features for maximum flexibility and provides a versatile solution for a whole range of

applications with its input voltage range of 36-75 VDC and output voltages between 1.0VDC and 12.0VDC.

The power dissipation of the SLC100 series is so low that a heat sink is not required. Thermal derating curves are provided indicating maximum allowable output current versus airflow and ambient temperature. The product features fast dynamic response characteristics and low

output ripple critical for low voltage applications. SLC DC-DC converter modules are certified to UL/CUL 60950, and VDE to EN60950. It meets CISPR22/EN55022/FCC15J Class B specs for EMI levels with external filtering.

This high quality and highly reliable product is competitively priced and an ideal solution for distributed power, telecoms and datacom applications.

**OBSOLETE PRODUCT**  
Contact factory for replacement model

- Industry Standard Footprint & Size - 2.28" x 1.45"
- High Efficiency
- Wide Input Voltage Range: 36 – 75VDC
- Output Voltages: 1.0V, 1.2 V, 1.5V, 1.8V, 2.0V, 2.5V, 3.3V, 5.0V & 12V
- Output Voltage Trim Function
- Remote Sense for output compensation
- Remote ON/OFF control referenced to input side (Positive or Negative Logic)
- Output Current Limit
- No Minimum Load Requirement
- SMD Models with Position Perfect™ Interconnects
- Isolation Voltage of 2000 VDC
- Fixed Frequency Operation
- UL/CUL 60950 recognized (US & Canada), basic insulation rating
- Meets TNV-SELV Isolation Requirements
- Meets Conducted Emissions Requirements of FCC Class B and EN55022 Class B with External Filter
- No Heatsink Required
- Thermal Shutdown
- Input Undervoltage Lockout

### PRODUCT SELECTION CHART

MODEL	NOMINAL INPUT VOLTAGE (Vdc)	RATED OUTPUT VOLTAGE (VDC)	OUTPUT CURRENT		INPUT CURRENT AT RATED LOAD (A) (48V <sub>in</sub> )	EFFICIENCY (%) TYPICAL
			MIN LOAD(A)	RATED OUTPUT (A) <sup>1</sup>		
SLC100	48	1.0	0.0	40	TBD	TBD
SLC100	48	1.2	0.0	40	1.80	80
SLC100	48	1.5	0.0	40	2.20	82
SLC100	48	1.8	0.0	40	TBD	TBD
SLC100	48	2.0	0.0	40	TBD	TBD
SLC100	48	2.5	0.0	40	TBD	TBD
SLC100	48	3.3	0.0	30	TBD	TBD
SLC100	48	5.0	0.0	20	TBD	TBD
SLC100	48	12.0	0.0	8.3	TBD	TBD

\* Note 1: Maximum output current for SMD Models is 25A.

## ABSOLUTE MAXIMUM RATINGS, ALL MODELS

PARAMETER	CONDITIONS	MIN	TYP	MAX	UNITS
Input Voltage-Operating	Continuous			75	V <sub>DC</sub>
Input Voltage-Operating	Transient (100 mS)			TBD	V <sub>DC</sub>
Operating Ambient Temperature		-40		+100	°C
Storage Temperature		-40		+125	°C
Output Short Circuit Duration			Continuous		
Lead Temperature (Soldering, 10 sec max)				+300	°C

## COMMON ELECTRICAL SPECIFICATIONS, ALL MODELS

Specifications are at T<sub>A</sub> = +25°C, Airflow = 300LFM (1.5m/s) at nominal input voltage unless otherwise specified.

PARAMETER	CONDITIONS	MIN	TYP	MAX	UNITS
<b>INPUT</b>					
Voltage Range		36	48	75	V <sub>DC</sub>
<b>ISOLATION</b>					
Input/Output Isolation Voltage		2000			V <sub>DC</sub>
Capacitance	Input to Output		2000		pF
Resistance	Input to Output	10			MΩ
<b>FEATURES</b>					
Turn On Time	Output to within 1% of V <sub>nom</sub>				5.00 mS
Remote Sense Compensation				5	% of V <sub>NOM</sub>
Output Voltage Trim Range		-10		+10	% of V <sub>NOM</sub>
Output Over Voltage Protection		+120		+140	% of V <sub>NOM</sub>
Over Temperature Shutdown					
Shutdown			TBD		°C
Turn On			TBD		°C
Input Under Voltage Protection					
Turn Off		31.50		32.50	V <sub>DC</sub>
Turn Off		32.50		33.70	V <sub>DC</sub>
Lockout Hysteresis Voltage		0		2.2	V <sub>DC</sub>
ON/OFF Logic Function					
Logic Low I <sub>on/off</sub>					mA
Logic Low V <sub>on/off</sub>				TBD	V <sub>DC</sub>
Logic High I <sub>on/off</sub>				0.8	μA
Logic High V <sub>on/off</sub>			Open Collector	TBD	V <sub>DC</sub>
<b>GENERAL</b>					
Switching Frequency		TBD		200	KHz
MTTF (per Telcordia TR-NWT-000332)			TBD		Hrs

# MECHANICAL (THROUGH HOLE)

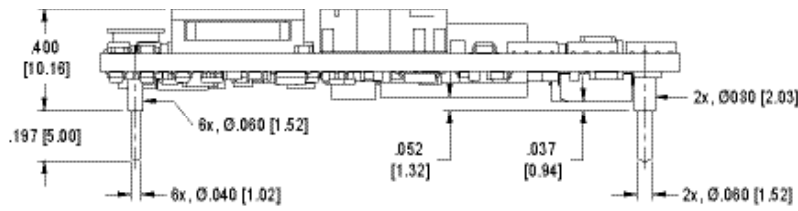

General Tolerance: ±.015

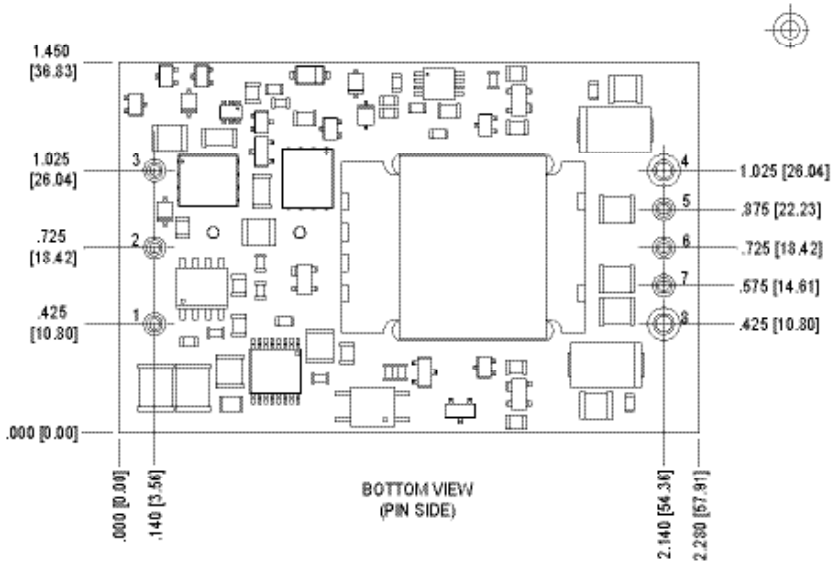

PIN FUNCTIONS	
1	+Vin
2	Remote On/Off
3	-Vin
4	-Vout
5	- Sense
6	Trim
7	+ Sense
8	+Vout

**NOTES:**  
 General Tolerance; ±.015  
 Pin Locations/Diameters: ±.005  
 Dimensions are in inches [Millimeters]  
 Pin material: Copper  
 Pin Finish: Matte Tin over Nickel  
 Converter weight: [30.8g]

UL/TUV Standards require a clearance greater than 0.06" between input and output for Basic insulation. This should be considered if copper traces are used on the top side of the board under the converter unit. Ferrite cores are considered part of the input/primary circuit.

# MECHANICAL (SMT)

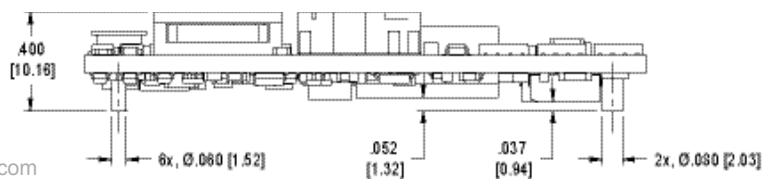

General Tolerance: ±.015

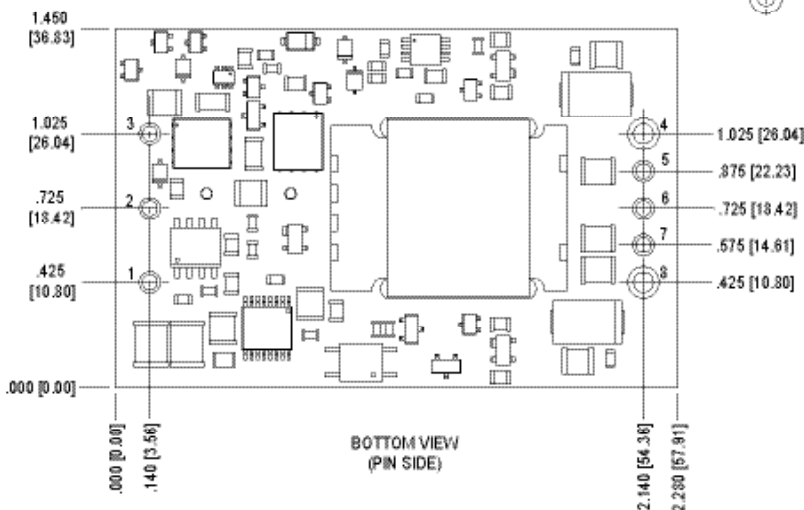

Interconnect FUNCTIONS	
1	+Vin
2	Remote On/Off
3	-Vin
4	-Vout
5	- Sense
6	Trim
7	+ Sense
8	+Vout

**NOTES:**  
 General Tolerance; ±.015  
 Interconnect Locations/Diameters: ±.005  
 Dimensions are in inches [Millimeters]  
 Pin material: Copper  
 Pin Finish: Matte Tin over Nickel  
 Converter weight: [30.8g]

UL/TUV Standards require a clearance greater than 0.06" between input and output for Basic insulation. This should be considered if copper traces are used on the top side of the board under the converter unit. Ferrite cores are considered part of the input/primary circuit.

Interconnect co-planarity within 0.004"

## ORDERING INFORMATION

MODEL NUMBER	Vout (Vdc)	PINOUT	LOGIC
SLC100 - 1	1.0	Through Hole	Positive
SLC100 - 2	1.2	Through Hole	Positive
SLC100 - 3	1.5	Through Hole	Positive
SLC100 - 4	1.8	Through Hole	Positive
SLC100 - 5	2.0	Through Hole	Positive
SLC100 - 6	2.5	Through Hole	Positive
SLC100 - 7	3.3	Through Hole	Positive
SLC100 - 8	5.0	Through Hole	Positive
SCL100 - 9	12.0	Through Hole	Positive
SLC100 - 10	1.0	SMD	Positive
SLC100 - 11	1.2	SMD	Positive
SLC100 - 12	1.5	SMD	Positive
SLC100 - 13	1.8	SMD	Positive
SLC100 - 14	2.0	SMD	Positive
SLC100 - 15	2.5	SMD	Positive
SLC100 - 16	3.3	SMD	Positive
SLC100 - 17	5.0	SMD	Positive
SLC100 - 18	12.0	SMD	Positive

MODEL NUMBER	Vout (Vdc)	PINOUT	LOGIC
SLC100 - 19	1.0	Through Hole	Negative
SLC100 - 20	1.2	Through Hole	Negative
SLC100 - 21	1.5	Through Hole	Negative
SLC100 - 22	1.8	Through Hole	Negative
SLC100 - 23	2.0	Through Hole	Negative
SLC100 - 24	2.5	Through Hole	Negative
SLC100 - 25	3.3	Through Hole	Negative
SLC100 - 26	5.0	Through Hole	Negative
SCL100 - 27	12.0	Through Hole	Negative
SLC100 - 28	1.0	SMD	Negative
SLC100 - 29	1.2	SMD	Negative
SLC100 - 30	1.5	SMD	Negative
SLC100 - 31	1.8	SMD	Negative
SLC100 - 32	2.0	SMD	Negative
SLC100 - 33	2.5	SMD	Negative
SLC100 - 34	3.3	SMD	Negative
SLC100 - 35	5.0	SMD	Negative
SLC100 - 36	12.0	SMD	Negative

### Remote Sense

The remote sense feature of the SLC100 can be used to compensate for voltage drops in the output power lines by sensing output voltage directly at the point of load. To enable this feature, connect the +Sense and -Sense pins to the +Vout and -Vout pins, respectively, at the point in the circuit where the tightest regulation is required (**Figure 1**). The sense leads conduct very little current compared with the power leads and therefore provide a more accurate indication of load voltage for regulation purposes. This enables the converter to increase (or decrease) its output voltage to compensate for any load distribution losses, allowing for a more precise load voltage. Refer to the product data sheet for the maximum output voltage compensation range of

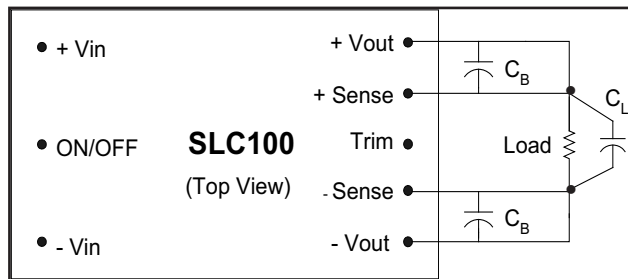

Figure 1 – Remote Sensing

www.DataSheet4U.com

In general, the line resistance, or load drop, between the output pins of the converter and load should be minimized. Using remote sense, a large line resistance, with a regulated load voltage, will result in a higher output voltage at the output of the DC/DC Converter. To prevent exceeding the converter’s output power limits, a higher output voltage will require a reduction in the maximum allowable output current in accordance with the voltage/current power relationship. To minimize the line resistance between the converter and the load, the converter should be placed as close to the load as possible. Line resistance can further be decreased by using heavy gauge wire or by increasing the cross sectional area of the PC board traces.

When using remote sense with dynamic loads, the transient response at the point of load may be limited by the inductance present in the power lines. Severe load steps may require the addition of a capacitor  $C_L$  across the output lines. When the load demands an immediate increase in load current, this capacitor helps to supply a portion of the current and reduces the burden on the converter.

When the load is physically distanced from the converter, the inductance of the power leads, and any bypass conductance at the load, can result in increased phase shift in the converter’s feedback loop, causing instability. This situation can be eliminated by inserting bypass capacitors ( $C_B$ ) from the outputs to the sense leads directly at the output pins. These capacitors decouple any AC on the power lines and assure that only the DC voltage is sensed.

**If remote sensing is not desired then +Sense and -Sense must be tied to their respective outputs for proper operation.**

### Output Voltage Trim

The SLC100’s output voltage may be adjusted high or low by an amount indicated on the product data sheet. As shown in **Figure 2**, to raise the converter’s output voltage a resistor must be placed between the Trim pin and +Vout pin.

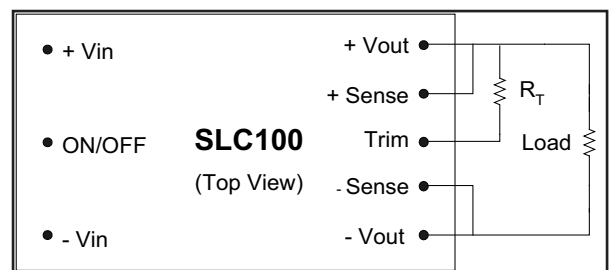

Figure 2 – Trim Up Circuit

To lower the converter output voltage a resistor must be placed between the Trim pin and -Vout pin as shown in Figure 3.

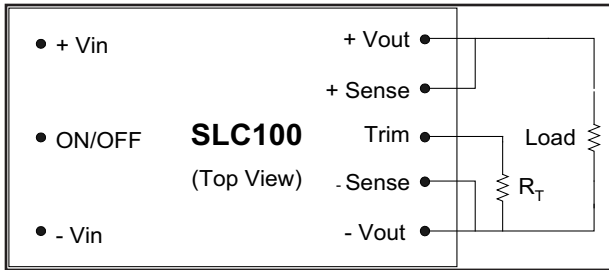

Figure 3 – Trim Down Circuit

The resistance value required to achieve the desired amount of positive/negative trim can be determined by referring to the trim table for each model. If trimming is not desired then the Trim pin may be left open.

In addition to the resistor values provided in the trim tables, the following equations can be used to calculate the required resistor value for a desired output voltage. These equations apply for the 1.5V and above models. For 1.2V models the trim tables must be used.

### Remote ON/OFF Control Function

The SLC100 is equipped with a primary ON/OFF pin used to remotely turn the converter on or off via a system signal. The input is TTL open-collector and/or FET open-drain compatible. For the positive logic model a system logic low signal will turn the unit off. For negative logic models a system logic high signal will turn the converter off. For negative logic models where no control signal will be used the ON/OFF pin should be connected directly to -Vin to ensure proper operation. For positive logic models where no control signal will be used the ON/OFF pin should be left open.

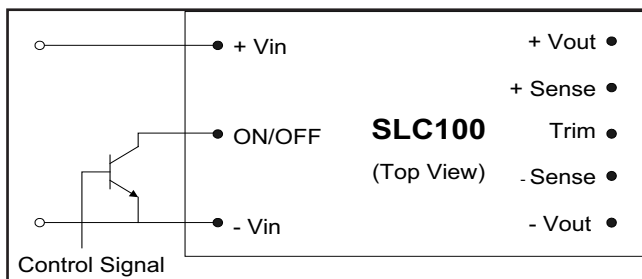

Figure 4 – Remote ON/OFF Control Circuit

## Protective Functions

### Temperature Shutdown

The over temperature shutdown feature of the SLC100 will cause the unit to shutdown at a typical pwb temperature of TBD. This protective feature is comprised of a thermistor in the units control loop. At a temperature of TBD this circuit will cause the PWM to go into an idle mode, resulting in no output from the converter and preventing damage to the converter components. When the temperature of the unit drops below TBD the fault condition will clear and the converter will resume normal operation. If the cause of the over temperature condition is not identified and corrected the unit will continue to cycle on and off indefinitely.

### Input Under-Voltage Shutdown

The nominal input voltage for the SLC100 is 48Vdc. Once turned on reducing the input voltage to 32.5 Vdc nominal will shut down the device. At an input voltage less than 32.5V the under-voltage sensing circuit will send a signal to the PWM causing it to go into idle mode. This will result in no output from the converter, protecting the unit from a high input current condition. When the input voltage returns to a level above 32.5V the unit will return to normal operation. The unit will typically turn on at an input voltage of 33.7V nominal as indicated on the Product Data Sheet. This is due to hysteresis designed into the protective circuit to prevent excessive cycling of the converter.

### Brick Wall Current Limiting

To protect against fault or short-circuit conditions on the output, each module is equipped with current-limiting circuitry designed to provide continuous protection. After reaching the current limit point (typically 20% above the rated output current), the voltage will range between its rated value and zero, depending upon the amount of overload. The unit will remain in operation continuously during this period down to a short-circuit condition. Once the short or overload has been eliminated, the output voltage will return to normal without cycling the input power.

### Output Over-Voltage Protection

The SLC100 has an output over voltage protection (OVP) circuit which monitors its own output voltage. If the output voltage of the converter exceeds between 120% and 140% of the nominal rating, the OVP circuit will shut down the converter. Once the OVP has been tripped the unit will need to be reset by cycling the input power or by toggling the ON/OFF power before normal operation can resume.

SLC100 units with a non-latching OVP feature are available on request. Please contact the factory for further details.

### Safety

The SLC100 meets safety requirements per UL/CUL 60950 and VDE EN60950, basic insulation rating.

### EMC/EMI Considerations

Analysis pending.

### Performance Characterization

#### Thermal Derating

Maximum output current vs. ambient temperature at various airflow rates has been determined for each model of the SLC100. Each model was analyzed over an ambient temperature range of 0 to 85°C and at air flows up to 600LFM. Temperature limits for thermal derating curves were TBD C for semiconductor junction temperature and TBD C for board temperature.

### Start-Up, ON/OFF and Transient Response

For each model, waveforms are provided showing output voltage response and timing of input voltage power up/down, remote ON/OFF state change and load current transient responses. Output voltage transient responses are provided for step load changes of 50% to 75% & 75% to 50% of rated load current. Waveforms for each

### Efficiency Performance

Efficiency data for each model was determined as a function of both load current and input voltage. Efficiency vs. Input Voltage was measured at full load, ambient temperature of 25°C and airflow of 300LFM. Efficiency vs. Load Current was measured at 25°C, a nominal input voltage of 48Vdc and airflow of 300LFM. Graphs are provided for each model in their respective

**SLC100 1.2VOUT ELECTRICAL SPECIFICATIONS**Specifications are at  $T_A = +25^{\circ}\text{C}$ , Airflow = 300LFM (1.5m/s) at nominal input voltage unless otherwise specified.

	PARAMETER	CONDITIONS	MIN	TYP	MAX	UNITS
<b>INPUT</b>	<b>INPUT</b>					
	Maximum Input Current	Full Load; $V_{in} = 36\text{Vdc}$			1.80	A
	Inrush Charge	$V_{in} = 75\text{Vdc}$			0.180	mC
	Reflected Ripple Current	Full Load, XXMHz Bandwidth			TBD	mApk-pk
	Input Voltage Ripple Rejection	Full Load (100Hz-1KHz)	-30			dB
	No Load Input Current	No Load			55	mA
	Disabled Input Current				3.0	mA
	Quiescent Input Current				2	mA
Recommended Input Fuse	Fast blow external fuse			7	A	
<b>OUTPUT</b>	<b>OUTPUT</b>					
	Voltage Setpoint		1.182	1.2	1.218	Vdc
	Voltage Range	Over all conditions of line, load and temperature	TBD Vdc			TBD
	Line Regulation			0.05	0.10	% of Vnom
	Load Regulation			0.25	0.50	% of Vnom
	Output Ripple			100	120	mVpk-pk
	Output Current Range		0		40 <sup>1</sup>	A
	Output Current Limit Inception		44		48	A
	Efficiency			80		%
	Transient Response	50% to 75% Load Step at di/dt = 0.1 A/mS; Cext = TBD			TBD	
	Peak Deviation				TBD	mV
	Settling Time				TBD	mS
	External Load Capacitance				50,000	mF
	Rated Power				48	W

\* Note 1: Maximum output current for SMD Models is 25A.



## SLC100 1.5VOUT ELECTRICAL SPECIFICATIONS

Specifications are at  $T_A = +25^{\circ}\text{C}$ , Airflow = 300LFM (1.5m/s) at nominal input voltage unless otherwise specified.

	PARAMETER	CONDITIONS	MIN	TYP	MAX	UNITS
INPUT	<b>INPUT</b>					
	Maximum Input Current	Full Load; $V_{in} = 36\text{Vdc}$			2.20	A
	Inrush Charge	$V_{in} = 75\text{Vdc}$			0.180	mC
	Reflected Ripple Current	Full Load, XXMHz Bandwidth			TBD	mApk-pk
	Input Voltage Ripple Rejection	Full Load (100Hz-1KHz)	-30			dB
	No Load Input Current	No Load			75	mA
	Disabled Input Current				3.0	mA
	Quiescent Input Current				2	mA
	Recommended Input Fuse	Fast blow external fuse			7	A
OUTPUT	<b>OUTPUT</b>					
	Voltage Setpoint		1.490	1.5	1.520	Vdc
	Voltage Range	Over all conditions of line, load and temperature	TBD			TBD
	Line Regulation			0.05	0.10	% of Vnom
	Load Regulation			0.25	0.50	% of Vnom
	Output Ripple				100	mVpk-pk
	Output Current Range		0		40 <sup>1</sup>	A
	Output Current Limit Inception		44		48	A
	Efficiency		82			%
	Transient Response	50% to 75% Load Step at di/dt = 0.1 A/mS; Cext = TBD				TBD
	Peak Deviation					TBD
	Settling Time					TBD
	External Load Capacitance					50,000
	Rated Power					48
					W	

\* Note 1: Maximum output current for SMD Models is 25A.



Murata Power Solutions, Inc.

11 Cabot Boulevard, Mansfield, MA 02048-1151 U.S.A.

Tel: (508) 339-3000 (800) 233-2765 Fax: (508) 339-6356

www.murata-ps.com email: sales@murata-ps.com ISO 9001 & ISO 14001 REGISTERED

Murata Power Solutions, Inc. makes no representation that the use of its products in the circuits described herein, or the use of other technical information contained herein, will not infringe upon existing or future patent rights. The descriptions contained herein do not imply the granting of licenses to make, use, or sell equipment constructed in accordance therewith. Specifications are subject to change without notice.  
© 2009 Murata Power Solutions, Inc.

**USA:** Mansfield (MA), Tel: (508) 339 3000, email: sales@murata-ps.com

**Canada:** Toronto, Tel: (866) 740 1232, email: toronto@murata-ps.com

**UK:** Milton Keynes, Tel: +44 (0)1908 615232, email: mk@murata-ps.com

**France:** Montigny Le Bretonneux, Tel: +33 (0)1 34 60 01 01, email: france@murata-ps.com

**Germany:** München, Tel: +49 (0)89-544334-0, email: ped.munich@murata-ps.com

**Japan:** Tokyo, Tel: 3-3779-1031, email: sales\_tokyo@murata-ps.com

Osaka, Tel: 6-6354-2025, email: sales\_osaka@murata-ps.com

**China:** Shanghai, Tel: +86 215 027 3678, email: shanghai@murata-ps.com

Guangzhou, Tel: +86 208 221 8066, email: guangzhou@murata-ps.com

**Singapore:** Parkway Centre, Tel: +65 6348 9096, email: singapore@murata-ps.com