

INCLINOMETER SUB-ASSEMBLY
SCL1700-D31
PRODUCT SPECIFICATION

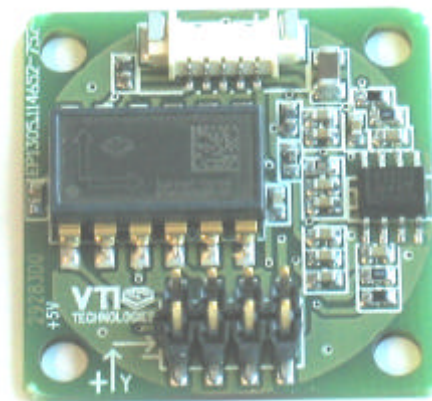

1 General description

This document describes an inclinometer sub-assembly module, suitable to be built-in in various industrial applications. Inclinometer is available in 2 axis configuration, for horizontal mounting (X and Y tilt measurement). The sensor technology used is VTI's 3D MEMS, with appropriate ASIC circuitry. Output signals are analogue voltage.

1.1 Block diagram

Products are based on VTI's inclinometer sensor component, mounted on PCB. Electronics is not encapsulated.

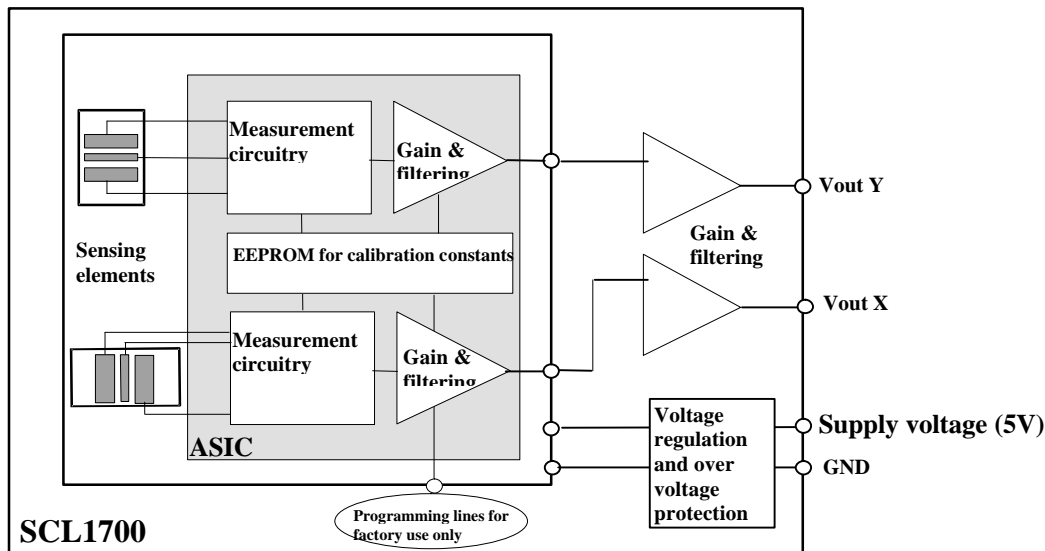

Picture 1. Block diagram

1.2 Inclinometer Features

- Available range: $\pm 15^\circ$
- Controlled frequency response
- Easy to use and design in
- Analogue voltage output
- Dual axis inclination measurement
- Built-in failure detection

Benefits

- Excellent long term stability
- Outstanding shock durability
- High resolution
- Harsh environment robustness

2 Specifications

2.1 Operating specification

Parameter	Condition	Min.	Typ	Max.	Units
Supply voltage		4.75	5	5.25	V
Current consumption	No load		4.5		mA
Output load	Resistive	50	20		kΩ
	Capacitive			20	nF
Operating temperature		-40		85	°C

2.2 Performance Specification

Parameter	Condition	Min.	Typ	Max.	Units
Measuring range ⁽¹⁾			± 15		°
Offset ^(2,3,4)	Output @ 0°	2.48	Vdd/2		V
Offset calibration error ^(3,4,5)			± 0.1	±0.2	°
Offset temperature error ^(3,4,6)	-5...50°C		±0.05	±0.1	°
	-25°C...70°C		±0.1	±0.2	°
Sensitivity ^(3,4,7)	@ 0° (offset position)	148	150	152	mV / °
Sensitivity calibration error ^(3,4,8)			± 1		%
Sensitivity temperature error ^(3,4,9)	-5...50°C			±0.5	%
	-25°C...70°C	-1		±1	%
Nonlinearity ⁽¹⁰⁾			± 0.03	±0.05	°
Frequency response -3dB	True DC response		3		Hz
Cross-axis sensitivity			2	4	%
Alignment error	X vs.Y axis			1	°
Output noise DC...10 Hz	@ 0° (offset position)		< 0.001		°

Note 1. The measuring range is limited by sensitivity, offset and supply voltage rails of the device.

Note 2. Offset specified as $V_{\text{offset}} = V_{\text{out}}(@0^\circ)$ [V].

Note 3. +5V supply voltage used in calibration and testing.

Note 4. See proposed connection of SCL1700 in picture 2.

Note 5. Offset calibration error specified as $\text{Offset_Calib_error} = \arcsin(\text{Offset_Calib_error_in_g})$ [°],

$\text{Offset_Calib_error_in_g} = \{V_{\text{out}}(@0^\circ) - 2.5\text{ V}\} / V_{\text{sens}} [\text{g}]$, $V_{\text{sens}}=8.595\text{ V/g}$.

Note 6. Offset temperature error specified as $\text{Offset_Error_@_temp} = \arcsin(\text{Offset_Error_@_temp_in_g})$ [°],

$\text{Offset_Error_@_temp_in_g} = \{V_{\text{out}} @ \text{temp.} - V_{\text{out}} @ \text{room temp.}\} / V_{\text{sens}} [\text{g}]$, $V_{\text{sens}}=8.595\text{ V/g}$.

Note 7. Sensitivity target in calibration 8.595 V/g (→ 150 mV/°)

Sensitivity specified as $V_{\text{sens}} = \{V_{\text{out}}(@+10^\circ) - V_{\text{out}}(@-10^\circ)\} / (2 \cdot \sin(10^\circ) \text{ g})$ [V/g].

Note 8. Sensitivity calibration error specified as $\text{Sensitivity_calibr_error} = \{V_{\text{sens}} - V_{\text{sens_nom}}\} / V_{\text{sens_nom}} \times 100\%$ [%],

$V_{\text{sens_nom}}$ = nominal sensitivity.

Note 9. Sensitivity temperature error specified as

$\text{Sensitivity_temp_error} = \{V_{\text{sens}} @ \text{temp} - V_{\text{sens}} @ \text{room temp}\} / V_{\text{sens}} @ \text{room temp} \times 100\%$ [%].

Note 10. From best fit sine-function to output through -10° and +10° (SINE COMPENSATED).

2.3 Absolute maximum rating

Parameter	Condition	Min.	Typ	Max.	Units
Supply voltage				5,5	V
Current consumption	No load			5	mA
Output load	Resistive	50			kΩ
	Capacitive			10	nF
Storage temp		-40		125	°C
Mechanical shock	1m drop on concrete	20 000			g

2.4 Electrical Connection

Connector: Molex 53261-0590, see picture 2.

Pin No.	Name	Function
1	V _{cc}	Power supply
2	NC	Not connected
3	GND	Ground
4	Out X	X axis output voltage
5	Out Y	Y axis output voltage

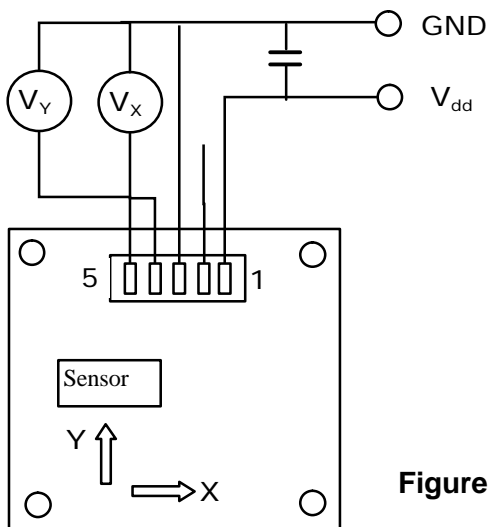
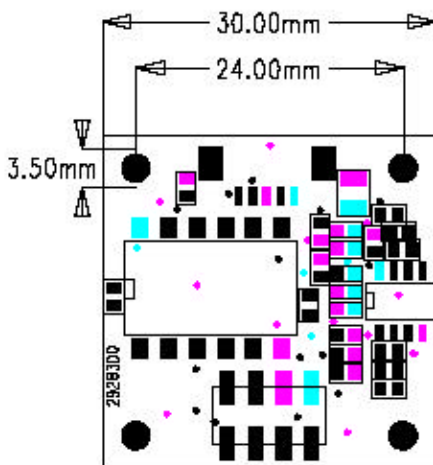

Figure 2. Connection of SCL1700

3 Mechanical specification

3.1 Dimensions



- PCB Material: FR4
- PCB thickness: 1.6 mm
- Size: 30 mm × 30 mm
- Mounting holes: Ø 3.5 mm
- Height: 7mm (with pin header 11 mm)
- Weight: < 10 g
- Connector: Molex 53261-0590, mates with Molex 51021-0500

Picture 3. SCL1700 mechanical dimensions.

3.2 Mounting

The sensor module is to be mounted with 4 screws, dimension M3, on a horizontal plane. The mounting surface must be electrically isolated, and in well defined position. It is advised to adjust the offset position after final assembly of the sensor, to achieve maximum performance.

4 Typical performance

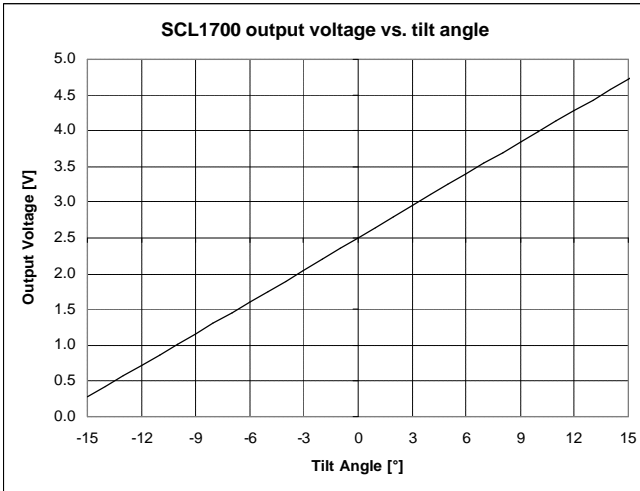

SCL1700 output signal.

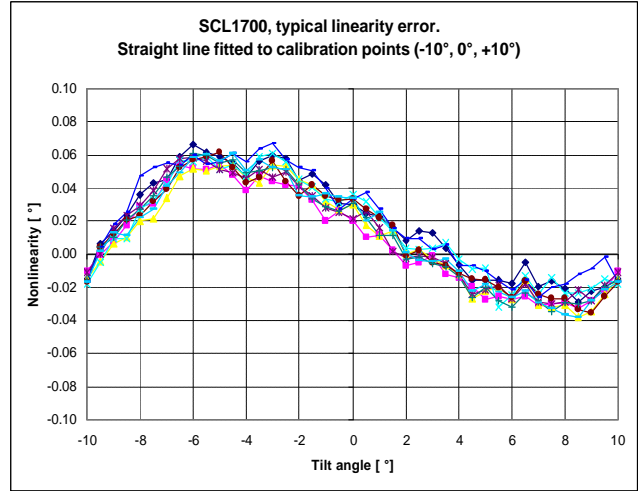

Typical nonlinearity

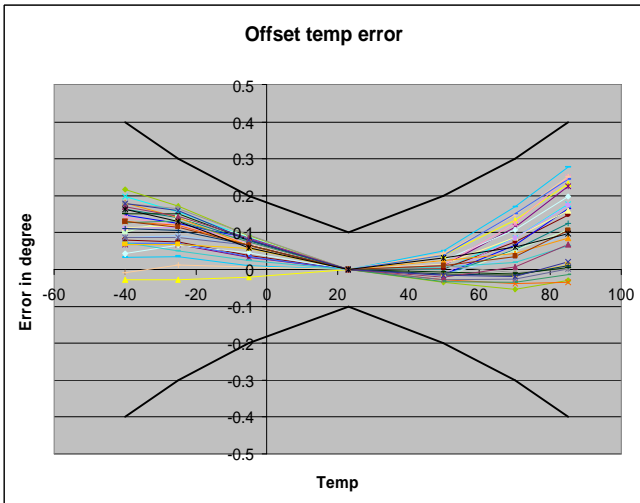

Typical Offset Error over temperature

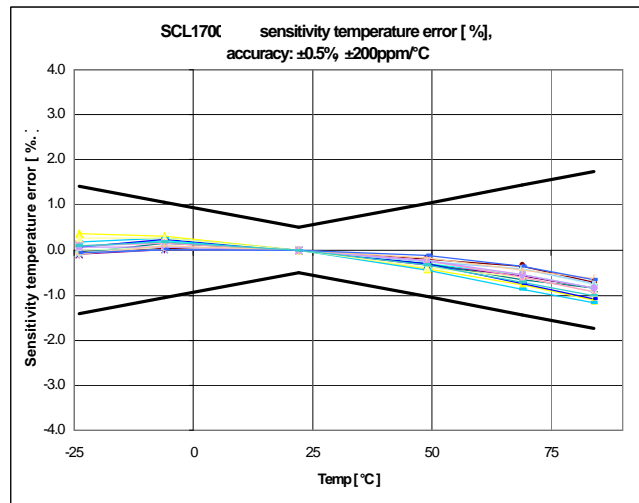

Typical Sensitivity Error over temperature