

## SKT 1000, SKT 1200

$V_{RSM}$	$V_{RRM}$ $V_{DRM}$	$(dv/dt)_{cr}$	$I_{TRMS}$ (maximum values for continuous operation)	
			2300 A	2800 A
V	V	V/ $\mu$ s	$I_{TAV}$ (sin. 180; $T_{case} = \dots$ ; DSC)	
			1465 A (58 °C)	1780 A (55 °C)
1300	1200	1000	<b>SKT 1000/12 E L3</b>	<b>SKT 1200/12 E L3</b>
1500	1400	1000	–	<b>SKT 1200/14 E L3</b>
1700	1600	1000	<b>SKT 1000/16 E L3</b>	<b>SKT 1200/16 E L3</b>
1900	1800	1000	–	<b>SKT 1200/18 E L3</b>
2300	2200	1000	<b>SKT 1000/22 E L2</b>	–
2700	2600	1000	<b>SKT 1000/26 E L2</b>	–
2900	2800	1000	<b>SKT 1000/28 E L2</b>	–

## Thyristors

### SKT 1000 SKT 1200



Symbol	Conditions	SKT 1000	SKT 1200	Units
$I_{TAV}$	sin. 180; $T_{case} = 85$ °C; DSC	1000	1200	A
$I_{TSM}$	$T_{vj} = 25$ °C; 10 ms $T_{vj} = 125$ °C; 10 ms	19 000 16 500	30 000 25 500	A A
$i^2t$	$T_{vj} = 25$ °C; 8,3 ... 10 ms $T_{vj} = 125$ °C; 8,3 ... 10 ms	1 800 1 360	4 500 3 250	$kA^2s$ $kA^2s$
$t_{gd}$	$T_{vj} = 25$ °C $I_G = 1$ A $di_G/dt = 1$ A/ $\mu$ s	typ. 1		$\mu$ s
$t_{gr}$	$V_D = 0,67 \cdot V_{DRM}$	typ. 2		$\mu$ s
$(di/dt)_{cr}$	$f = 50 \dots 60$ Hz	125		A/ $\mu$ s
$I_H$	$T_{vj} = 25$ °C; typ./max.	250 / 500		mA
$I_L$	$T_{vj} = 25$ °C; $R_G = 33$ $\Omega$ ; typ./max.	0,5 / 2		A
$t_q$	$T_{vj} = 125$ °C; typ.	100 ... 250		$\mu$ s
$V_T$	$T_{vj} = 25$ °C; $I_T = 3600$ A; max.	2,0	1,65	V
$V_{T(TO)}$	$T_{vj} = 125$ °C	1,14	0,95	V
$r_T$	$T_{vj} = 125$ °C	0,243	0,18	m $\Omega$
$I_{DD}; I_{RD}$	$T_{vj} = 125$ °C; $V_{RD} = V_{RRM}$ $V_{DD} = V_{DRM}$	100		mA
$V_{GT}$	$T_{vj} = 25$ °C	5		V
$I_{GT}$	$T_{vj} = 25$ °C	250		mA
$V_{GD}$	$T_{vj} = 125$ °C	0,25		V
$I_{GD}$	$T_{vj} = 125$ °C	10		mA
$R_{thjc}$	cont.; sin. 180; DSC/SSC rec. 120; DSC/SSC	0,021 0,0225 / 0,054 0,027 / 0,060		$^{\circ}C/W$ $^{\circ}C/W$ $^{\circ}C/W$
$R_{thch}$	DSC/SSC	0,005 / 0,010		$^{\circ}C/W$
$T_{vj}$		– 40 ... + 125		$^{\circ}C$
$T_{stg}$		– 40 ... + 130		$^{\circ}C$
F	SI units	22 ... 25		kN
	US units	5000 ... 5600		lbs.
w		510		g
Case		B 14 A		

### Features

- Hermetic metal cases with ceramic insulators
- Capsule packages for double sided cooling
- International standard cases
- Off-state and reverse voltages up to 2800 V
- Amplifying gate

### Typical Applications

- DC motor control (e. g. for machine tools)
- Controlled rectifiers (e. g. for battery charging)
- AC controllers (e. g. for temperature control)

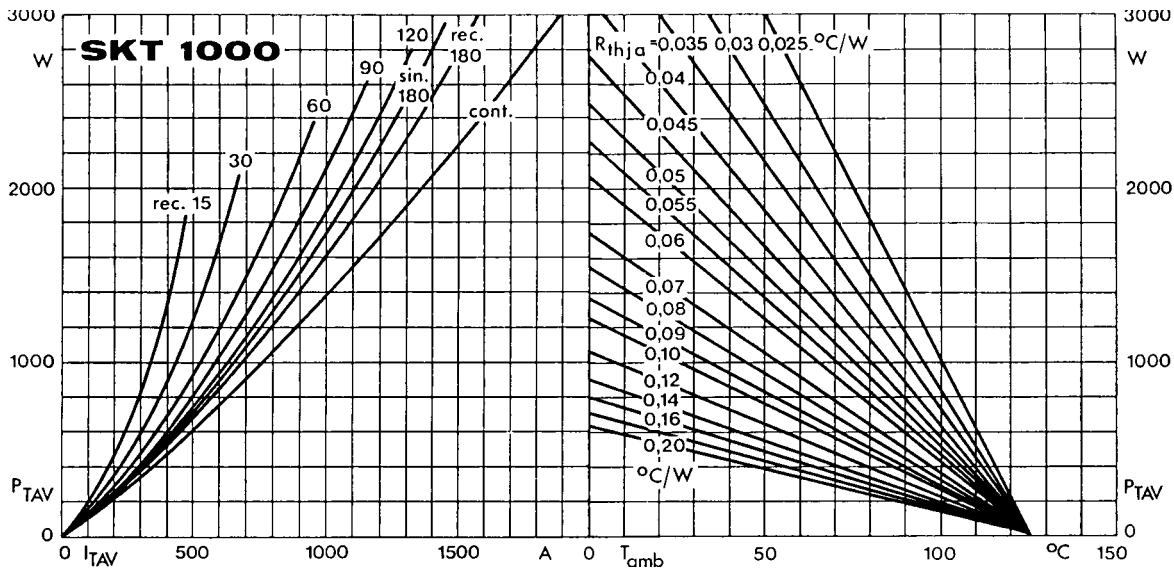

Fig. 1 a Power dissipation vs. on-state current and ambient temperature

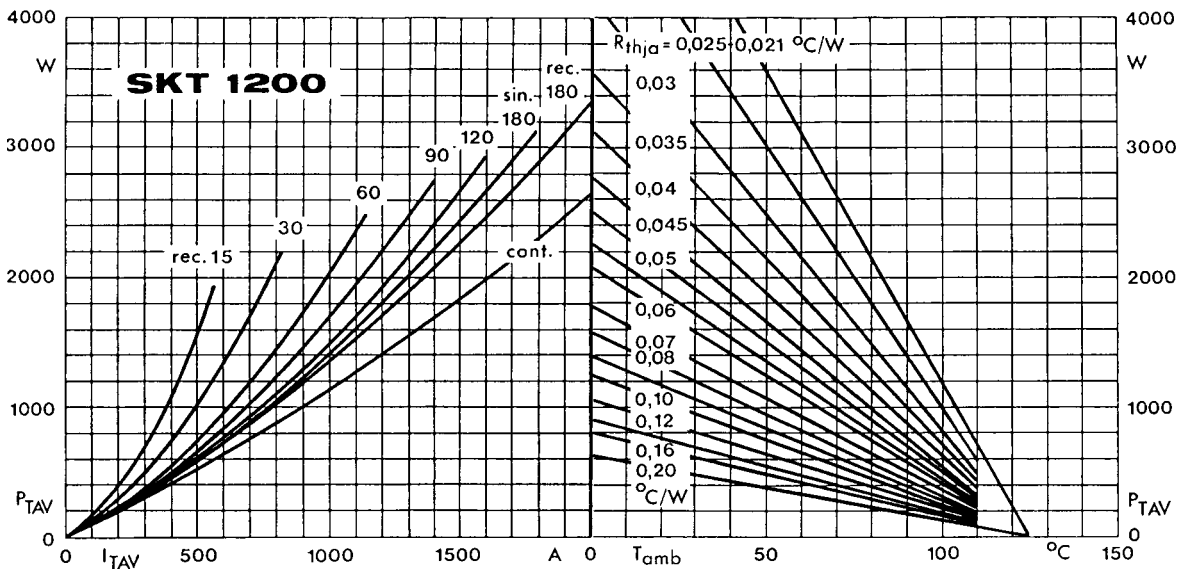

Fig. 1 b Power dissipation vs. on-state current and ambient temperature

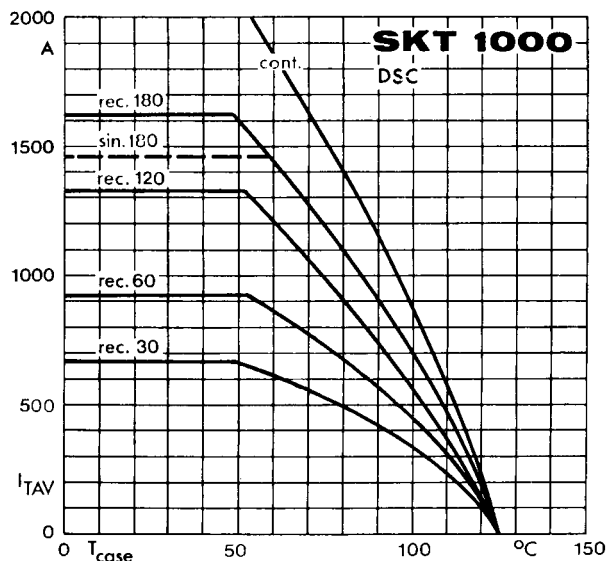

Fig. 2 a Rated on-state current vs. case temperature

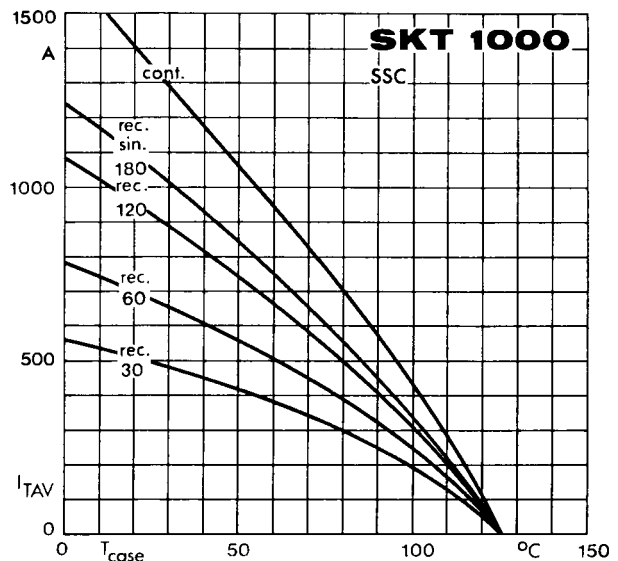

Fig. 2 b Rated on-state current vs. case temperature

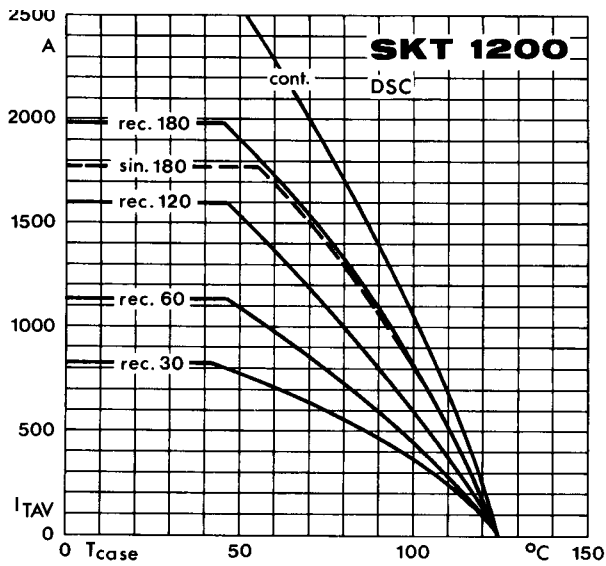

Fig. 2 c Rated on-state current vs. case temperature

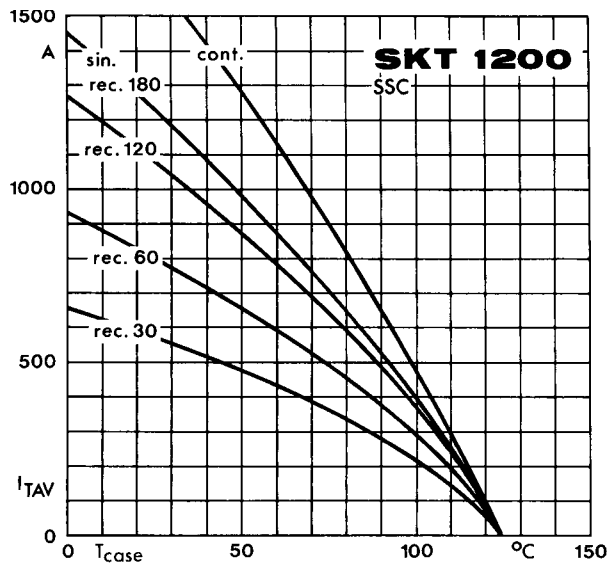

Fig. 2 d Rated on-state current vs. case temperature

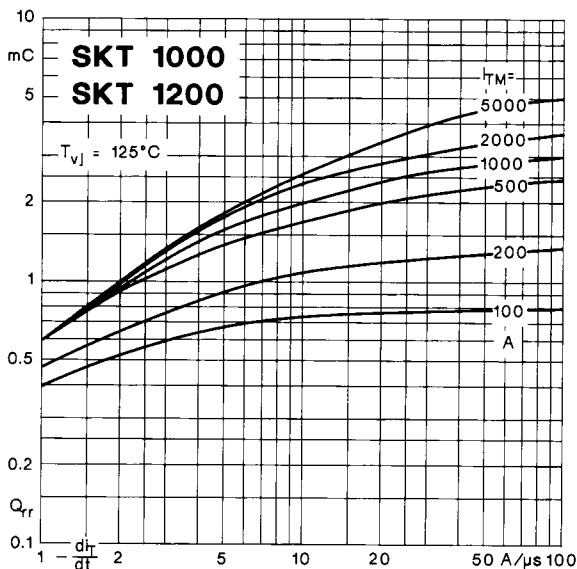

Fig. 3 Recovered charge vs. current decrease

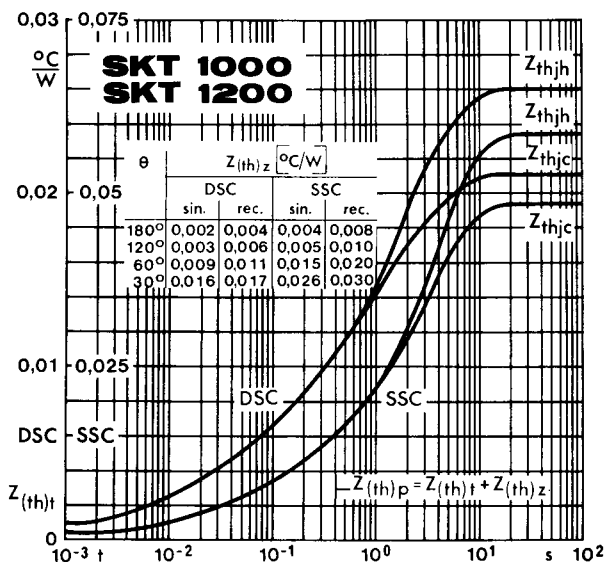

Fig. 4 Transient thermal impedance vs. time

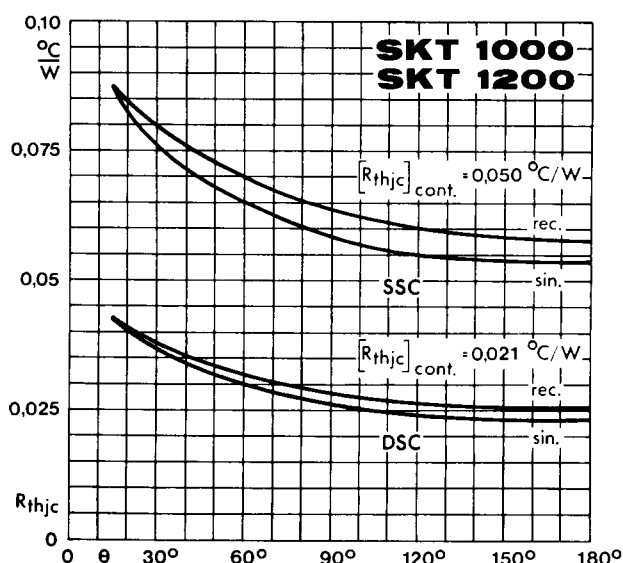

Fig. 5 Thermal resistance vs. conduction angle

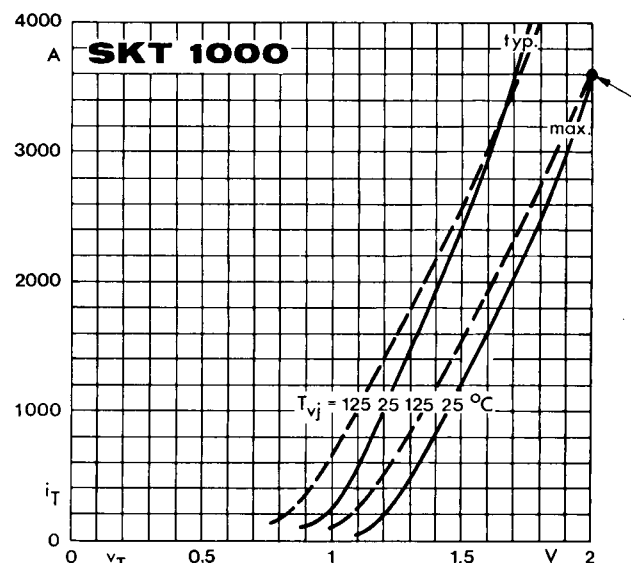

Fig. 6 a On-state characteristics

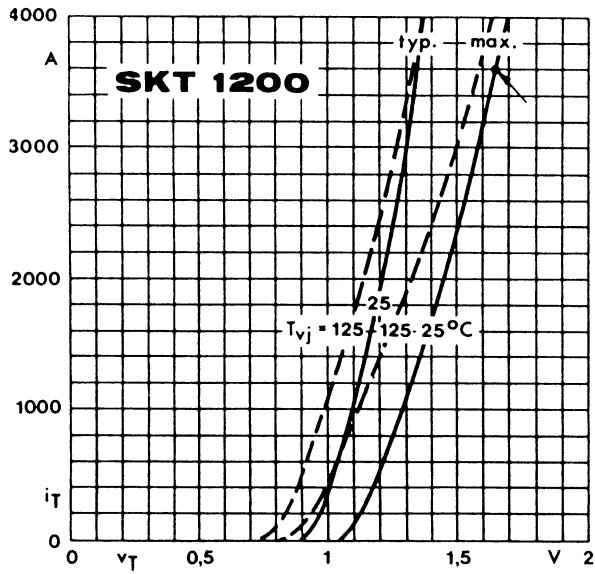

Fig. 6 b On-state characteristics

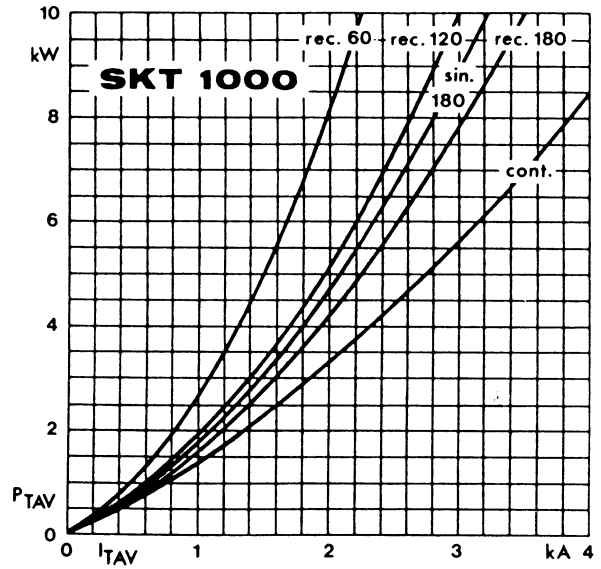

Fig. 7 a Power dissipation vs. on-state current

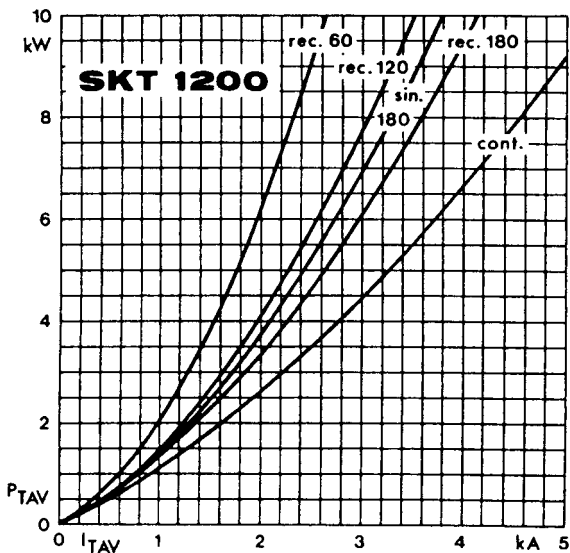

Fig. 7 b Power dissipation vs. on-state current

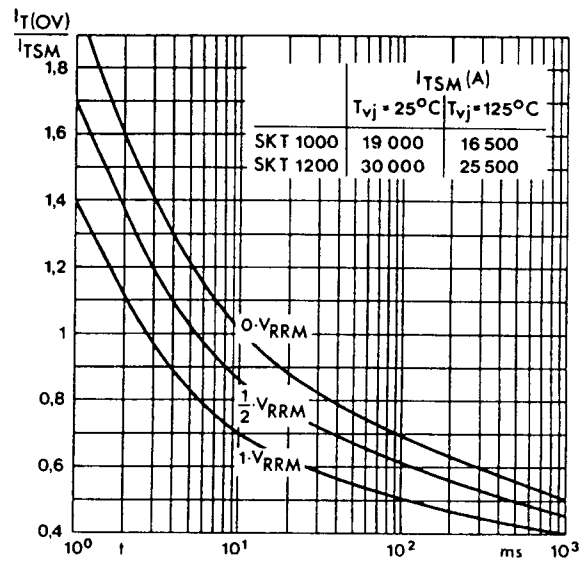

Fig. 8 Surge overload current vs. time

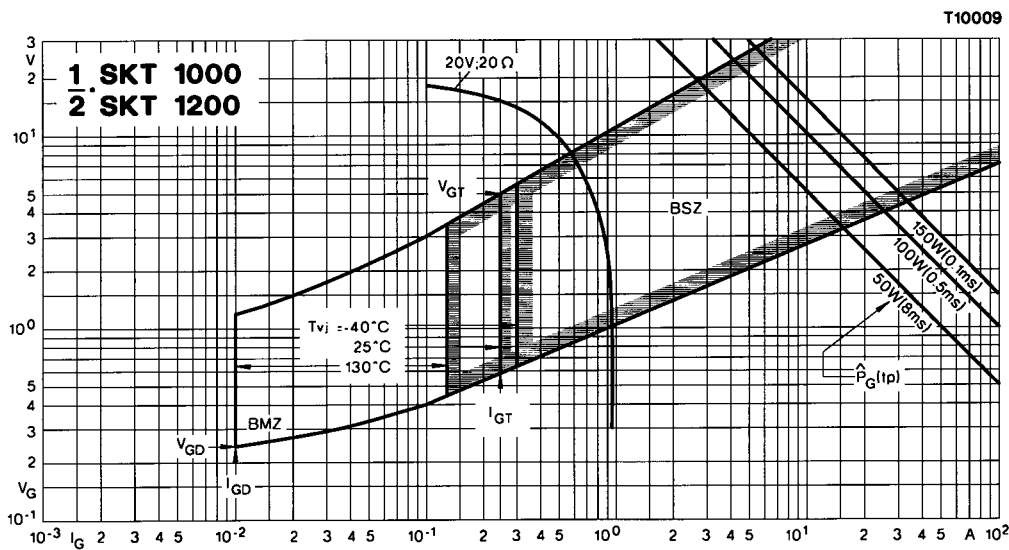

Fig. 9 Gate trigger characteristics

## SKT 1000, SKT 1200

SKT 1000/. . . L3

SKT 1200/. . . L3

Case B 14 A

DIN 41814: 155 B 4

JEDEC: TO-200 AD

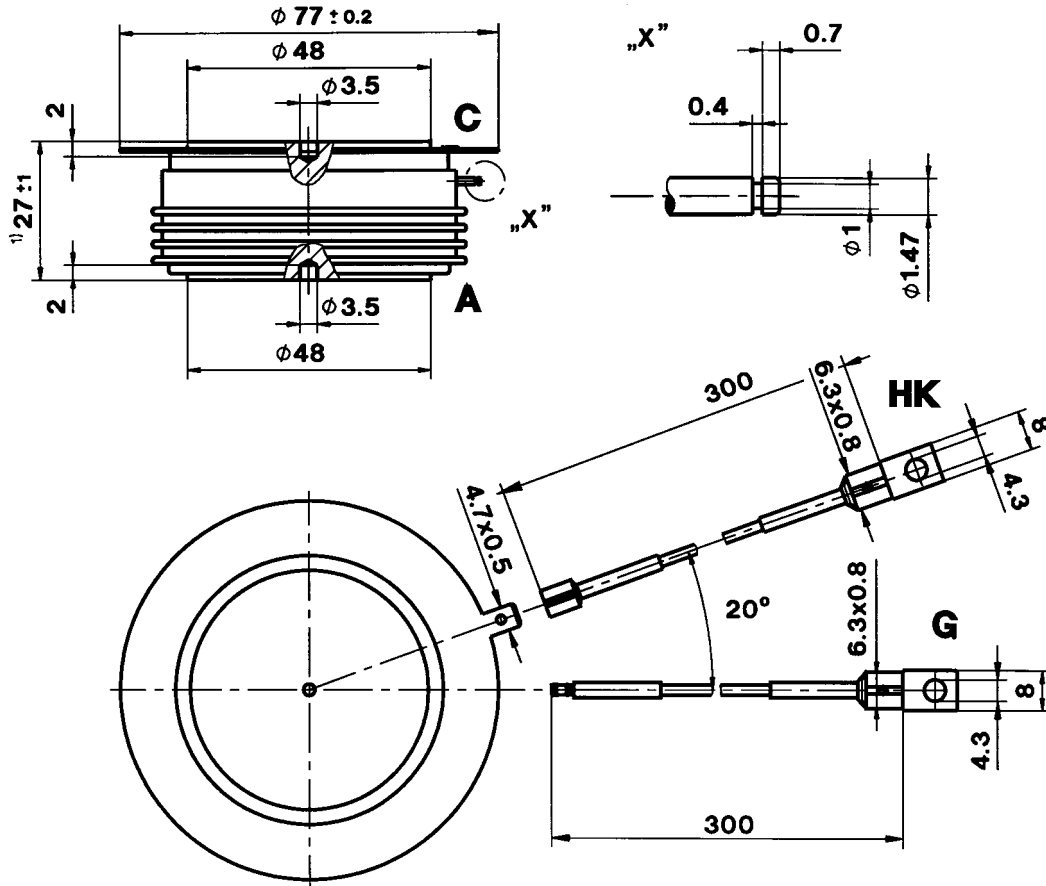

Dimensions in mm

<sup>1)</sup> SKT 1000/. . . L2: 27,5 mm

- C: Cathode terminal
- A: Anode terminal
- G: Gate terminal (yellow sleeve)
- HK: Auxiliary cathode terminal (red sleeve)