

# DATA SHEET

## **TDA8765**

**10-bit high-speed Analog-to-Digital  
Converter (ADC)**

Preliminary specification  
Supersedes data of 1998 May 08  
File under Integrated Circuits, IC02

1999 Jan 06

# 10-bit high-speed Analog-to-Digital Converter (ADC)

## TDA8765

### FEATURES

- 10-bit resolution
- Sampling rate up to 55 MHz
- –3 dB bandwidth of 200 MHz
- 5 V power supplies
- Binary or twos-complement CMOS outputs
- In-range CMOS-compatible output
- TLL- CMOS-compatible static digital inputs
- 3 to 5 V CMOS-compatible digital outputs
- Differential clock input; Positive Emitter Coupled Logic (PECL) compatible
- Power dissipation 325 mW (typical)
- Low analog input capacitance (typical 2 pF), no buffer amplifier required
- Integrated sample-and-hold amplifier
- Differential analog input
- External amplitude range control
- Voltage controlled regulator included.

### APPLICATIONS

- High-speed analog-to-digital conversion for
  - Video signal digitizing
  - High Definition TV (HDTV)
  - Imaging (camera scanner)
  - Medical imaging
  - Telecommunication
  - Base-station receiver.

### GENERAL DESCRIPTION

The TDA8765 is a bipolar 10-bit Analog-to-Digital Converter (ADC) optimized for telecommunications and professional imaging. It converts the analog input signal into 10-bit binary coded digital words at a maximum sampling rate of 55 MHz. All static digital inputs (SH,  $\overline{\text{CE}}$  and OTC) are TTL and CMOS compatible and all outputs are CMOS compatible. A sine wave clock input signal can also be used.

### QUICK REFERENCE DATA

SYMBOL	PARAMETER	CONDITIONS	MIN.	TYP.	MAX.	UNIT
$V_{\text{CCA}}$	analog supply voltage		4.75	5.0	5.25	V
$V_{\text{CCD}}$	digital supply voltage		4.75	5.0	5.25	V
$V_{\text{CCO}}$	output supply voltage		3.0	3.3	5.25	V
$I_{\text{CCA}}$	analog supply current		–	33	tbf	mA
$I_{\text{CCD}}$	digital supply current		–	30	tbf	mA
$I_{\text{CCO}}$	output supply current	$f_{\text{CLK}} = 4 \text{ MHz}; f_i = 400 \text{ kHz}$	–	3.2	tbf	mA
INL	integral non-linearity	$f_{\text{CLK}} = 4 \text{ MHz}; f_i = 400 \text{ kHz}$	–	$\pm 0.5$	$\pm 1.75$	LSB
DNL	differential non-linearity	$f_{\text{CLK}} = 4 \text{ MHz}; f_i = 400 \text{ kHz}$	–	$\pm 0.3$	$\pm 0.5$	LSB
$f_{\text{CLK(max)}}$	maximum clock frequency					
	TDA8765H/4		40	–	–	MHz
	TDA8765H/5		55	–	–	MHz
$P_{\text{tot}}$	total power dissipation		–	325	tbf	mW

### ORDERING INFORMATION

TYPE NUMBER	PACKAGE			SAMPLING FREQUENCY (MHz)
	NAME	DESCRIPTION	VERSION	
TDA8765H/4	QFP44	plastic quad flat package; 44 leads (lead length 1.3 mm); body 10 × 10 × 1.75 mm	SOT307-2	40
TDA8765H/5				55

# 10-bit high-speed Analog-to-Digital Converter (ADC)

TDA8765

## BLOCK DIAGRAM

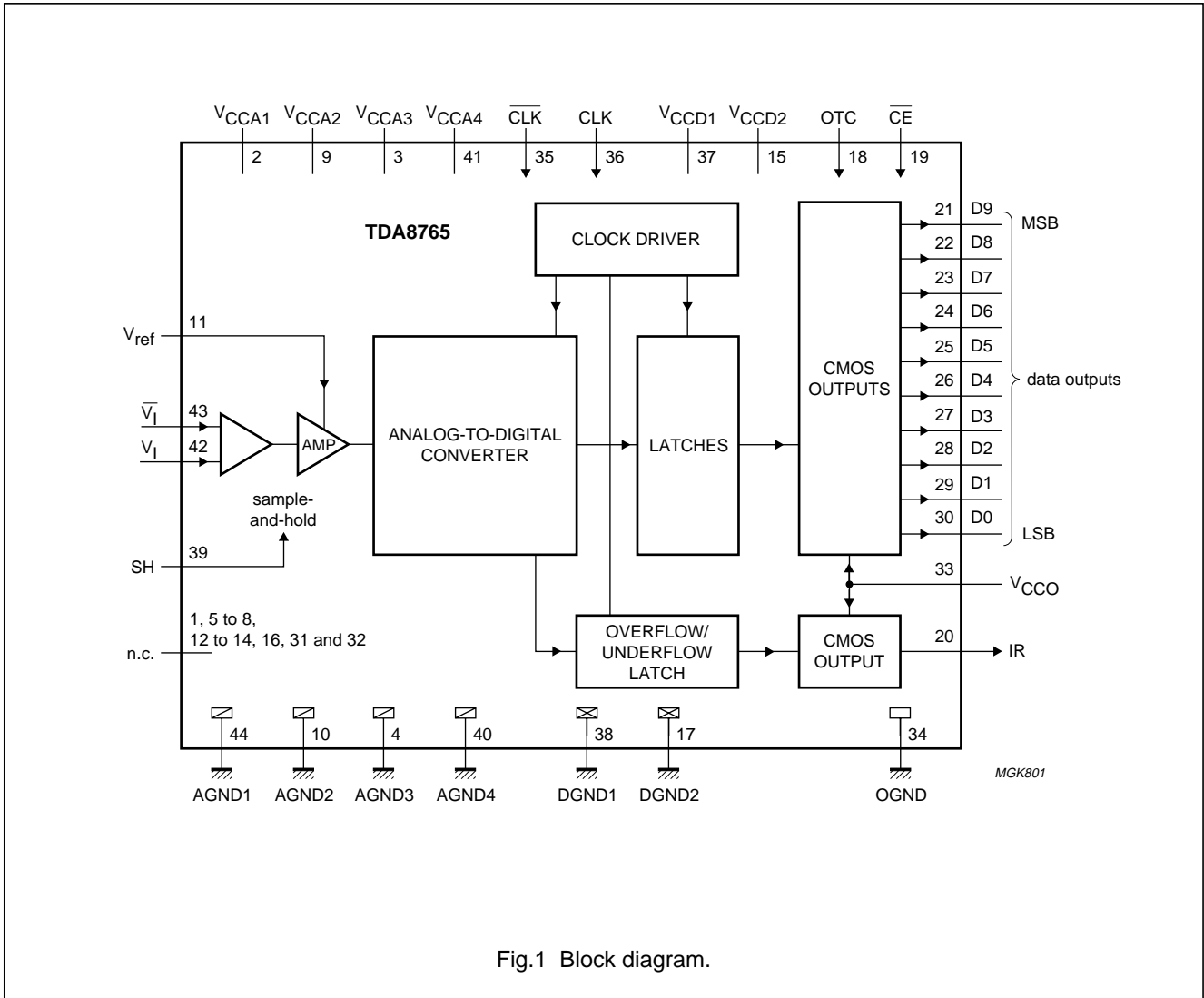

Fig.1 Block diagram.

# 10-bit high-speed Analog-to-Digital Converter (ADC)

TDA8765

## PINNING

SYMBOL	PIN	DESCRIPTION
n.c.	1	not connected
V <sub>CCA1</sub>	2	analog supply voltage 1 (+5 V)
V <sub>CCA3</sub>	3	analog supply voltage 3 (+5 V)
AGND3	4	analog ground 3
n.c.	5	not connected
n.c.	6	not connected
n.c.	7	not connected
n.c.	8	not connected
V <sub>CCA2</sub>	9	analog supply voltage 2 (+5 V)
AGND2	10	analog ground 2
V <sub>ref</sub>	11	reference voltage input
n.c.	12	not connected
n.c.	13	not connected
n.c.	14	not connected
V <sub>CCD2</sub>	15	digital supply voltage 2 (+5 V)
n.c.	16	not connected
DGND2	17	digital ground 2
OTC	18	control input twos complement output; active HIGH
$\overline{\text{CE}}$	19	chip enable input (CMOS level; active LOW)
IR	20	in-range output
D9	21	data output; bit 9 (MSB)
D8	22	data output; bit 8

SYMBOL	PIN	DESCRIPTION
D7	23	data output; bit 7
D6	24	data output; bit 6
D5	25	data output; bit 5
D4	26	data output; bit 4
D3	27	data output; bit 3
D2	28	data output; bit 2
D1	29	data output; bit 1
D0	30	data output; bit 0 (LSB)
n.c.	31	not connected
n.c.	32	not connected
V <sub>CCO</sub>	33	output supply voltage (3 to 5.25 V)
OGND	34	output ground
$\overline{\text{CLK}}$	35	complementary clock input; active LOW
CLK	36	clock input
V <sub>CCD1</sub>	37	digital supply voltage 1 (+5 V)
DGND1	38	digital ground 1
SH	39	sample-and-hold enable input (CMOS level; active HIGH)
AGND4	40	analog ground 4
V <sub>CCA4</sub>	41	analog supply voltage 4 (+5 V)
V <sub>I</sub>	42	positive analog input voltage
$\overline{\text{V}}_I$	43	negative analog input voltage
AGND1	44	analog ground 1

10-bit high-speed Analog-to-Digital Converter (ADC)

TDA8765

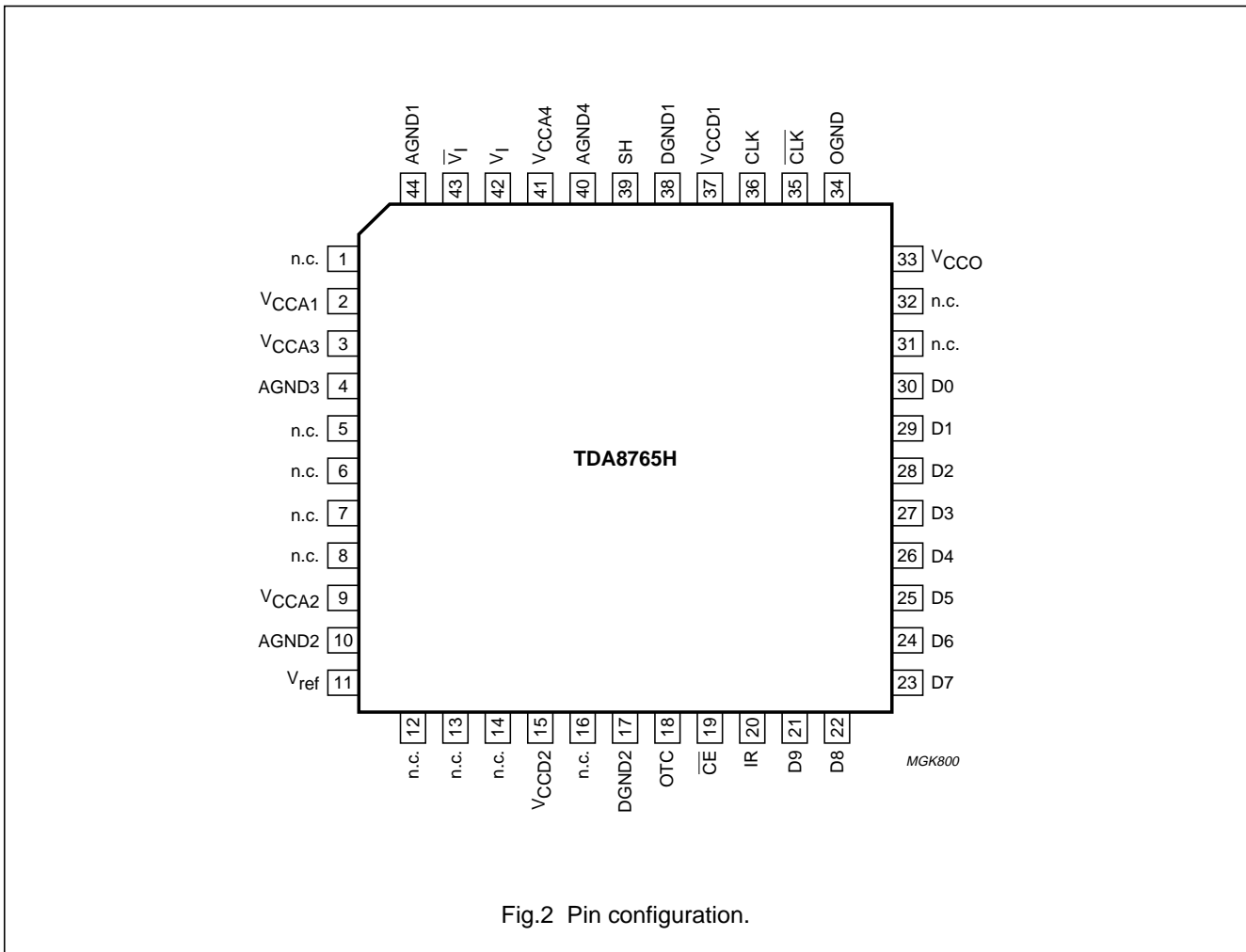

Fig.2 Pin configuration.

# 10-bit high-speed Analog-to-Digital Converter (ADC)

TDA8765

## LIMITING VALUES

In accordance with the Absolute Maximum Rating System (IEC 134).

SYMBOL	PARAMETER	CONDITIONS	MIN.	MAX.	UNIT
$V_{CCA}$	analog supply voltage	note 1	-0.3	+7.0	V
$V_{CCD}$	digital supply voltage	note 1	-0.3	+7.0	V
$V_{CCO}$	output supply voltage	note 1	-0.3	+7.0	V
$\Delta V_{CC}$	supply voltage difference				
	$V_{CCA} - V_{CCD}$		-1.0	+1.0	V
	$V_{CCD} - V_{CCO}$		-1.0	+4.0	V
	$V_{CCA} - V_{CCO}$		-1.0	+4.0	V
$V_I$	input voltage at pins 42 and 43	referenced to AGND	0.3	$V_{CCA}$	V
$V_{i(p-p)}$	input voltage at pins 35 and 36 for differential clock drive (peak-to-peak value)		-	$V_{CCD}$	V
$I_O$	output current		-	10	mA
$T_{stg}$	storage temperature		-55	+150	°C
$T_{amb}$	operating ambient temperature		0	+85	°C
$T_j$	junction temperature		-	150	°C

### Note

- The supply voltages  $V_{CCA}$ ,  $V_{CCD}$  and  $V_{CCO}$  may have any value between -0.3 and +7.0 V provided that the supply voltage differences  $\Delta V_{CC}$  are respected.

## HANDLING

Inputs and outputs are protected against electrostatic discharges in normal handling. However, to be totally safe, it is desirable to take normal precautions appropriate to handling integrated circuits.

## THERMAL CHARACTERISTICS

SYMBOL	PARAMETER	CONDITION	VALUE	UNIT
$R_{th(j-a)}$	thermal resistance from junction to ambient	in free air	75	K/W

# 10-bit high-speed Analog-to-Digital Converter (ADC)

TDA8765

## CHARACTERISTICS

$V_{CCA} = V_2$  to  $V_{44}$ ,  $V_9$  to  $V_{10}$ ,  $V_3$  to  $V_4$  and  $V_{41}$  to  $V_{40} = 4.75$  to  $5.25$  V;  $V_{CCD} = V_{37}$  to  $V_{38}$  and  $V_{15}$  to  $V_{17} = 4.75$  to  $5.25$  V;  $V_{CCO} = V_{33}$  to  $V_{34} = 3.0$  to  $5.25$  V; AGND and DGND shorted together;  $T_{amb} = 0$  to  $85$  °C; typical values measured at  $V_{CCA} = V_{CCD} = 5$  V and  $V_{CCO} = 3.3$  V,  $T_{amb} = 25$  °C,  $V_{I(p-p)} - \bar{V}_{I(p-p)} = 2.0$  V and  $C_L = 10$  pF; unless otherwise specified.

SYMBOL	PARAMETER	CONDITIONS	MIN.	TYP.	MAX.	UNIT
<b>Supply</b>						
$V_{CCA}$	analog supply voltage		4.75	5.0	5.25	V
$V_{CCD}$	digital supply voltage		4.75	5.0	5.25	V
$V_{CCO}$	output supply voltage		3.0	3.3	5.25	V
$I_{CCA}$	analog supply current		–	33	45	mA
$I_{CCD}$	digital supply current		–	30	37	mA
$I_{CCO}$	output supply current	$f_{CLK} = 4$ MHz; $f_i = 400$ kHz	–	3.2	tbf	mA
		$f_{CLK} = 40$ MHz; $f_i = 4.43$ MHz	–	11	tbf	mA
<b>Inputs</b>						
CLK and $\overline{CLK}$ (REFERENCED TO DGND)						
$V_{IL}$	LOW-level input voltage	$V_{CCD} = 5$ V; note 1	3.19	–	3.52	V
$V_{IH}$	HIGH-level input voltage	$V_{CCD} = 5$ V; note 1	3.83	–	4.12	V
$I_{IL}$	LOW-level input current	$V_{CLK}$ or $V_{\overline{CLK}} = 3.19$ V	–10	–	–	$\mu$ A
$I_{IH}$	HIGH-level input current	$V_{CLK}$ or $V_{\overline{CLK}} = 3.83$ V	–	–	10	$\mu$ A
$Z_i$	input impedance	$f_{CLK} = 40$ MHz	2	–	–	k $\Omega$
$C_i$	input capacitance	$f_{CLK} = 40$ MHz	–	–	2	pF
$\Delta V_{CLK(p-p)}$	differential AC input voltage for switching ( $V_{CLK} - V_{\overline{CLK}}$ ; peak-to-peak value)	DC voltage level = 2.5 V	0.5	–	2.0	V
OTC, SH AND $\overline{CE}$ (REFERENCED TO DGND); see Tables 2 and 3						
$V_{IL}$	LOW-level input voltage		0	–	0.8	V
$V_{IH}$	HIGH-level input voltage		2.0	–	$V_{CCD}$	V
$I_{IL}$	LOW-level input current	$V_{IL} = 0.8$ V	–20	–	–	$\mu$ A
$I_{IH}$	HIGH-level input current	$V_{IH} = 2.0$ V	–	–	20	$\mu$ A
$V_I$ AND $\bar{V}_I$ (REFERENCED TO AGND; see Table 1); $V_{REF} = V_{CCA} - 1.825$ V						
$I_{IL}$	LOW-level input current		–	10	–	$\mu$ A
$I_{IH}$	HIGH-level input current		–	10	–	$\mu$ A
$R_i$	input resistance	$f_i = 4.43$ MHz	100	–	–	k $\Omega$
$C_i$	input capacitance	$f_i = 4.43$ MHz	–	–	2	pF
$V_{I(CM)}$	common mode input voltage	$V_I = \bar{V}_I$ ; output code 511 $V_{CCA} = 5$ V	tbf	3.6	tbf	V
		$V_{CCA} = 4.75$ V	tbf	3.35	tbf	V
		$V_{CCA} = 5.25$ V	tbf	3.85	tbf	V

# 10-bit high-speed Analog-to-Digital Converter (ADC)

TDA8765

SYMBOL	PARAMETER	CONDITIONS	MIN.	TYP.	MAX.	UNIT
<b>Voltage controlled regulator input <math>V_{ref}</math> (referenced to AGND); note 2</b>						
$V_{ref}$	full-scale fixed voltage	$V_{CCA} = 5\text{ V}$	–	3.175	–	V
$V_{I(p-p)} - \bar{V}_{I(p-p)}$	input voltage amplitude (peak-to-peak value)	$V_{ref} = V_{CCA} - 1.825\text{ V}$	–	2.0	–	V
$I_{ref}$	input current at $V_{ref}$		–	0.5	10	$\mu\text{A}$
<b>Outputs (referenced to OGND)</b>						
DIGITAL OUTPUTS D11 TO D0 AND IR (REFERENCED TO OGND)						
$V_{OL}$	LOW-level output voltage	$I_{OL} = 2\text{ mA}$	0	–	0.5	V
$V_{OH}$	HIGH-level output voltage	$I_{OH} = -0.4\text{ mA}$	$V_{CCO} - 0.5$	–	$V_{CCO}$	V
$I_o$	output current in 3-state	output level between 0.5 V and $V_{CCO}$	–20	–	+20	$\mu\text{A}$
<b>Switching characteristics</b>						
CLOCK FREQUENCY $f_{CLK}$ ; see Fig.5						
$f_{CLK(min)}$	minimum clock frequency	SH = HIGH	–	–	1	MHz
		SH = LOW	–	–	1	kHz
$f_{CLK(max)}$	maximum clock frequency	TDA8765H/4	40	–	–	MHz
		TDA8765H/5	55	–	–	MHz
$t_{CLKH}$	clock pulse width HIGH		8.5	–	–	ns
$t_{CLKL}$	clock pulse width LOW		8.5	–	–	ns
<b>Analog signal processing; 50% clock duty factor; <math>V_I - \bar{V}_I = 2.0\text{ V}</math>; <math>V_{ref} = V_{CCA} - 1.825\text{ V}</math>; see Table 1</b>						
LINEARITY						
INL	integral non-linearity	$f_{CLK} = 4\text{ MHz}$ ; $f_i = 400\text{ kHz}$	–	$\pm 0.5$	$\pm 1.75$	LSB
DNL	differential non-linearity	$f_{CLK} = 4\text{ MHz}$ ; $f_i = 400\text{ kHz}$ ; no missing code	–	$\pm 0.3$	$\pm 0.5$	LSB
$E_{offset}$	offset error	$V_{CCA} = V_{CCD} = V_{CCO} = 5\text{ V}$ ; $T_{amb} = 25\text{ }^\circ\text{C}$ ; $V_I = \bar{V}_I$ ; output code = 511	tbf	–11	tbf	mV
$E_G$	gain error amplitude; spread from device to device	$V_{CCA} = V_{CCD} = V_{CCO} = 5\text{ V}$ ; $T_{amb} = 25\text{ }^\circ\text{C}$ ; $V_{I(p-p)} - \bar{V}_{I(p-p)} = 2.0\text{ V}$	–5	–	+5	%FS
BANDWIDTH ( $f_{CLK} = 55\text{ MHz}$ ); note 3						
B	analog bandwidth	–3 dB; full-scale input	tbf	200	–	MHz



# 10-bit high-speed Analog-to-Digital Converter (ADC)

TDA8765

SYMBOL	PARAMETER	CONDITIONS	MIN.	TYP.	MAX.	UNIT
HARMONICS ( $f_{CLK} = 40$ MHz)						
$H_{fund(FS)}$	fundamental harmonics (full scale)	$f_i = 4.43$ MHz	–	–	0	dB
$H_{tot(FS)}$	harmonics (full scale); all components	$f_i = 4.43$ MHz				
	second harmonic		–	–75	–	dB
	third harmonic		–	–70	–	dB
THD	total harmonic distortion	$f_i = 4.43$ MHz; note 4	–	–66	–	dB
THERMAL NOISE						
$N_{th(rms)}$	thermal noise (RMS value)	grounded input; $f_{CLK} = 40$ MHz	–	0.2	tbf	LSB
SPURIOUS FREE DYNAMIC RANGE						
$DR_{sf}$	spurious free dynamic range	$f_i = 4.43$ MHz	tbf	71	–	dB
		$f_i = 10$ MHz	tbf	68	–	dB
		$f_i = 20$ MHz	tbf	67	–	dB
SIGNAL-TO-NOISE RATIO; note 5						
S/N	signal-to-noise ratio	without harmonics; $f_{CLK} = 40$ MHz; $f_i = 4.43$ MHz	–	59	–	dB
EFFECTIVE NUMBER OF BITS; see Figs 3 and 4 and note 5						
$N_{bit}$	effective number of bits TDA8765H/4 ( $f_{CLK} = 40$ MHz)	$f_i = 4.43$ MHz	9.0	9.6	–	bits
		$f_i = 10$ MHz	–	9.6	–	bits
		$f_i = 15$ MHz	–	9.5	–	bits
	effective number of bits TDA8765H/5 ( $f_{CLK} = 55$ MHz)	$f_i = 4.43$ MHz	–	9.6	–	bits
		$f_i = 10$ MHz	–	9.4	–	bits
		$f_i = 15$ MHz	–	9.3	–	bits
		$f_i = 20$ MHz	–	9.1	–	bits
INTERMODULATION; note 6						
TTIR	two-tone intermodulation rejection	$f_{CLK} = 40$ MHz	tbf	66	–	dB
$d_3$	third-order intermodulation distortion	$f_{CLK} = 40$ MHz	tbf	67	–	dB
BIT ERROR RATE						
BER	bit error rate	$f_{CLK} = 40$ MHz; $f_i = 4.43$ MHz; $V_1 = \pm 16$ LSB at code 511	–	$10^{-15}$	tbf	times/sample

# 10-bit high-speed Analog-to-Digital Converter (ADC)

TDA8765

SYMBOL	PARAMETER	CONDITIONS	MIN.	TYP.	MAX.	UNIT
<b>Timing (<math>C_L = 10</math> pF); see Fig.5 and note 7</b>						
$t_{d(s)}$	sampling delay time		–	–	2	ns
$t_h$	output hold time		4	–	–	ns
$t_d$	output delay time	$V_{CCO} = 5.25$ V	–	10	15	ns
		$V_{CCO} = 3.0$ V	–	13	18	ns
<b>3-state output delay times; see Fig.6</b>						
$t_{dZH}$	enable HIGH		–	14	18	ns
$t_{dZL}$	enable LOW		–	16	20	ns
$t_{dHZ}$	disable HIGH		–	16	20	ns
$t_{dLZ}$	disable LOW		–	14	18	ns

## Notes

- The circuit has two clock inputs: CLK and  $\overline{CLK}$ . There are four modes of operation:
  - PECL mode 1 (DC level varies equal to DC level of  $V_{CCD}$ ): CLK and  $\overline{CLK}$  inputs are at differential PECL levels.
  - PECL mode 2 (DC level varies equal to DC level of  $V_{CCD}$ ): CLK input is at PECL level and sampling is taken on the falling edge of the clock input signal. A DC level of 3.65 V has to be applied on  $\overline{CLK}$  decoupled to GND via a 100 nF capacitor.
  - PECL mode 3 (DC level varies equal to DC level of  $V_{CCD}$ ):  $\overline{CLK}$  input is at PECL level and sampling is taken on the rising edge of the clock input signal. A DC level of 3.65 V has to be applied on CLK decoupled to GND via a 100 nF capacitor.
  - AC driving mode 4: when driving the CLK input directly and with any AC signal of minimum 0.5 V (p-p) and with a DC level of 2.5 V, the sampling takes place at the falling edge of the clock signal.  
When driving the  $\overline{CLK}$  input with the same signal, sampling takes place at the rising edge of the clock signal. It is recommended to decouple the  $\overline{CLK}$  or CLK input to DGND via a 100 nF capacitor.
- It is possible with an external reference connected to pin  $V_{ref}$  to adjust the ADC input range. This voltage has to be referenced to  $V_{CCA}$ . For  $V_{CCA} = 1.825$  V, the differential input voltage amplitude is 2 V (p-p).
- The –3 dB analog bandwidth is determined by the 3 dB reduction in the reconstructed output, the input being a full-scale sine wave.
- THD (total harmonic distortion) is obtained with the addition of the first five harmonics:
 
$$THD = 20 \log \frac{F}{\sqrt{(2nd)^2 + (3rd)^2 + (4th)^2 + (5th)^2 + (6th)^2}}$$
 where F is the fundamental harmonic referenced at 0 dB for a full-scale sine wave input.
- Effective number of bits are obtained via a Fast Fourier Transform (FFT). The calculation takes into account all harmonics and noise up to half of the clock frequency (Nyquist frequency). Conversion to SNR:  
 $SNR = N_{bit} \times 6.02 + 1.76$  dB.
- Intermodulation measured relative to either tone with analog input frequencies of 4.43 and 4.53 MHz. The two input signals have the same amplitude and the total amplitude of both signals provides full-scale to the converter (–6 dB below full scale for each input signal).  
 $d_3$  is the ratio of the RMS-value of either input tone to the RMS-value of the worst case third order intermodulation product.
- Output data acquisition: the output data is available after the maximum delay of  $t_d$ .

# 10-bit high-speed Analog-to-Digital Converter (ADC)

TDA8765

**Table 1** Output coding with differential inputs (typical values to AGND);  $V_{i(p-p)} - \bar{V}_{i(p-p)} = 2.0\text{ V}$ ;  $V_{ref} = V_{CCA} - 1.825\text{ V}$

CODE	$V_{i(p-p)}$	$\bar{V}_{i(p-p)}$	IR	BINARY OUTPUTS	TWOS COMPLEMENT OUTPUTS
				D9 TO D0	D9 TO D0
Underflow	<3.1	>4.1	0	0 0 0 0 0 0 0 0 0 0	1 0 0 0 0 0 0 0 0 0
0	3.1	4.1	1	0 0 0 0 0 0 0 0 0 0	1 0 0 0 0 0 0 0 0 0
1	–	–	1	0 0 0 0 0 0 0 0 0 1	1 0 0 0 0 0 0 0 0 1
↓	–	–	↓	↓	↓
511	3.6	3.6	1	0 1 1 1 1 1 1 1 1 1	1 1 1 1 1 1 1 1 1 1
↓	–	–	↓	↓	↓
1022	–	–	1	1 1 1 1 1 1 1 1 1 0	0 1 1 1 1 1 1 1 1 0
1023	4.1	3.1	1	1 1 1 1 1 1 1 1 1 1	0 1 1 1 1 1 1 1 1 1
Overflow	>4.1	<3.1	0	1 1 1 1 1 1 1 1 1 1	0 1 1 1 1 1 1 1 1 1

**Table 2** Mode selection

OTC	$\overline{CE}$	D0 TO D9 AND IR
0	0	binary; active
1	0	twos complement; active
X <sup>(1)</sup>	1	high impedance

**Note**

1. X = don't care.

**Table 3** Sample-and-hold selection

SH	SAMPLE-AND-HOLD
1	active
0	inactive; tracking mode

10-bit high-speed Analog-to-Digital Converter (ADC)

TDA8765

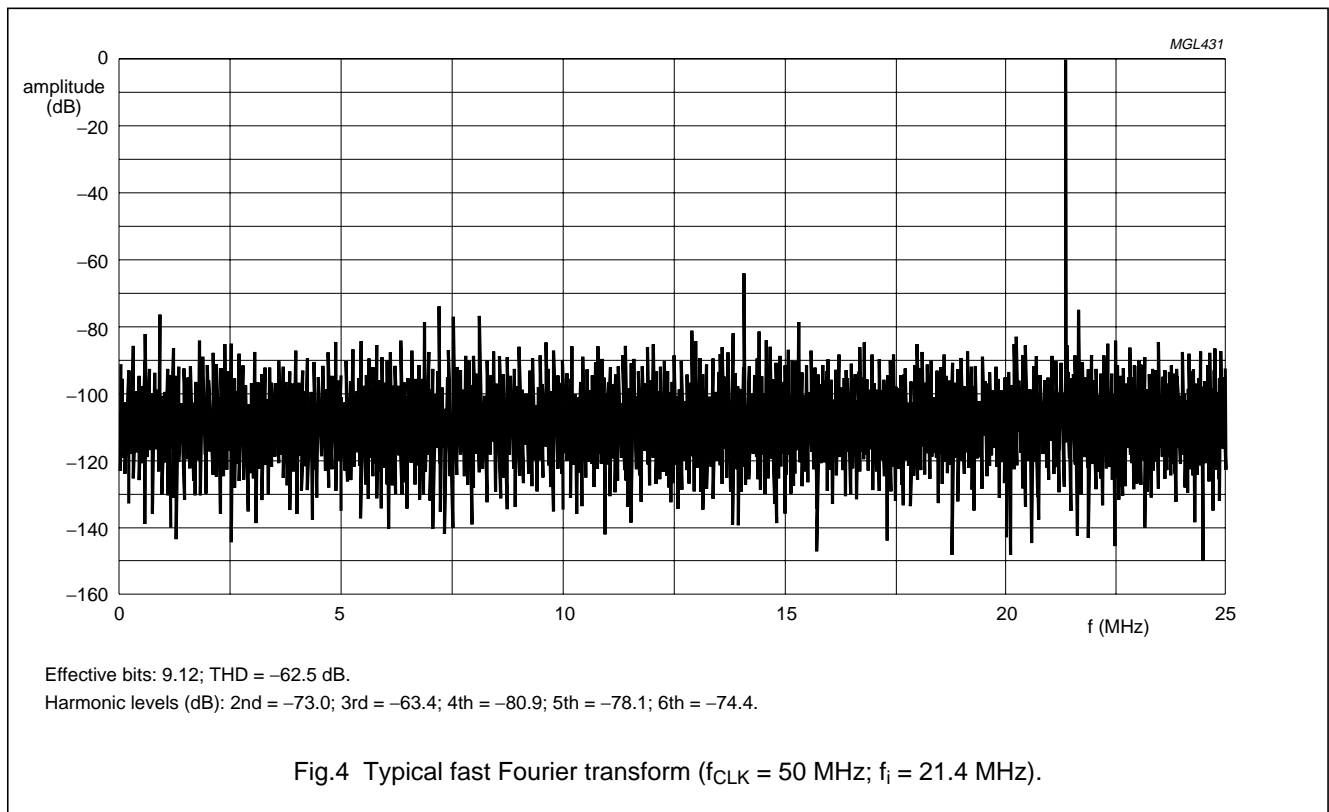
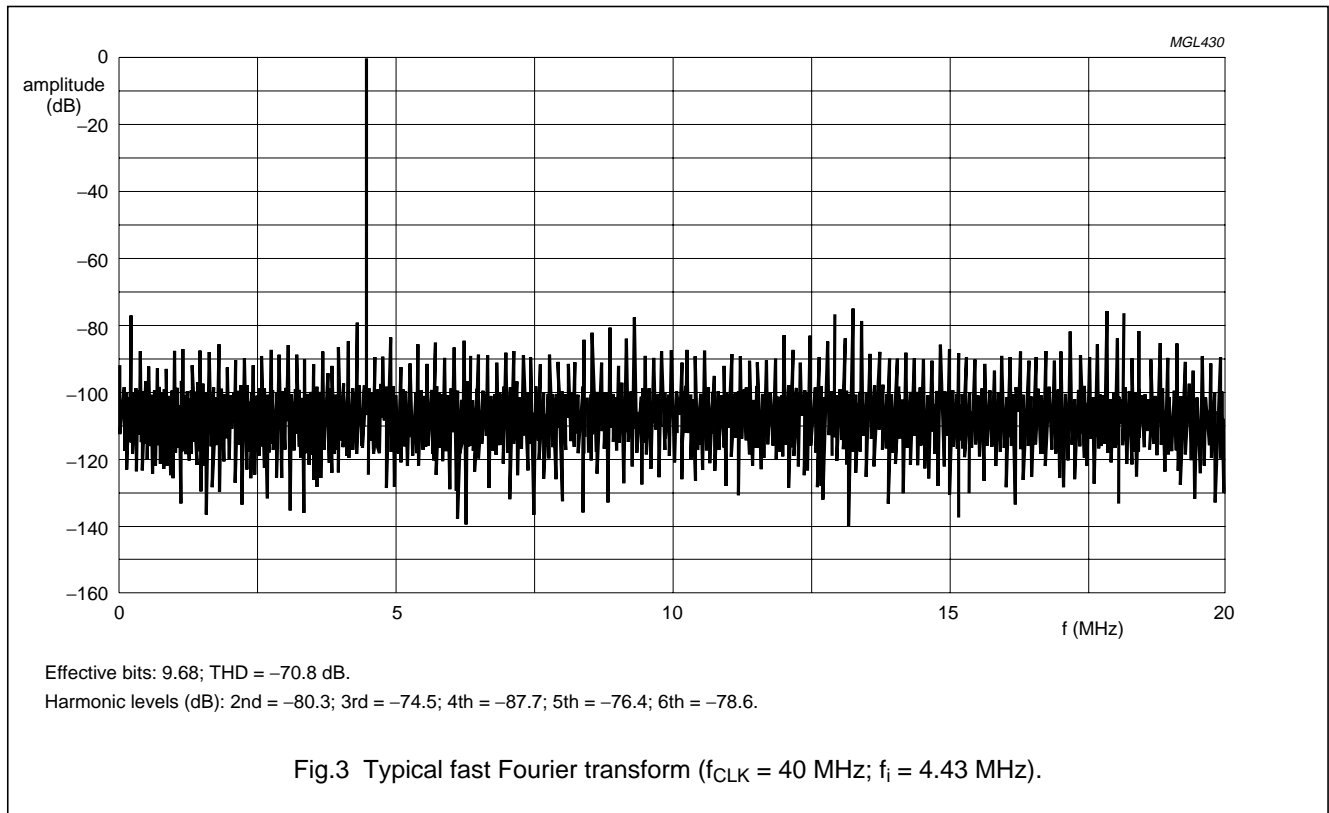

# 10-bit high-speed Analog-to-Digital Converter (ADC)

TDA8765

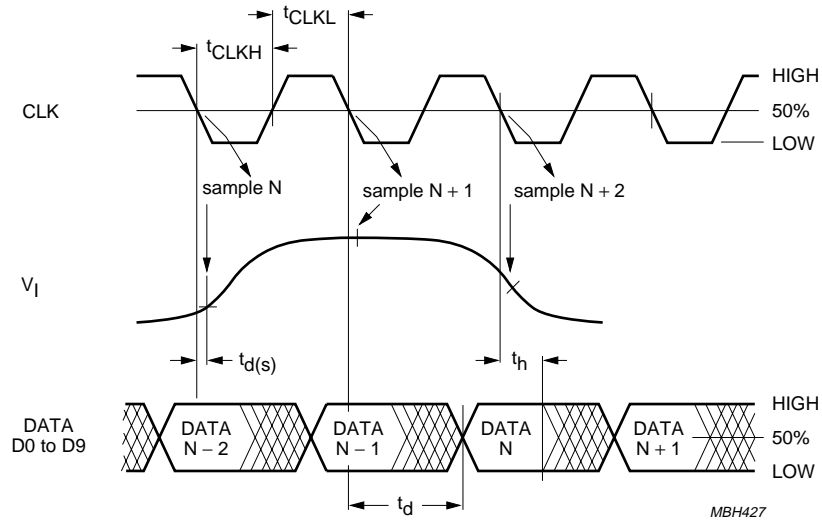
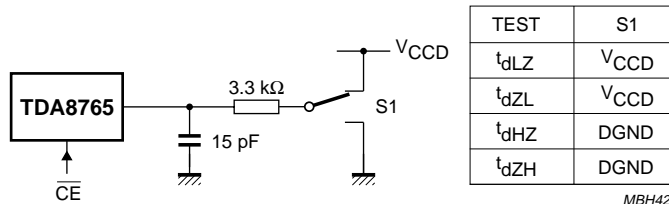
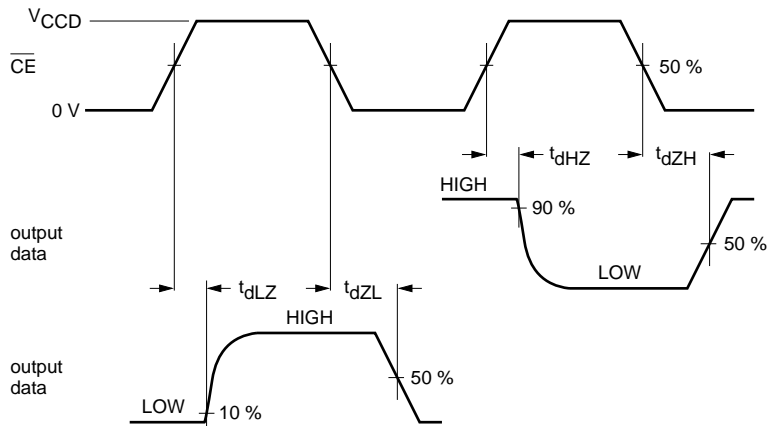

Fig.5 Timing diagram.



TEST	S1
t <sub>dLZ</sub>	V <sub>CCD</sub>
t <sub>dZL</sub>	V <sub>CCD</sub>
t <sub>dHZ</sub>	DGND
t <sub>dZH</sub>	DGND

f<sub>CE</sub> = 100 kHz.

Fig.6 Timing diagram and test conditions of 3-state output delay time.



# 10-bit high-speed Analog-to-Digital Converter (ADC)

TDA8765

## PACKAGE OUTLINE

QFP44: plastic quad flat package; 44 leads (lead length 1.3 mm); body 10 x 10 x 1.75 mm

SOT307-2

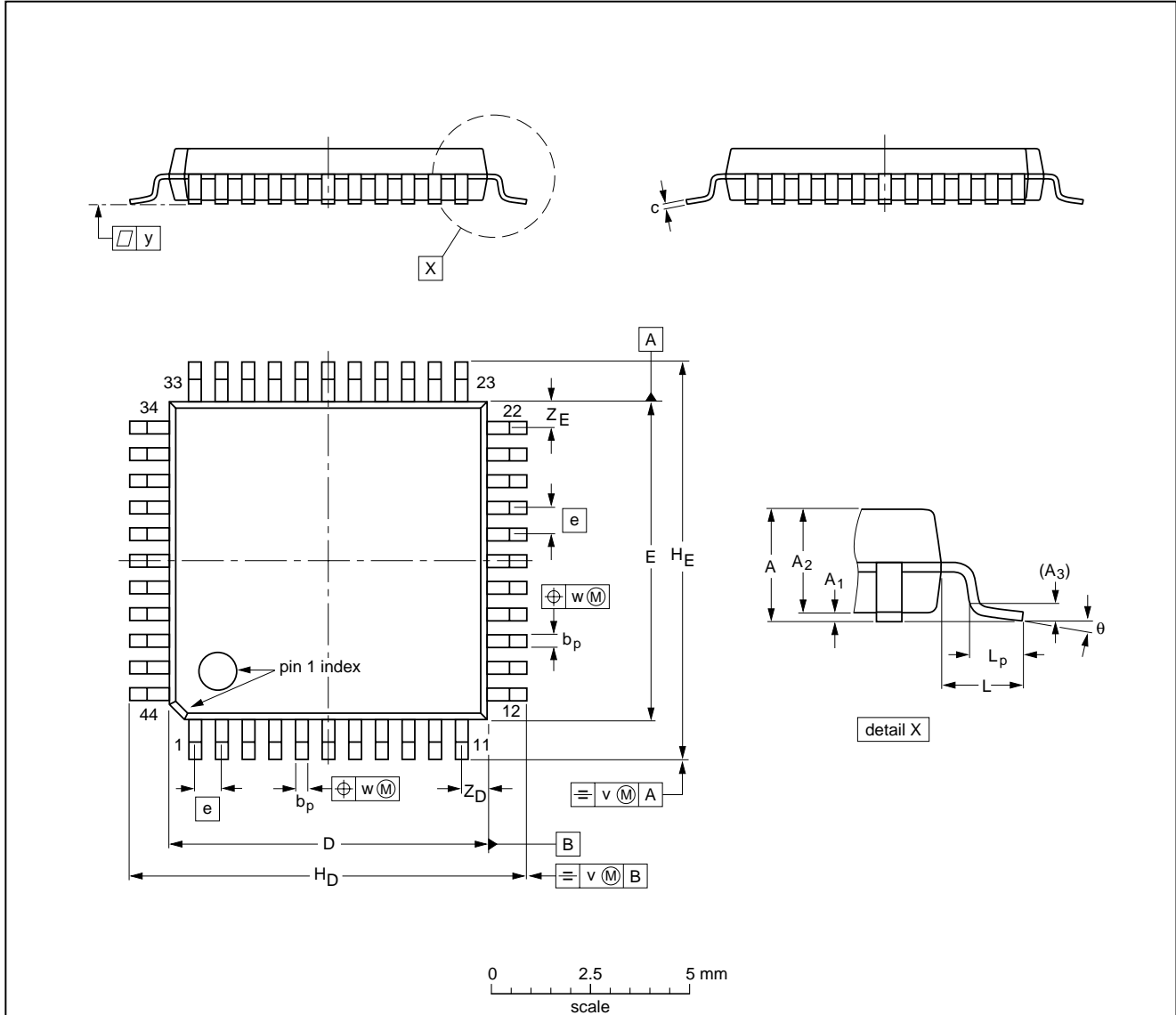

**DIMENSIONS (mm are the original dimensions)**

UNIT	A max.	A <sub>1</sub>	A <sub>2</sub>	A <sub>3</sub>	b <sub>p</sub>	c	D <sup>(1)</sup>	E <sup>(1)</sup>	e	H <sub>D</sub>	H <sub>E</sub>	L	L <sub>p</sub>	v	w	y	Z <sub>D</sub> <sup>(1)</sup>	Z <sub>E</sub> <sup>(1)</sup>	θ
mm	2.10	0.25 0.05	1.85 1.65	0.25	0.40 0.20	0.25 0.14	10.1 9.9	10.1 9.9	0.8	12.9 12.3	12.9 12.3	1.3	0.95 0.55	0.15	0.15	0.1	1.2 0.8	1.2 0.8	10° 0°

**Note**

1. Plastic or metal protrusions of 0.25 mm maximum per side are not included.

OUTLINE VERSION	REFERENCES				EUROPEAN PROJECTION	ISSUE DATE
	IEC	JEDEC	EIAJ			
SOT307-2						95-02-04 97-08-01

## 10-bit high-speed Analog-to-Digital Converter (ADC)

TDA8765

### SOLDERING

#### Introduction to soldering surface mount packages

This text gives a very brief insight to a complex technology. A more in-depth account of soldering ICs can be found in our *"Data Handbook IC26; Integrated Circuit Packages"* (document order number 9398 652 90011).

There is no soldering method that is ideal for all surface mount IC packages. Wave soldering is not always suitable for surface mount ICs, or for printed-circuit boards with high population densities. In these situations reflow soldering is often used.

#### Reflow soldering

Reflow soldering requires solder paste (a suspension of fine solder particles, flux and binding agent) to be applied to the printed-circuit board by screen printing, stencilling or pressure-syringe dispensing before package placement.

Several methods exist for reflowing; for example, infrared/convection heating in a conveyor type oven. Throughput times (preheating, soldering and cooling) vary between 100 and 200 seconds depending on heating method.

Typical reflow peak temperatures range from 215 to 250 °C. The top-surface temperature of the packages should preferably be kept below 230 °C.

#### Wave soldering

Conventional single wave soldering is not recommended for surface mount devices (SMDs) or printed-circuit boards with a high component density, as solder bridging and non-wetting can present major problems.

To overcome these problems the double-wave soldering method was specifically developed.

If wave soldering is used the following conditions must be observed for optimal results:

- Use a double-wave soldering method comprising a turbulent wave with high upward pressure followed by a smooth laminar wave.
- For packages with leads on two sides and a pitch (e):
  - larger than or equal to 1.27 mm, the footprint longitudinal axis is **preferred** to be parallel to the transport direction of the printed-circuit board;
  - smaller than 1.27 mm, the footprint longitudinal axis **must** be parallel to the transport direction of the printed-circuit board.

The footprint must incorporate solder thieves at the downstream end.

- For packages with leads on four sides, the footprint must be placed at a 45° angle to the transport direction of the printed-circuit board. The footprint must incorporate solder thieves downstream and at the side corners.

During placement and before soldering, the package must be fixed with a droplet of adhesive. The adhesive can be applied by screen printing, pin transfer or syringe dispensing. The package can be soldered after the adhesive is cured.

Typical dwell time is 4 seconds at 250 °C. A mildly-activated flux will eliminate the need for removal of corrosive residues in most applications.

#### Manual soldering

Fix the component by first soldering two diagonally-opposite end leads. Use a low voltage (24 V or less) soldering iron applied to the flat part of the lead. Contact time must be limited to 10 seconds at up to 300 °C.

When using a dedicated tool, all other leads can be soldered in one operation within 2 to 5 seconds between 270 and 320 °C.



# 10-bit high-speed Analog-to-Digital Converter (ADC)

TDA8765

## Suitability of surface mount IC packages for wave and reflow soldering methods

PACKAGE	SOLDERING METHOD	
	WAVE	REFLOW <sup>(1)</sup>
BGA, SQFP	not suitable	suitable
HLQFP, HSQFP, HSOP, HTSSOP, SMS	not suitable <sup>(2)</sup>	suitable
PLCC <sup>(3)</sup> , SO, SOJ	suitable	suitable
LQFP, QFP, TQFP	not recommended <sup>(3)(4)</sup>	suitable
SSOP, TSSOP, VSO	not recommended <sup>(5)</sup>	suitable

### Notes

- All surface mount (SMD) packages are moisture sensitive. Depending upon the moisture content, the maximum temperature (with respect to time) and body size of the package, there is a risk that internal or external package cracks may occur due to vaporization of the moisture in them (the so called popcorn effect). For details, refer to the Drypack information in the "Data Handbook IC26; Integrated Circuit Packages; Section: Packing Methods".
- These packages are not suitable for wave soldering as a solder joint between the printed-circuit board and heatsink (at bottom version) can not be achieved, and as solder may stick to the heatsink (on top version).
- If wave soldering is considered, then the package must be placed at a 45° angle to the solder wave direction. The package footprint must incorporate solder thieves downstream and at the side corners.
- Wave soldering is only suitable for LQFP, TQFP and QFP packages with a pitch (e) equal to or larger than 0.8 mm; it is definitely not suitable for packages with a pitch (e) equal to or smaller than 0.65 mm.
- Wave soldering is only suitable for SSOP and TSSOP packages with a pitch (e) equal to or larger than 0.65 mm; it is definitely not suitable for packages with a pitch (e) equal to or smaller than 0.5 mm.

### DEFINITIONS

Data sheet status	
Objective specification	This data sheet contains target or goal specifications for product development.
Preliminary specification	This data sheet contains preliminary data; supplementary data may be published later.
Product specification	This data sheet contains final product specifications.
Limiting values	
Limiting values given are in accordance with the Absolute Maximum Rating System (IEC 134). Stress above one or more of the limiting values may cause permanent damage to the device. These are stress ratings only and operation of the device at these or at any other conditions above those given in the Characteristics sections of the specification is not implied. Exposure to limiting values for extended periods may affect device reliability.	
Application information	
Where application information is given, it is advisory and does not form part of the specification.	

### LIFE SUPPORT APPLICATIONS

These products are not designed for use in life support appliances, devices, or systems where malfunction of these products can reasonably be expected to result in personal injury. Philips customers using or selling these products for use in such applications do so at their own risk and agree to fully indemnify Philips for any damages resulting from such improper use or sale.

---

10-bit high-speed Analog-to-Digital  
Converter (ADC)

---

TDA8765

**NOTES**

---

10-bit high-speed Analog-to-Digital  
Converter (ADC)

---

TDA8765

**NOTES**

# Philips Semiconductors – a worldwide company

**Argentina:** see South America

**Australia:** 34 Waterloo Road, NORTH RYDE, NSW 2113,  
Tel. +61 2 9805 4455, Fax. +61 2 9805 4466

**Austria:** Computerstr. 6, A-1101 WIEN, P.O. Box 213,  
Tel. +43 1 60 101 1248, Fax. +43 1 60 101 1210

**Belarus:** Hotel Minsk Business Center, Bld. 3, r. 1211, Volodarski Str. 6,  
220050 MINSK, Tel. +375 172 20 0733, Fax. +375 172 20 0773

**Belgium:** see The Netherlands

**Brazil:** see South America

**Bulgaria:** Philips Bulgaria Ltd., Energoproject, 15th floor,  
51 James Bourchier Blvd., 1407 SOFIA,  
Tel. +359 2 68 9211, Fax. +359 2 68 9102

**Canada:** PHILIPS SEMICONDUCTORS/COMPONENTS,  
Tel. +1 800 234 7381, Fax. +1 800 943 0087

**China/Hong Kong:** 501 Hong Kong Industrial Technology Centre,  
72 Tat Chee Avenue, Kowloon Tong, HONG KONG,  
Tel. +852 2319 7888, Fax. +852 2319 7700

**Colombia:** see South America

**Czech Republic:** see Austria

**Denmark:** Sydhavnsgade 23, 1780 COPENHAGEN V,  
Tel. +45 33 29 3333, Fax. +45 33 29 3905

**Finland:** Sinikalliontie 3, FIN-02630 ESPOO,  
Tel. +358 9 615 800, Fax. +358 9 6158 0920

**France:** 51 Rue Carnot, BP317, 92156 SURESNES Cedex,  
Tel. +33 1 4099 6161, Fax. +33 1 4099 6427

**Germany:** Hammerbrookstraße 69, D-20097 HAMBURG,  
Tel. +49 40 2353 60, Fax. +49 40 2353 6300

**Greece:** No. 15, 25th March Street, GR 17778 TAVROS/ATHENS,  
Tel. +30 1 489 4339/4239, Fax. +30 1 481 4240

**Hungary:** see Austria

**India:** Philips INDIA Ltd, Band Box Building, 2nd floor,  
254-D, Dr. Annie Besant Road, Worli, MUMBAI 400 025,  
Tel. +91 22 493 8541, Fax. +91 22 493 0966

**Indonesia:** PT Philips Development Corporation, Semiconductors Division,  
Gedung Philips, Jl. Buncit Raya Kav.99-100, JAKARTA 12510,  
Tel. +62 21 794 0040 ext. 2501, Fax. +62 21 794 0080

**Ireland:** Newstead, Clonskeagh, DUBLIN 14,  
Tel. +353 1 7640 000, Fax. +353 1 7640 200

**Israel:** RAPAC Electronics, 7 Kehilat Saloniki St, PO Box 18053,  
TEL AVIV 61180, Tel. +972 3 645 0444, Fax. +972 3 649 1007

**Italy:** PHILIPS SEMICONDUCTORS, Piazza IV Novembre 3,  
20124 MILANO, Tel. +39 2 6752 2531, Fax. +39 2 6752 2557

**Japan:** Philips Bldg 13-37, Kohnan 2-chome, Minato-ku,  
TOKYO 108-8507, Tel. +81 3 3740 5130, Fax. +81 3 3740 5077

**Korea:** Philips House, 260-199 Itaewon-dong, Yongsan-ku, SEOUL,  
Tel. +82 2 709 1412, Fax. +82 2 709 1415

**Malaysia:** No. 76 Jalan Universiti, 46200 PETALING JAYA, SELANGOR,  
Tel. +60 3 750 5214, Fax. +60 3 757 4880

**Mexico:** 5900 Gateway East, Suite 200, EL PASO, TEXAS 79905,  
Tel. +9-5 800 234 7381, Fax +9-5 800 943 0087

**Middle East:** see Italy

**Netherlands:** Postbus 90050, 5600 PB EINDHOVEN, Bldg. VB,  
Tel. +31 40 27 82785, Fax. +31 40 27 88399

**New Zealand:** 2 Wagener Place, C.P.O. Box 1041, AUCKLAND,  
Tel. +64 9 849 4160, Fax. +64 9 849 7811

**Norway:** Box 1, Manglerud 0612, OSLO,  
Tel. +47 22 74 8000, Fax. +47 22 74 8341

**Pakistan:** see Singapore

**Philippines:** Philips Semiconductors Philippines Inc.,  
106 Valero St. Salcedo Village, P.O. Box 2108 MCC, MAKATI,  
Metro MANILA, Tel. +63 2 816 6380, Fax. +63 2 817 3474

**Poland:** Ul. Lukiska 10, PL 04-123 WARSZAWA,  
Tel. +48 22 612 2831, Fax. +48 22 612 2327

**Portugal:** see Spain

**Romania:** see Italy

**Russia:** Philips Russia, Ul. Usatcheva 35A, 119048 MOSCOW,  
Tel. +7 095 755 6918, Fax. +7 095 755 6919

**Singapore:** Lorong 1, Toa Payoh, SINGAPORE 319762,  
Tel. +65 350 2538, Fax. +65 251 6500

**Slovakia:** see Austria

**Slovenia:** see Italy

**South Africa:** S.A. PHILIPS Pty Ltd., 195-215 Main Road Martindale,  
2092 JOHANNESBURG, P.O. Box 7430 Johannesburg 2000,  
Tel. +27 11 470 5911, Fax. +27 11 470 5494

**South America:** Al. Vicente Pinzon, 173, 6th floor,  
04547-130 SÃO PAULO, SP, Brazil,  
Tel. +55 11 821 2333, Fax. +55 11 821 2382

**Spain:** Balmes 22, 08007 BARCELONA,  
Tel. +34 93 301 6312, Fax. +34 93 301 4107

**Sweden:** Kottbygatan 7, Akalla, S-16485 STOCKHOLM,  
Tel. +46 8 5985 2000, Fax. +46 8 5985 2745

**Switzerland:** Allmendstrasse 140, CH-8027 ZÜRICH,  
Tel. +41 1 488 2741 Fax. +41 1 488 3263

**Taiwan:** Philips Semiconductors, 6F, No. 96, Chien Kuo N. Rd., Sec. 1,  
TAIPEI, Taiwan Tel. +886 2 2134 2865, Fax. +886 2 2134 2874

**Thailand:** PHILIPS ELECTRONICS (THAILAND) Ltd.,  
209/2 Sanpavuth-Bangna Road Prakanong, BANGKOK 10260,  
Tel. +66 2 745 4090, Fax. +66 2 398 0793

**Turkey:** Talatpasa Cad. No. 5, 80640 GÜLTEPE/ISTANBUL,  
Tel. +90 212 279 2770, Fax. +90 212 282 6707

**Ukraine:** PHILIPS UKRAINE, 4 Patrice Lumumba str., Building B, Floor 7,  
252042 KIEV, Tel. +380 44 264 2776, Fax. +380 44 268 0461

**United Kingdom:** Philips Semiconductors Ltd., 276 Bath Road, Hayes,  
MIDDLESEX UB3 5BX, Tel. +44 181 730 5000, Fax. +44 181 754 8421

**United States:** 811 East Arques Avenue, SUNNYVALE, CA 94088-3409,  
Tel. +1 800 234 7381, Fax. +1 800 943 0087

**Uruguay:** see South America

**Vietnam:** see Singapore

**Yugoslavia:** PHILIPS, Trg N. Pasica 5/v, 11000 BEOGRAD,  
Tel. +381 11 62 5344, Fax. +381 11 63 5777

**For all other countries apply to:** Philips Semiconductors,  
International Marketing & Sales Communications, Building BE-p, P.O. Box 218,  
5600 MD EINDHOVEN, The Netherlands, Fax. +31 40 27 24825

**Internet:** <http://www.semiconductors.philips.com>

© Philips Electronics N.V. 1999

SCA61

All rights are reserved. Reproduction in whole or in part is prohibited without the prior written consent of the copyright owner.

The information presented in this document does not form part of any quotation or contract, is believed to be accurate and reliable and may be changed without notice. No liability will be accepted by the publisher for any consequence of its use. Publication thereof does not convey nor imply any license under patent- or other industrial or intellectual property rights.

Printed in The Netherlands

545104/750/02/pp20

Date of release: 1999 Jan 06

Document order number: 9397 750 04716

*Let's make things better.*

**Philips  
Semiconductors**



**PHILIPS**