

# DENON

## DOUBLE CD PLAYER

# DN-D9000

## OPERATING INSTRUCTIONS

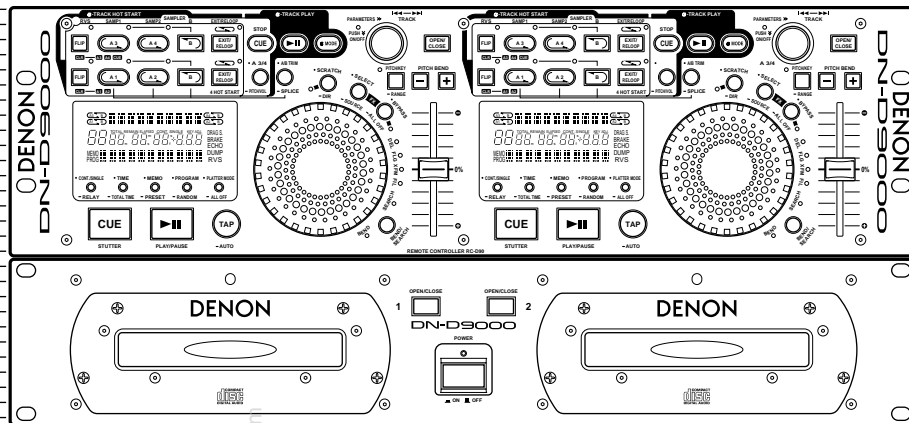



**CAUTION**  
**RISK OF ELECTRIC SHOCK**  
**DO NOT OPEN**



**CAUTION: TO REDUCE THE RISK OF ELECTRIC SHOCK, DO NOT REMOVE COVER (OR BACK). NO USER SERVICEABLE PARTS INSIDE. REFER SERVICING TO QUALIFIED SERVICE PERSONNEL.**



The lightning flash with arrowhead symbol, within an equilateral triangle, is intended to alert the user to the presence of uninsulated "dangerous voltage" within the product's enclosure that may be of sufficient magnitude to constitute a risk of electric shock to persons.



The exclamation point within an equilateral triangle is intended to alert the user to the presence of important operating and maintenance (servicing) instructions in the literature accompanying the appliance.

**WARNING: TO PREVENT FIRE OR SHOCK HAZARD, DO NOT EXPOSE THIS APPLIANCE TO RAIN OR MOISTURE.**

**CAUTION:**

**1. Handle the power supply cord carefully**

Do not damage or deform the power supply cord. If it is damaged or deformed, it may cause electric shock or malfunction when used. When removing from wall outlet, be sure to remove by holding the plug attachment and not by pulling the cord.

**2. Do not open the top cover**

In order to prevent electric shock, do not open the top cover. If problems occur, contact your DENON dealer.

**3. Do not place anything inside**

Do not place metal objects or spill liquid inside the CD player. Electric shock or malfunction may result.

Please, record and retain the Model name and serial number of your set shown on the rating label.

Model No. DN-D9000 Serial No. \_\_\_\_\_

**NOTE:**

This CD player uses the semiconductor laser. To allow you to enjoy music at a stable operation, it is recommended to use this in a room of 5 °C (41 °F) -35 °C (95 °F).

**CLASS 1 LASER PRODUCT**  
**LUOKAN 1 LASERLAITE**  
**KLASS 1 LASERAPPARAT**

**"CLASS 1 LASER PRODUCT"**

**ADVARSEL:** USYNLIG LASERSTRÅLING VED ÅBNING, NÅR SIKKERHEDSAFBRYDERE ER UDE AF FUNKTION. UNDGÅ UDSÆTTELSE FOR STRÅLING.

**VAROITUS!** LAITTEEN KÄYTTÄMINEN MUULLA KUIN TÄSSÄ KÄYTTÖOHJEESSA MAINITULLA TAVALLA SAATTAÄ ALTISTAA KÄYTTÄJÄN TURVALLISUUSLUOKAN 1 YLITTÄVÄLLE NÄKYMÄMTTÖMÄLLE LASERSÄTEILYLLE.

**WARNING-** OM APPARATEN ANVÄNDS PÅ ANNAT SÄTT ÄN I DENNA BRUKSANVISNING SPECIFICERATS, KAN ANVÄNDAREN UTSÄTTAS FÖR OSYNLIG LASERSTRÅLNING SOM ÖVERSKRIDER GRÄNSEN FÖR LASERKLASS 1.

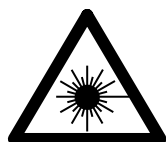

**LABELS** (for U.S.A. model only)

**CERTIFICATION**

THIS PRODUCT COMPLIES WITH DHHS RULES 21 CFR SUBCHAPTER J APPLICABLE AT DATE OF MANUFACTURE.

**CAUTION:**

**USE OF CONTROLS OR ADJUSTMENTS OR PERFORMANCE OF PROCEDURES OTHER THAN THOSE SPECIFIED HEREIN MAY RESULT IN HAZARDOUS RADIATION EXPOSURE.**

**THE COMPACT DISC PLAYER SHOULD NOT BE ADJUSTED OR REPAIRED BY ANYONE EXCEPT PROPERLY QUALIFIED SERVICE PERSONNEL.**

This device complies with Part 15 of the FCC Rules. Operation is subject to the following two conditions : (1) This device may not cause harmful interference, and (2) this device must accept any interference received, including interference that may cause undesired operation.

This Class B digital apparatus meets all requirements of the Canadian Interference-Causing Equipment Regulations.

Cet appareil numérique de la classe B respecte toutes les exigences du Règlement sur le matériel brouilleur du Canada.

**SAFETY INSTRUCTIONS**

1. Read Instructions – All the safety and operating instructions should be read before the product is operated.
2. Retain Instructions – The safety and operating instructions should be retained for future reference.
3. Heed Warnings – All warnings on the product and in the operating instructions should be adhered to.
4. Follow Instructions – All operating and use instructions should be followed.
5. Cleaning – Unplug this product from the wall outlet before cleaning. Do not use liquid cleaners or aerosol cleaners.
6. Attachments – Do not use attachments not recommended by the product manufacturer as they may cause hazards.
7. Water and Moisture – Do not use this product near water – for example, near a bath tub, wash bowl, kitchen sink, or laundry tub; in a wet basement; or near a swimming pool; and the like.
8. Accessories – Do not place this product on an unstable cart, stand, tripod, bracket, or table. The product may fall, causing serious injury to a child or adult, and serious damage to the product. Use only with a cart, stand, tripod, bracket, or table recommended by the manufacturer, or sold with the product. Any mounting of the product should follow the manufacturer's instructions, and should use a mounting accessory recommended by the manufacturer.
9. A product and cart combination should be moved with care. Quick stops, excessive force, and uneven surfaces may cause the product and cart combination to overturn.
10. Ventilation – Slots and openings in the cabinet are provided for ventilation and to ensure reliable operation of the product and to protect it from overheating, and these openings must not be blocked or covered. The openings should never be blocked by placing the product on a bed, sofa, rug, or other similar surface. This product should not be placed in a built-in installation such as a bookcase or rack unless proper ventilation is provided or the manufacturer's instructions have been adhered to.
11. Power Sources – This product should be operated only from the type of power source indicated on the marking label. If you are not sure of the type of power supply to your home, consult your product dealer or local power company. For products intended to operate from battery power, or other sources, refer to the operating instructions.
12. Grounding or Polarization – This product may be equipped with a polarized alternating-current line plug (a plug having one blade wider than the other). This plug will fit into the power outlet only one way. This is a safety feature. If you are unable to insert the plug fully into the outlet, try reversing the plug. If the plug should still fail to fit, contact your electrician to replace your obsolete outlet. Do not defeat the safety purpose of the polarized plug.
13. Power-Cord Protection – Power-supply cords should be routed so that they are not likely to be walked on or pinched by items placed upon or against them, paying particular attention to cords at plugs, convenience receptacles, and the point where they exit from the product.
15. Outdoor Antenna Grounding – If an outside antenna or cable system is connected to the product, be sure the antenna or cable system is grounded so as to provide some protection against voltage surges and built-up static charges. Article 810 of the National Electrical Code (ANSI/NFPA 70), provides information with regard to proper grounding of the mast and supporting structure, grounding of the lead-in wire to an antenna discharge unit, size of grounding conductors, location of antenna-discharge unit, connection to grounding electrodes, and requirements for the grounding electrode. See Figure A.
16. Lightning – For added protection for this product during a lightning storm, or when it is left unattended and unused for long periods of time, unplug it from the wall outlet and disconnect the antenna or cable system. This will prevent damage to the product due to lightning and power-line surges.
17. Power Lines – An outside antenna system should not be located in the vicinity of overhead power lines or other electric light or power circuits, or where it can fall into such power lines or circuits. When installing an outside antenna system, extreme care should be taken to keep from touching such power lines or circuits as contact with them might be fatal.
18. Overloading – Do not overload wall outlets, extension cords, or integral convenience receptacles as this can result in a risk of fire or electric shock.
19. Object and Liquid Entry – Never push objects of any kind into this product through openings as they may touch dangerous voltage points or short-out parts that could result in a fire or electric shock. Never spill liquid of any kind on the product.
20. Servicing – Do not attempt to service this product yourself as opening or removing covers may expose you to dangerous voltage or other hazards. Refer all servicing to qualified service personnel.
21. Damage Requiring Service – Unplug this product from the wall outlet and refer servicing to qualified service personnel under the following conditions:
  - a) When the power-supply cord or plug is damaged,
  - b) If liquid has been spilled, or objects have fallen into the product,
  - c) If the product has been exposed to rain or water,
  - d) If the product does not operate normally by following the operating instructions. Adjust only those controls that are covered by the operating instructions as an improper adjustment of other controls may result in damage and will often require extensive work by a qualified technician to restore the product to its normal operation,
  - e) If the product has been dropped or damaged in any way, and
  - f) When the product exhibits a distinct change in performance – this indicates a need for service.
22. Replacement Parts – When replacement parts are required, be sure the service technician has used replacement parts specified by the manufacturer or have the same characteristics as the original part. Unauthorized substitutions may result in fire, electric shock, or other hazards.
23. Safety Check – Upon completion of any service or repairs to this product, ask the service technician to perform safety checks to determine that the product is in proper operating condition.
24. Wall or Ceiling Mounting – The product should be mounted to a wall or ceiling only as recommended by the manufacturer.
25. Heat – The product should be situated away from heat sources such as radiators, heat registers, stoves, or other products (including amplifiers) that produce heat.

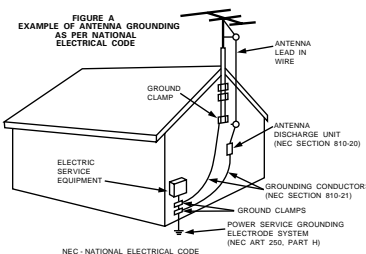

FRONT PANEL DIAGRAM

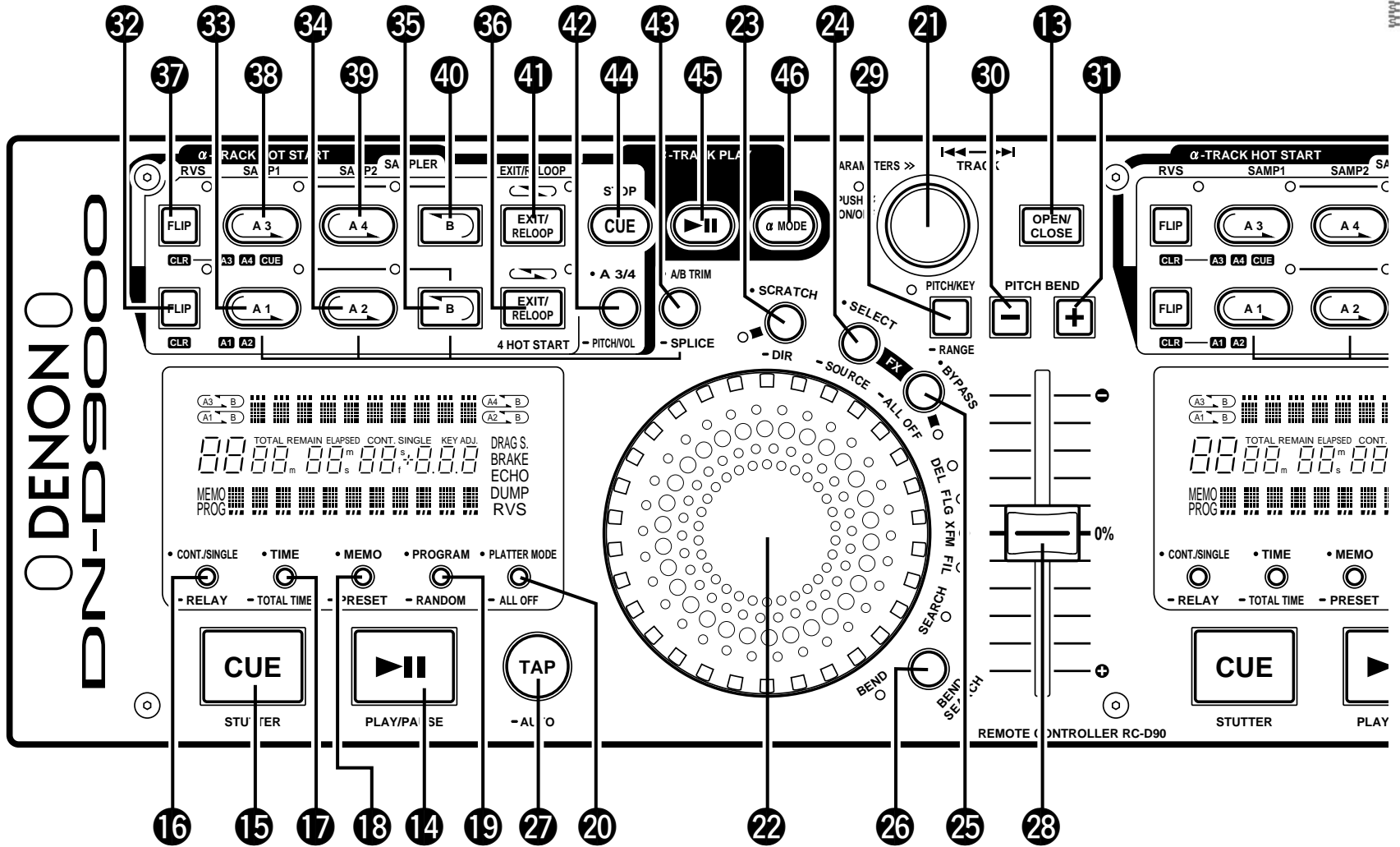

## FRONT PANEL DIAGRAM

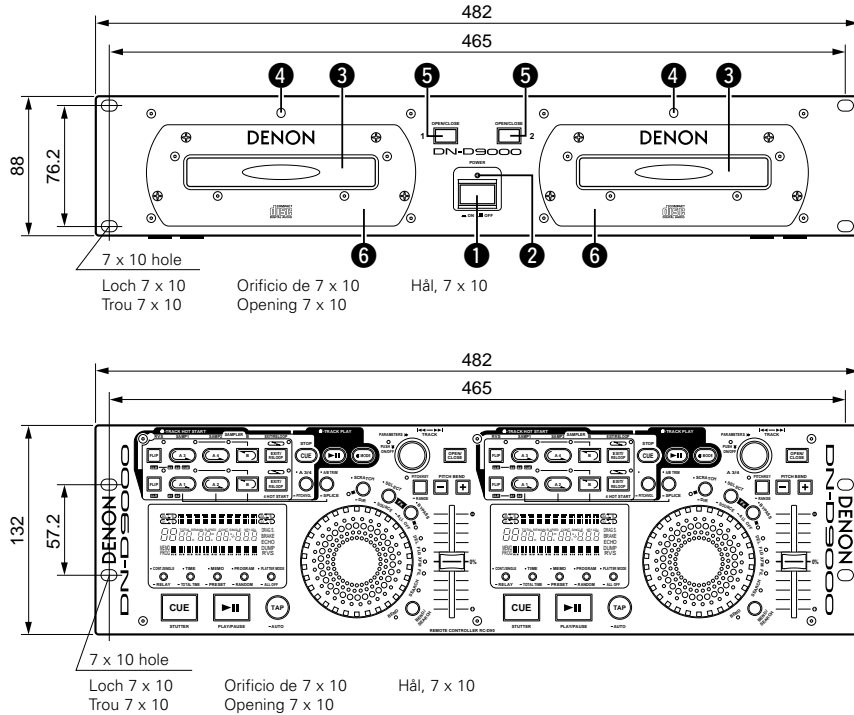

## REAR PANEL DIAGRAM

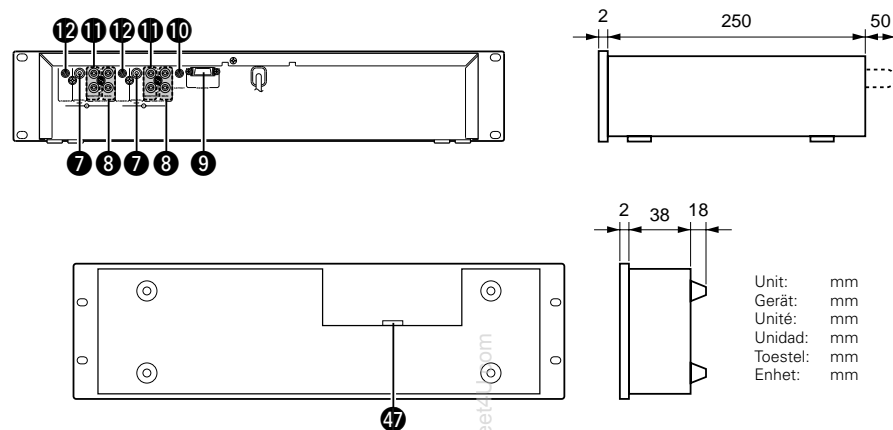

## NOTE ON USE / HINWEISE ZUM GEBRAUCH / OBSERVATIONS RELATIVES A L'UTILISATION / NOTAS SOBRE EL USO / ALVORENS TE GEBRUIKEN / OBSERVERA

<ul style="list-style-type: none"> <li>Avoid high temperatures. Allow for sufficient heat dispersion when installed on a rack.</li> <li>Vermeiden Sie hohe Temperaturen. Beachten Sie, daß eine ausreichende Luftzirkulation gewährleistet wird, wenn das Gerät auf ein Regal gestellt wird.</li> <li>Eviter des températures élevées. Tenir compte d'une dispersion de chaleur suffisante lors de l'installation sur une étagère.</li> <li>Evite altas temperaturas. Permite la suficiente dispersión del calor cuando está instalado en la consola.</li> <li>Vermijd hoge temperaturen. Zorg voor een degelijk hitteafvoer indien het apparaat op een rek wordt geplaatst.</li> <li>Undvik höga temperaturer. Se till att det finns möjlighet till god värmeavledning vid montering i ett rack.</li> </ul>	<ul style="list-style-type: none"> <li>Keep the set free from moisture, water, and dust.</li> <li>Halten Sie das Gerät von Feuchtigkeit, Wasser und Staub fern.</li> <li>Protéger l'appareil contre l'humidité, l'eau et l'apoussièrè.</li> <li>Mantenga el equipo libre de humedad, agua y polvo.</li> <li>Laat geen vochtigheid, water of stof in het apparaat binnendringen.</li> <li>Utsätt inte apparaten för fukt, vatten och damm.</li> </ul>	<ul style="list-style-type: none"> <li>Do not let foreign objects in the set.</li> <li>Keine fremden Gegenstände in das Gerät kommen lassen.</li> <li>Ne pas laisser des objets étrangers dans l'appareil.</li> <li>No deje objetos extraños dentro del equipo.</li> <li>Laat geen vreemde voorwerpen in dit apparaat vallen.</li> <li>Se till att främmande föremål inte tränger in i apparaten.</li> </ul>
<ul style="list-style-type: none"> <li>Unplug the power cord when not using the set for long periods of time.</li> <li>Wenn das Gerät eine längere Zeit nicht verwendet werden soll, trennen Sie das Netzkabel vom Netzstecker.</li> <li>Débrancher le cordon d'alimentation lorsque l'appareil n'est pas utilisé pendant de longues périodes.</li> <li>Desconecte el cordón de energía cuando no utilice el equipo por mucho tiempo.</li> <li>Neem altijd het netsnoer uit het stopcontact wanneer het apparaat gedurende een lange periode niet wordt gebruikt.</li> <li>Koppla ur nätkabeln om apparaten inte kommer att användas i lång tid.</li> </ul>	<ul style="list-style-type: none"> <li>Do not let insecticides, benzene, and thinner come in contact with the set.</li> <li>Lassen Sie das Gerät nicht mit Insektiziden, Benzin oder Verdünnungsmitteln in Berührung kommen.</li> <li>Ne pas mettre en contact des insecticides, du benzène et un diluant avec l'appareil.</li> <li>No permita el contacto de insecticidas, gasolina y diluyentes con el equipo.</li> <li>Laat geen insektenverdelgende middelen, benzine of verfvindner met dit apparaat in contact komen.</li> <li>Se till att inte insektsmedel på spraybruk, bensen och thinner kommer i kontakt med apparatens hölje.</li> </ul>	<ul style="list-style-type: none"> <li>Handle the power cord carefully. Hold the plug when unplugging the cord.</li> <li>Gehen Sie vorsichtig mit dem Netzkabel um. Halten Sie das Kabel am Stecker, wenn Sie den Stecker herausziehen.</li> <li>Manipuler le cordon d'alimentation avec précaution. Tenir la prise lors du débranchement du cordon.</li> <li>Maneje el cordón de energía con cuidado. Sostenga el enchufe cuando desconecte el cordón de energía.</li> <li>Hanteer het netsnoer voorzichtig. Houd het snoer bij de stekker vast wanneer deze moet worden aan- of losgekoppeld.</li> <li>Hantera nätkabeln varsamt. Håll i kabeln när den kopplas från el-uttaget.</li> </ul>
<ul style="list-style-type: none"> <li>Handle the power cord carefully. Hold the plug when unplugging the cord.</li> <li>Gehen Sie vorsichtig mit dem Netzkabel um. Halten Sie das Kabel am Stecker, wenn Sie den Stecker herausziehen.</li> <li>Manipuler le cordon d'alimentation avec précaution. Tenir la prise lors du débranchement du cordon.</li> <li>Maneje el cordón de energía con cuidado. Sostenga el enchufe cuando desconecte el cordón de energía.</li> <li>Hanteer het netsnoer voorzichtig. Houd het snoer bij de stekker vast wanneer deze moet worden aan- of losgekoppeld.</li> <li>Hantera nätkabeln varsamt. Håll i kabeln när den kopplas från el-uttaget.</li> </ul>	<ul style="list-style-type: none"> <li>Do not obstruct the ventilation holes.</li> <li>Die Belüftungsöffnungen dürfen nicht verdeckt werden.</li> <li>Ne pas obstruer les trous d'aération.</li> <li>No obstruya los orificios de ventilación.</li> <li>De ventilatieopeningen mogen niet worden geblokkeerd.</li> <li>Täpp inte till ventilationsöppningarna.</li> </ul> <p>* (For sets with ventilation holes)</p>	<ul style="list-style-type: none"> <li>Never disassemble or modify the set in any way.</li> <li>Versuchen Sie niemals das Gerät auseinander zu nehmen oder auf jegliche Art zu verändern.</li> <li>Ne jamais démonter ou modifier l'appareil d'une manière ou d'une autre.</li> <li>Nunca desarme o modifique el equipo de ninguna manera.</li> <li>Nooit dit apparaat demonteren of op andere wijze modificeren.</li> <li>Ta inte isär apparaten och försök inte bygga om den.</li> </ul>
<p><b>CAUTION</b></p> <ul style="list-style-type: none"> <li>The ventilation should not be impeded by covering the ventilation openings with items, such as newspapers, table-cloths, curtains, etc.</li> <li>No naked flame sources, such as lighted candles, should be placed on the apparatus.</li> <li>Please be care the environmental aspects of battery disposal.</li> <li>The apparatus shall not be exposed to dripping or splashing for use.</li> <li>No objects filled with liquids, such as vases, shall be placed on the apparatus.</li> </ul>		

#### • DECLARATION OF CONFORMITY

We declare under our sole responsibility that this product, to which this declaration relates, is in conformity with the following standards:

EN60065, EN55013, EN55020, EN61000-3-2 and EN61000-3-3.

Following the provisions of 73/23/EEC, 89/336/EEC and 93/68/EEC Directive.

#### • ÜBEREINSTIMMUNGSERKLÄRUNG

Wir erklären unter unserer Verantwortung, daß dieses Produkt, auf das sich diese Erklärung bezieht, den folgenden Standards entspricht:

EN60065, EN55013, EN55020, EN61000-3-2 und EN61000-3-3.

Entspricht den Verordnungen der Direktive 73/23/EEC, 89/336/EEC und 93/68/EEC.

#### • DECLARATION DE CONFORMITE

Nous déclarons sous notre seule responsabilité que l'appareil, auquel se réfère cette déclaration, est conforme aux standards suivants:

EN60065, EN55013, EN55020, EN61000-3-2 et EN61000-3-3.

D'après les dispositions de la Directive 73/23/EEC, 89/336/EEC et 93/68/EEC.

#### • DECLARACIÓN DE CONFORMIDAD

Declaramos bajo nuestra exclusiva responsabilidad que este producto al que hace referencia esta declaración, está conforme con los siguientes estándares:

EN60065, EN55013, EN55020, EN61000-3-2 y EN61000-3-3.

Siguiendo las provisiones de las Directivas 73/23/EEC, 89/336/EEC y 93/68/EEC.

#### • EENVORMIGHEIDSVKLAARING

Wij verklaren uitsluitend op onze verantwoordelijkheid dat dit product, waarop deze verklaring betrekking heeft, in overeenstemming is met de volgende normen:

EN60065, EN55013, EN55020, EN61000-3-2 en EN61000-3-3.

Volgens de bepalingen van de Richtlijnen 73/23/EEC, 89/336/EEC en 93/68/EEC.

#### • ÖVERENSSTÄMMELSEINTYG

Härmed intygas helt på eget ansvar att denna produkt, vilken detta intyg avser, uppfyller följande standarder:

EN60065, EN55013, EN55020, EN61000-3-2 och EN61000-3-3.

Enligt stadgarna i direktiv 73/23/EEC, 89/336/EEC och 93/68/EEC.



- Use compact discs that include the  mark.

CD's with special shapes (heart-shaped CD's, octagonal CD's etc.) cannot be played on this set. Attempting to do so may damage the set. Do not use such CD's.

- Benutzen Sie Compact Discs, die das  Zeichen tragen.

Speziell geformte CD's (herzförmige CDs, achteckige CDs, usw.) können auf dieser Anlage nicht abgespielt werden.

Der Versuch derartige CDs abzuspielen kann die Anlage beschädigen. Verzichten Sie auf die Benutzung solcher CDs.

- Utiliser des disques compacts portant le logo .

Des CD avec des formes spéciales (CD en forme de coeur, des CD octogonaux, etc.) ne peuvent pas être lus sur cet appareil.

Le fait de l'essayer, risque d'endommager le lecteur. Ne pas utiliser de tels CD.

- Use discos compactos con la marca .

En este equipo no es posible reproducir CDs con formas especiales (CDs con forma de corazón, CDs octogonales, etc.).

Si intenta hacerlo, el equipo podrá resultar dañado. No use este tipo de CDs.

- Gebruik compact discs voorzien van het logo .

CD's met speciale vormen (bijv. CD's in de vorm van een hart, achthoekige CD's, enz.) kunnen met dit toestel niet worden afgespeeld.

Wanneer u dit toch probeert, zal u het toestel beschadigen. Speel dergelijke CD's dus niet af.

- Använd CD-skivor med -märket.

Specialformade CD-skivor (hjärtformade, åttkantiga, m m) går inte att spela på den här apparaten. Utströningen kan skadas om du försöker göra detta. Använd inte CD-skivor av denna typ.

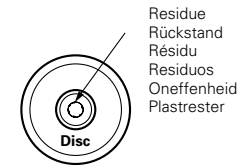

Residue  
Rückstand  
Résidu  
Resíduos  
Oneffenheid  
Plastrester

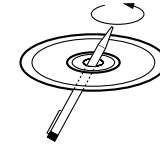

- The disc may not play normally if there is residue along the edges of the center hole.
- When using new discs in particular, use a pen, etc., to remove the residue.
- Die Disk kann nicht normal abgespielt werden, wenn sich ein Rückstand entlang der Mittellochenden befindet.
- Insbesondere, wenn Sie neue Disks benutzen, dann entfernen Sie mit einem Stift, etc. den Rückstand.
- Le disque peut ne pas être lu normalement s'il y a un résidu le long des bord du trou central.
- Lors de l'utilisation de nouveaux disques en particulier, utiliser un stylo à bille, etc., pour enlever le résidu.
- El disco no puede ser reproducido normalmente debido a la terminación deficiente de los bordes del agujero central.
- Para quitar estos residuos de material, especialmente cuando vaya a re-producir discos nuevos, utilice un bolígrafo, o algo similar.
- Het is mogelijk dat de disc niet normaal wordt weergegeven als de randen van het middengat van de schijf oneffenheden vertonen.
- Verwijder vooral bij gebruik van nieuwe discs de oneffenheden met een pen of iets dergelijks.
- Det kan uppstå fel vid CD-avspelingen om det finns plastrester kvar i mitthålet.
- Tänk på att bort dessa med en penna, e d, särskilt om CD-skivan är ny.

#### • FOR CANADA MODEL ONLY

### CAUTION

TO PREVENT ELECTRIC SHOCK, MATCH WIDE BLADE OF PLUG TO WIDE SLOT, FULLY INSERT.

#### • POUR LES MODELE CANADIENS UNIQUEMENT

### ATTENTION

POUR ÉVITER LES CHOCS ÉLECTRIQUES, INTEROUIRE LA LAME LA PLUS LARGE DE LA FICHE DANS LA BORNE CORRESPONDANTE DE LA PRISE ET POUSSER JUSQU' AU FOND.

#### CAUTION:

DO NOT USE THE DENON AMC-22 CD PICK-UP LENS CLEANER FOR THIS PRODUCT. THIS MIGHT DAMAGE THE LASER PICK-UP OF THIS PRODUCT.

#### ACHTUNG:

VERWENDEN SIE NICHT DEN CD-ABTAST-LINSENREINIGER DENON AMC-22 FÜR DIESES PRODUKT. SOLLTEN SIE DIES NICHT BEACHTEN, KÖNNTE DER LASERABTASTKOPF DIESES PRODUKTES BESCHÄDIGT WERDEN.

#### ATTENTION :

N'UTILISEZ PAS LE NETTOYEUR DE CAPTEUR D'OBJECTIF CD DENON AMC-22 POUR CE PRODUIT. CECI POURRAIT ENDOMMAGER LE CAPTEUR LASER DE CD DE CE PRODUIT.

#### PRECAUCIÓN:

NO UTILICE EL LIMPIADOR DE OBJETIVO DEL DETECTOR DE CD DEL DENON AMC-22 PARA ESTE PRODUCTO. ESTO PUEDE DAÑAR EL DETECTOR LASER DE ESTE PRODUCTO.

#### OPGELET:

GEBRUIK DE PICK-UPLINSENREINIGER VAN DE DENON AMC-22 NIET VOOR DIT PRODUCT. DIT KAN DE LASER PICK-UP VAN DIT PRODUCT BESCHADIGEN.

#### FÖRSIKTIGT:

ANVÄND INTE LINSAVPUTSAREN FÖR DENON AMC-22:NS CD-PICKUP FÖR DENNA PRODUKT. DET KAN SKADA PRODUKTENS LASERPICKUP.

– TABLE OF CONTENTS –

1	Main features .....	6	10	A-B trim .....	16
2	Connections/Installation .....	7	11	A3/4 for Sampler, 4 hot start, Alpha-track hot start .....	17, 18
3	Part names and functions .....	7 ~ 10	12	Platter effect .....	19
4	Compact discs .....	10	13	Effector (FX) .....	20
5	Basic operation .....	11	14	Memo .....	21
6	Scratch .....	11	15	Preset .....	22
7	Playing the alpha track (Real time sampler) .....	12	16	Program/Random/Relay play/ Power on play .....	23, 24
8	Alpha mode (Alpha track monitor) .....	13	17	Specifications .....	25
9	Seamless loop/Hot start/ Stutter and Splice .....	14, 15			

• ACCESSORIES

Check that the following parts are included in addition to the main unit:

① Operating instructions .....	1	③ Remote control unit (RC-D90) .....	1
② Connection cords for signal output (RCA) .....	2	④ Remote control connection cable .....	1

1 MAIN FEATURES

Congratulations on your new purchase of the DN-D9000. The DN-D9000 double CD player is equipped with a variety of advanced features, functions and rich performance for unlimited creativeness and showmanship.

Professional Structure and parts

1. **Removable drives (New)**  
Our newly designed replaceable drive structure is geared for professionals who require virtually "zero down time". The heavy-duty drives are built with optimum parts to assure longevity.
2. **19-inch rack mountable**  
The DN-D9000 can be easily mounted in a standard 19-inch DJ rack.
3. **Visible Displays (Improved)**  
Visibility is greatly improved thanks to the large FL tube displays, backlit buttons and disc holder illumination, which comes in handy during low light environments.
4. **Improved Controller Interface**  
Good feeling and operation thanks to a large Jog Wheel, Track Select/Parameters knob and soft rubber buttons.

Features and Functions

The implementation of powerful DSP's and large memory capacity allows for many new controlling features such as:

1. **SCRATCH (Improved)**  
The scratch sound is manipulated according to the direction and speed in which the jog dial is turned. This allows you scratch CDs virtually in the same way as with vinyl records on an analog turntable.

2. **SEAMLESS LOOP (Improved)**  
With this function, any section of a track can be played repeatedly with no break in sound or limit in length. The DN-D9000 supports a total of eight Seamless Loops for both drives. The DN-D9000 also has a variety of looping functions.
3. **SHOCKPROOF MEMORY (Improved)**  
16 seconds of shock-proof memory (per drive) guards against audible interruptions due to external mechanical shocks such as bumps or other hard vibrations, which is especially helpful for the mobile DJ as well as for nightclub-installed applications.
4. **ALPHA-TRACK PLAY (New)**  
This powerful new function allows independent and simultaneous playback of another track from the same disc, we call this the "Alpha-Track". The playing pitch and output level for the Alpha-Track can be adjusted.
5. **ALPHA-MODE (New)**  
The Alpha-Track output can be heard through the MONITOR OUT RCA jacks separately, so you can play up to four tracks simultaneous through a 4-channel mixer. This lets you switch smoothly from a "Live" playing track to the next track on the same CD with no break in sound.
6. **HOT START and STUTTER (Improved)**  
The Hot Start function lets you start playback immediately from a set point decided by you. Up to four points can be set per drive in the 4 Hot Start mode setting.  
The loaded Hot Starts can also be used to

"Stutter" those same points. When in Stutter mode, momentary audio is heard according to the length of time of which these buttons are held down and released.

7. **SPLICE (New)**  
This function removes unwanted sections of a track seamlessly such as; long vocal breaks found in dance mixes or explicit lyrics found in Pop music.
8. **SAMPLER (Improved)**  
Each of four on-board digital samplers can record up to 15 seconds CD quality sound at 44.1kHz sampling frequency. You can seamlessly loop these samples or play them backwards (reverse). The pitch and output level of each sample can be adjusted independently.  
The B point can be easily set or changed exactly the same way as you would with the A-B seamless loop function.
9. **A-B TRIM and MOVE (New)**  
The A and B points for the seamless loop, sampler loop and splice points can easily be adjusted using the Jog Wheel.  
Two modes are available for A/B adjust.  
**A-B TRIM:** For adjusting the points while playing the live loop.  
**A/B MOVE:** For moving the points using the manual search.
10. **PLATTER MODE (Improved)**  
Analog turntable-like playback can be simulated using five Platter effects.  
**DRAG START:** Simulates the dragging sound of a belt drive turntable starting up from a stop mode.  
**BRAKE:** Simulates a winding-down sound of a vinyl turntable coming to a full stop slowly.  
**TAIL ECHO:** Adds an echo sound when playback is paused.  
**DUMP:** Plays the sound backwards while continuing in a forward motion without losing "elapse time" when you return back to normal play.  
**RVS:** (Reverse) Plays the sound backwards until you return to normal play.
11. **EFFECTOR (Improved)**  
Using the four on-board effectors you can get various types of sound.  
**DELAY:** Adds a delay to your original track with adjustable parameters.  
**FLANGER:** Adds a Flange sound to your original track with adjustable parameters.  
**XFM (TRANSFORM):** Mutes the sound of your original track in precisely time intervals that is adjustable.  
**FILTER:** Changes the frequency range of a track for added effect with adjustable parameters.

12. **AUTO BPM COUNTER and manual TAP (New)**
13. **MEMO (Improved)**

Various settings such as Hot Starts, A-B Loops, A-B Splice, Pitch and Key Adjust can be saved internally to non-volatile memory for later recall. Up to 5000 points are available (1 memory per track).

The memory function can also be used in the Alpha Mode and memory contents can be exchanged.

14. **PITCH/KEY ADJUST (Improved)**

**PITCH:** Playback speed is adjusted with PITCH slider. Adjustable pitch ranges are +/- 4, 10, 16, 24, 100% (selectable).

**KEY ADJUST:** Keeps the original key even if the pitch playing speed is changed with the PITCH slider.

15. **DIGITAL OUT (Improved)**

The digital output for each drive provides a true 100% digital signal without any restrictions or limitations regardless of pitch change or mode setting.

16. **FADER START/ X-EFFECT**

The DN-D9000 FADER START and X-EFFECT controls are compatible with our DN-X800 mixer. Only Fader Start is compatible with the DN-X400 mixer.

17. **PROGRAM/RANDOM/RELAY PLAY**

You can playback tracks in various modes with PROGRAM Play, RANDOM Play and RELAY Play modes.

18. **PRESETS**

It is possible to customize the machine to your preference by saving your favorite setting to internal memory. For items found in the presets, please see page 22.

## 2 CONNECTIONS/INSTALLATION

1. Turn off the POWER switch.
2. Connect the RCA pin cords between the DN-D9000 outputs and inputs of your mixer. Be sure MAIN OUTs are main outputs and MONITOR OUTs are outputs of Alpha-Track sound.
3. Connect included control cord to the REMOTE connector on remote controller (RC-D90) tightly.
4. If your mixer has Fader Start function such as our DENON DN-X800 or DN-X400, connect FADER 1, 2 jacks to the mixer using 3.5 mm stereo mini cord.
5. If you have a DENON DN-X800 mixer, you can use the X-Effect function to control the Hot Starts, Samplers and Brake from the crossfader to get wide variety of operation. You may also trigger the Alpha Track by connecting Fader Start 1, 2 to the DN-X800 mixer using the 3.5 mm stereo mini cords.

The DN-D9000 is designed to be used horizontal. If main unit is tilted, the DN-D9000 may not function properly or disc may not be loaded or unloaded properly.

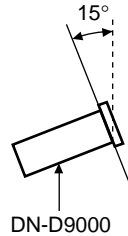

Fig. 1: Fader start connections

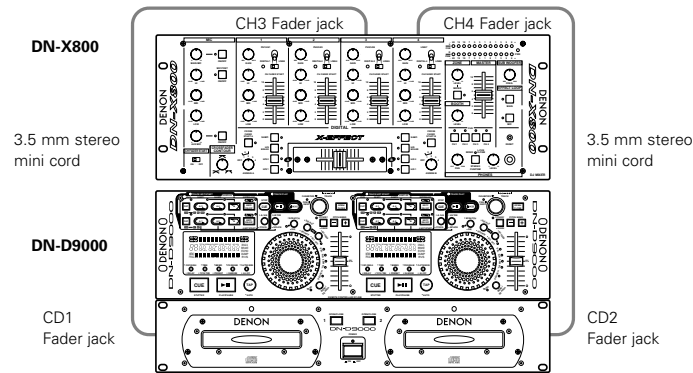
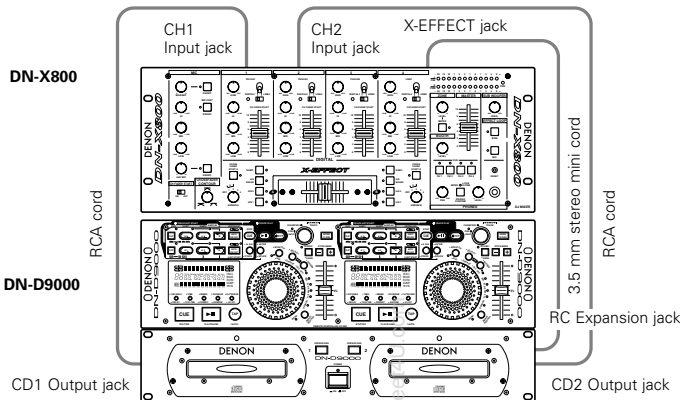

Fig. 2: X-Effect connections



## 3 PART NAMES AND FUNCTIONS

### (1) DN-D9000 Front panel

#### 1 POWER button (ON/OFF)

- Push this button to turn power on and off.

#### NOTE:

- Be sure to close the disc holders before turning off the power. Otherwise disc holder may be damaged.

#### 2 POWER indicator

- This indicator lights up red when the power on.

#### 3 Disc holder

- Push OPEN/CLOSE button to open Disc holder.
- Place disc in the tray holder correctly.
- Push OPEN/CLOSE button then Disc holder closes.

#### CAUTION:

- Do not place foreign objects in Disc holder, otherwise damage may occur.
- Do not push Disc holder by hand when the power off, this may result in malfunction and damage the drive.

#### 4 Disc holder LED

- Blue LED flashed while Disc holder is opening and closing.
- This LED lights up and illuminates the Disc Holder.

#### 5 OPEN/CLOSE button

- To open and close the Disc holder, push this button.
- This button will not work during playback or other inhibited mode.

#### 6 CD Drive

- These Drives are field replaceable by you.
- Optional spare drives are sold separately through any DENON authorized dealer. Product name: BU-9000.

### (2) DN-D9000 Rear panel

#### 7 Digital output jacks 1, 2 (DIGITAL OUT 1, 2)

- Digital data is output from these jacks.
- Use 75 Ω/ohms pin cord for connections.

#### NOTE:

- For digital output signal, the output level is set to -6 dB from the original level in order to avoid clipping problem when the Sampler and/or Effector sounds are added.

#### 8 Main Analog output jacks 1, 2 (LINE OUT MAIN 1, 2)

- These are unbalanced RCA output jacks.
- Analog signal outputs.
- Connect to the mixer inputs.

#### 9 Remote connector (REMOTE)

- Connect this connector to the RC-D90 using the included cord.

#### 10 X-Effect jack (X-EFFECT)

- Connect this cable to the DENON mixer DN-X800 with 3.5 mm stereo mini cord.

#### 11 Monitor Analog output jacks 1, 2 (LINE OUT MONITOR 1, 2)

- These are unbalanced RCA output jacks.
- Alpha-Track audio signals are output.

#### 12 Fader Start jacks (FADER 1, 2)

- Use these when your mixer has Fader Start function with 3.5 mm stereo mini cord.

**(3) RC-D90 Front panel****CAUTION:**

- Note that there are many buttons working two different functions selected by short time pushing or long pushing (1 second or more). The
  - mark indicates short time push function and
  - mark indicates long time push function.

**13 OPEN/CLOSE button**

- Open or close disc holder with these buttons while button illuminations light. Note that if illumination is off, you cannot open disc holder. (Eject lock function)

**14 PLAY/PAUSE button (▶||)**

- This button will start or pause playback.
- Push once to start playback, once again to pause playback, and once more to resume playback.

**15 CUE/STUTTER button**

- CUE:**  
Pushing this button in Play mode will force the track back to the position which playback started. While in search mode, it makes new Cue point.
- STUTTER:**  
In Cue mode, by pushing the CUE button makes a Stutter sound from the Cue point. This is called STUTTER PLAY.

**16 • CONT/SINGLE, – RELAY button**

- CONT./SINGLE:**  
Short pushing play ending mode between CONT (continue: play more tracks) and SINGLE (stop playing at current track played).
- RELAY:**  
You can turn on and off RELAY PLAY mode. In RELAY PLAY mode, playback continues to the other drive if all tracks are played.

**17 • TIME, – TOTAL TIME button**

- TIME:**  
A quick push will display mode changes between ELAPSED TIME and REMAIN TIME.
- TOTAL:**  
A long push, will display mode changes between TRACK TIME and DISC TIME.
- So, you can select display mode from four modes, TRACK ELAPSED, TRACK REMAIN, DISC ELAPSED and DISC REMAIN.

**18 • MEMO, – PRESET button**

- MEMO:**  
The memo mode starts when this button is pushed once in the Cue mode.

- PRESET:**  
When this button is pushed for more than 1 sec, the PRESET mode starts.

**19 • PROGRAM, – RANDOM button**

- PROGRAM:**  
With a short push in Cue mode, you can make list of program play and turn on/off Program play mode using PARAMETERS knob.
- RANDOM:**  
With a long push in Cue mode, Random play mode can be turned on/off with PARAMETERS knob.

**20 • PLATTER MODE, – ALL OFF button**

- PLATTER MODE:**  
When pushing this button, you can select a Platter Effect type from DRAG S, BRAKE, ECHO, DUMP and RVS, and can turn each one on/off individually.
- ALL OFF:**  
When this button is pushed for more than 1 sec, all the Platter Effect settings are cancelled.

**21 TRACK/PARAMETERS knob**

- TRACK:**  
When PARAMETERS LED is off, turn this knob to select tracks.  
By pushing this knob down while turning, the tracks will change 10 at a time.
- PARAMETERS:**  
When the PARAMETER LED is flashing, turn this knob to select and change the parameter for items found in the Effector, Program, Memo, and Preset data, etc.
- Push this knob down during Effect mode to change the status to on/off.

**22 Jog Wheel**

- Use this for the Manual Search, Scan, Pitch Bend and Scratch operations, or to also select the effect parameter, etc.

**23 • SCRATCH, – DIR button**

- SCRATCH:**  
Push this button quickly to turn Scratch mode on and off. When Scratch mode is on, SCRATCH LED is flashing.
- DIR:**  
Push this button for more than 1 sec to select playback direction of scratch.

**24 • FX SELECT, – FX SOURCE button**

- SELECT:**  
Push this button a short time to select the effect function from DELAY, FLANGER, XFM., FILTER. Sound of selected effector can be adjusted with PARAMETERS knob and Jog Wheel.
- SOURCE:**  
If pushed for more than 1 sec, you can select source for Effector functions.

**25 • FX BYPASS, – FX ALL OFF button**

- BYPASS:**  
Push this button to bypass Effector temporarily and BYPASS LED starts flashing. The Effects are returned by pushing the BYPASS button once again.
- ALL OFF:**  
When pushed for more than 1 sec, all the Effects are turned off.

**26 BEND/SCRATCH button**

- Push this to switch the Jog Wheel mode between Pitch Bend and Manual Search.  
**BEND mode:**  
Either Pitch Bend or Platter Hold function can be conducted with the Jog Wheel. Pitch Bend function works when Jog Wheel is turned slowly, Platter Hold works with Jog Wheel is turned quickly. In this mode, BEND LED is flashing.  
**Manual Search:**  
Manual Search and Scan can be conducted with Jog Wheel. While turn Jog Wheel slowly, Manual Search works and you can move point by one frame (1/75 second) with sound. If turned fast, SCAN will work and point moves long distance with sound. In this mode, SEARCH LED is flashing.
- When playback is started from Manual Search, Pitch Bend mode is set instead of Manual Search mode automatically.
- When Cue is set while in the Pitch Bend mode, Manual Search mode is set automatically.

**27 • TAP, – AUTO button**

- TAP:**  
When you push this button repeatedly, the Auto mode turns off and starts measuring your Beats Per Minute (BPM) by tapping.  
**NOTE:** If you select a new track, AUTO BPM mode turns on automatically.
- AUTO:**  
When pushing the TAP button for 1 second, activates AUTO BPM mode.

- The measured BPM is displayed in the character section of the display.

**28 Pitch Slider**

- Use this slider to adjust playing speed.
- The playing speed decreases when slide upwards and increases downwards.

**29 • PITCH/KEY, – RANGE button**

- With this button you can select PITCH and KEY ADJUST mode. Mode changes Pitch on, Key Adjust on and both off cyclically. PITCH LED indicates in Pitch mode and KEY ADJUST indicator lights up in Key Adjust mode.
- RANGE:**  
Push this button for more than 1 sec to select the pitch range.

**30 PITCH BEND – button****31 PITCH BEND + button**

- Pushing these buttons will change playing speed temporary.
- While pushing PITCH BEND + button playing speed increases and speed decreases while pushing PITCH BEND – button.
- When release button, playing speed returns to the previous speed.

**32 FLIP/CLR button**

- Use this to select operating mode of A1 and A2 buttons, from Hot Start mode and Stutter mode. FLIP LED lights up in Hot Start mode.
- If the FLIP button is pushed while pushing the A1 or A2 button, you can clear the selected A point.  
By holding down just the FLIP button for more than 1 sec, you can clear A1 and A2 points all at once.

**33 A1 button****34 A2 button**

- Using these buttons you can create starting points for Hot Start, Seamless Loop, Stutter and Splice playback.
- The button illumination changes its color to inform different modes.  
Orange ...Hot Start mode  
Green ...Alpha-Track Hot Start mode  
Yellow ...Splice mode

**35 B button**

- Use this to set the B point for A1 and A2 seamless loop and splice playback end.
- The B LED indicates conditions about B point.  
B LED lit:  
Already B point was set.  
B LED flashing:  
In Splice point setting mode



**36 EXIT/RELOOP button**

- Use this to exit, back again to Seamless Loop playback for A1 and A2 with keeping all loop settings. You can add variety looping with this function.
- The LED indicates what's going on about looping.  
EXIT/RELOOP LED lit:  
Seamless Loop on or playing.  
EXIT/RELOOP LED flashing:  
Playback after exit loop.
- This button also switches repeat play modes on and off in Program, Random mode.

**37 (SAMP) RVS/FLIP/CLR button**

- **(SAMP)RVS:**  
Use this to select the sample play direction forward and reverse. When select reverse RVS LED lights up.
- **FLIP:**  
If in 4 Hot Start mode or Alpha-Track Hot Start mode, this button works as FLIP button for A3, A4. You can select Hot Start or Stutter mode. When Hot start mode is selected FLIP LED lights up.
- If the FLIP button is pushed while pushing the A3, A4 or Alpha-Cue button, the selected A point or the Alpha-Cue point is cleared. By holding down just the FLIP button for more than 1 sec, you can clear A3 and A4 points all at once.

**38 SAMP1/A3 button****39 SAMP2/A4 button**

- **SAMP1/SAMP2:**  
In the sampler mode, push these buttons to record or play sound of Sampler 1 or 2.
- **A3, A4:**  
When in the 4 Hot Start or Alpha-Track Hot Start modes, these act as A3 or A4 button. You can use these buttons for Hot Start, Seamless Loop and Stutter playback.
- These 4 buttons illumination color changes in the different modes.  
Orange .4 Hot Start mode  
Green ....Alpha-Track Hot Start or Sampler mode

**40 (SAMP) B, B button**

- **(SAMP)B:**  
In the Sampler mode, use this to set the sampler loop B point.
- **B:**  
In the 4 Hot Start or Alpha-Track Hot Start modes, use this to set the B point for A3 or A4 button seamless looping.

**41 (SAMP) EXIT/RELOOP, EXIT/RELOOP button**

- **(SAMP)EXIT/RELOOP:**  
Use this to turn the Sampler Loop mode on and off. Also acts as EXIT/RELOOP button for Sampler Loop to exit or back again.
- **EXIT/RELOOP:**  
In the 4 Hot Start or Alpha-Track Hot Start modes, use this to exit or back again Seamless Loop for A3 and A4.
- EXIT/RELOOP LED indicates conditions of loop.  
EXIT/RELOOP LED lit:  
Seamless Loop on or playing.  
EXIT/RELOOP LED flashing:  
Playback after exit loop.

**42 ● A3/4, = PITCH/VOL button**

- **A3/4:**  
After a short push, A3, A4 button operating mode can be selected with the PARAMETERS knob from Sampler, 4 Hot Start, Alpha-Track Hot Start.
- **PITCH/VOL:**  
After pushing for more than 1 sec, pitch and output level of Sampler, Alpha-Track playback can be adjusted with the PARAMETERS knob.

**43 ● A/B TRIM, = SPLICE button**

- **A/B TRIM:**  
With a short push of this button, the A and B point trim mode changes on and off while in PLAY or CUE mode.
- **SPLICE:**  
When pushed for more than 1 sec , Splice point setting mode for A1 and A2 starts.

**44 α (Alpha) CUE/SAMP STOP/STUTTER button**

- **α (Alpha) CUE/STUTTER:**  
Use this as CUE and STUTTER button in Alpha-Track.
- **SAMP STOP:**  
Push while Sampler playback, Sampler playback stops.
- This button lights up when the Alpha-CUE point is set.

**45 α (Alpha) TRACK PLAY/PAUSE button**

- When this button is pushed while in the Cue or Pause mode, the Alpha-Track playback starts. By pushing it once again will Pause the Alpha-Track.
- It is necessary to make Cue point for the Alpha-Track before starting Alpha-Track playback.

**(4) RC-D90 Rear panel****47 REMOTE connector**

- Connect this connector to the REMOTE connector on the DN-D9000 using the included cord.

(5) Display

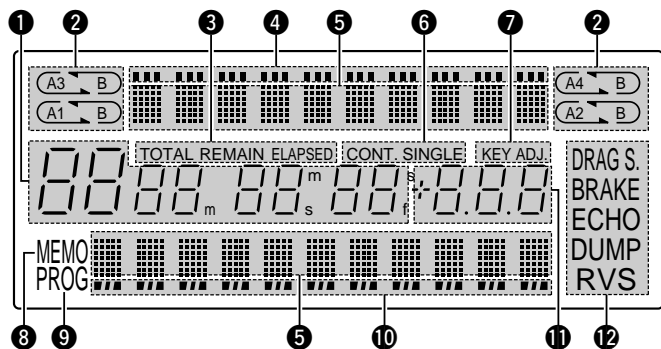

**1 Track, minute, second and frame displays**

- These displays indicate current position information.

**2 Loop mode indicators**

- DN-D9000 has Loop mode indicators consist of four sets of A (A1, A2, A3, A4), B and two arrows. A and B marks indicate A and B points are exist.
- Two arrows indicate loop setting mode as follow.

**Example: A1 B**

or Left arrow only on:

Hot Start mode

Both arrows on:

Seamless Loop mode

Both arrows flashing:

Seamless Loop Playing

Left arrow on, right flashing:

Exit play from Seamless Loop

**3 Time mode indicators**

- When the TIME/TOTAL TIME button is pushed, the Time mode indicator switches as follows:  
ELAPSED:  
Track's elapsed time is displayed.  
REMAIN:  
Track's remaining time is displayed.  
TOTAL + ELAPSED:  
The total elapsed time of disc or programmed track is displayed.  
TOTAL + REMAIN:  
The total remaining time of disc or programmed track is displayed.

**4 Parameter indicators (upper 30 dots)**

- Upper 30 dots on display indicate parameter, data setting for Effector visually.

**5 Character display**

- You can select mode or function using PARAMETERS knob following the short message which is displayed on the character display part.
- The character display indicates the operation, mode name, data, etc., and displays such guide messages as "Yes/Push\_PM" means if "YES", push ParaMeters knob. The display indicates  $\gg$  and  $\sphericalangle$  marks sometime, note that  $\gg$  mark says you to turn PARAMATERS knob and  $\sphericalangle$  marks says to push PARAMATERS knob.
- The PARAMETERS LED flashes when you can use PARAMETER knob, otherwise this knob used for Track Selection.

**6 Play mode indicators**

- When SINGLE indicator lights up, playback will finish at end of current track.
- When CONT. indicator lights up, playback continues.

**7 KEY ADJ. indicator**

- KEY ADJ. sign appears in display when in the Key Adjust mode.

**8 MEMO indicator**

- MEMO sign appears in display when there is a memory setting for the currently playing track or the track at which the standby mode is currently set.

**9 PROG indicator**

- This indicator lights up when program data has been set and when program data is stored in the memory.

**10 Play Position indicators (Play position indicator lower 33)**

- **Play position indicator:**  
The 33 white dots indicate where is playing visually in a track in the normal play. The 11 Orange dots indicate play position in the reverse play mode.
- **End of Message:**  
When the time remaining to the end of the track is less than the specified time, the EOM (End Of Message) play position indicator flashes along with the remaining time, notifying of the track end.  
\* The EOM time can be set with the presets.

**11 Pitch display**

- This numeric indicator display the playback speed (pitch).

**12 PLATTER MODE indicators**

- There are signs of Platter Effects DRAG S., BRAKE, ECHO, DUMP, RVS. These signs light up when mode is on.

**4 COMPACT DISCS**

**1. Precautions on handling compact discs**

- Do not allow fingerprints, oil or dust to get on the surface of the disc.  
If the disc is dirty, wipe it off with a soft dry cloth.
- Do not use benzene, thinner, water, record spray, electrostatic-proof chemicals, or silicone-treated cloths to clean discs.
- Always handle discs carefully to prevent damaging the surface; in particular when removing a disc from its case or returning it.
- Do not bend the disc.
- Do not apply heat.
- Do not enlarge the hole in the center of the disc.
- Do not write on the label (printed side) with a hard-tipped implement such as a pencil or ball point pen.
- Condensation will form if a disc is brought into a warm area from a colder one, such as outdoors in winter. Do not attempt to dry the disc with a hair dryer, etc.

**2. Precautions on storage**

- After playing a disc, always unload it from the player.
- Always store the disc in the jewel case to protect from dirt or damage.
- Do not place discs in the following areas:  
(1) Areas exposed to direct sunlight for a considerable time.  
(2) Areas subject to accumulation of dust or high humidity.  
(3) Areas affected by heat from indoor heaters, etc.

## 5 BASIC OPERATION

### Play and Pause





- Each push of the **14** PLAY/PAUSE button switches between playback and pause. PLAY/PAUSE button illuminates solid green during playback and flashed in pause.
- When the **14** PLAY/PAUSE button is pushed during play, the DN-D9000 pauses playback at that point. Push **14** PLAY/PAUSE button once again and playback resumes.

### Play and Cue

- When the **15** CUE button is pushed during playback, the track stops and returns to the position that current playback started (Cue point) and prepares for next playback. This function is called Back-Cue. With Back-Cue function, you can start from exactly same position. The CUE button illuminates solid red when DN-D9000 is ready to start playback.
- You can set and change Cue point as follows.
  - When you started playback.
  - Track select finished.
  - Manual Search.



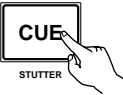

### Move the Cue Point

- If you would not like to start playback from beginning of the track, you need to move Cue Point using Manual Search function.

<b>1</b>	Push the <b>26</b> BEND/SEARCH button to set Jog Wheel to search mode. The SEARCH LED will flash.	
<b>2</b>	Turn the <b>22</b> Jog Wheel to change Cue point. You can hear the short sound of the current Cue point.	
<b>3</b>	After you found your preferred Cue point, push the <b>15</b> CUE button then new Cue point is set.	
<b>4</b>	The Manual Search speed changes according to the speed at which the <b>22</b> Jog Wheel is turned.	



### Adjusting the Pitch

- With Pitch slider you can adjust the playback speed (Pitch).
- If you would not change key of sound, use the Key Adjust function.

<b>1</b>	Push the <b>29</b> PITCH/KEY button to PITCH LED lights up.	
<b>2</b>	<p>Pitch decreases</p>  <p>Move the <b>28</b> Pitch slider to adjust the pitch. The current pitch setting is displayed on the display.</p> <p>Pitch increases</p> 	
<b>3</b>	DN-D9000 has five pitch ranges, 4%, 10%, 16%, 24% and 100%. When the <b>29</b> RANGE button is pushed for more than 1 sec, the pitch range can be selected with the PARAMETERS knob.	

### Pitch Bend





- With PITCH BEND function you can change pitch temporary. DN-D9000 has two ways for this function PITCH BEND buttons and Jog Wheel.

<b>1</b>	<p><b>[PITCH BEND +/- buttons]</b></p> <ul style="list-style-type: none"> <li>• Push the <b>30</b> PITCH BEND - or <b>31</b> + button for momentary change of pitch.</li> <li>• While holding these buttons down, the pitch continues to change up to the limitation.</li> <li>• After releasing the PITCH BEND buttons, playback pitch returns to slider setting.</li> </ul>	
<b>2</b>	<p><b>[Jog Wheel]</b></p> <ul style="list-style-type: none"> <li>• In Play mode, the BEND LED starts flashing.</li> <li>• The pitch increases gradually when the <b>22</b> Jog Wheel is turned clockwise and decreases when turned counterclockwise.</li> <li>• When you stop turning the Jog Wheel, the playing speed returns to the previous pitch.</li> </ul>	

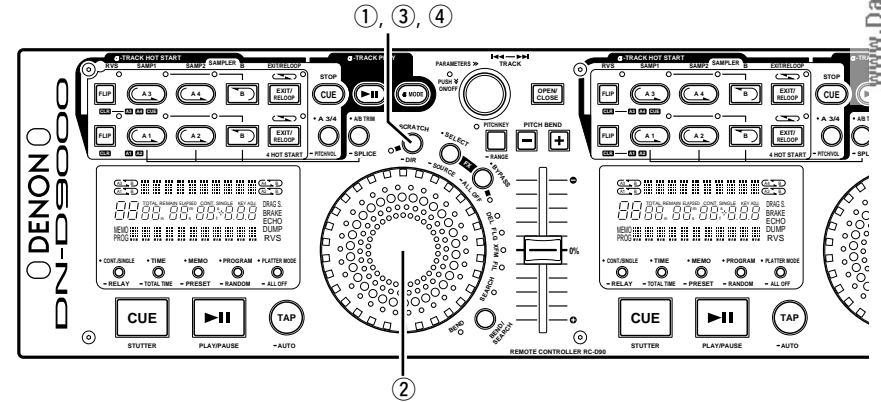
## 6 SCRATCH

You can scratch in CD or sampler mode. Also you can select the scratch sound direction to (turn direction of Jog Wheel), both, forward and reverse. These selections give you variety of scratch effects.



<b>1</b>	<p><b>SCRATCH PLAY</b></p> <ol style="list-style-type: none"> <li>1 Push the SCRATCH button to enter Scratch mode, SCRATCH LED flash.</li> <li>2 Turn the Jog Wheel to start scratching a specified point.</li> <li>3 To exit Scratch mode, push the SCRATCH button once again.</li> </ol>	  
<b>2-1</b>	<p><b>Select SCRATCH source and direction</b></p> <ol style="list-style-type: none"> <li>4 After the - DIR button pushed for more than 1 sec, combinations of scratch source and direction can be selected with the PARAMETERS knob.</li> </ol>	

<b>2-2</b>	<ul style="list-style-type: none"> <li>• DN-D9000 displays current setting as follows.                     <ul style="list-style-type: none"> <li><b>DISC/BOTH:</b> (default) Scratch Main with track both direction.</li> <li><b>DISC/FWD:</b> Scratch Main track with forward direction.</li> <li><b>DISC/RVS:</b> Scratch Main track only reverse direction.</li> <li><b>SAMP/BOTH:</b> Scratch Sampler sound with both direction.</li> <li><b>SAMP/FWD:</b> Scratch Sampler sound with forward only.</li> <li><b>SAMP/RVS:</b> Scratch Sampler sound with reverse only.</li> </ul> </li> </ul> <p>To use SAMP/BOTH, FWD, RVS scratch, Sampler setting is needed.</p>
------------	--

## 7 PLAYING THE ALPHA TRACK (Real Time Sampler)

- The Alpha-Track function lets you play one more track (the Alpha-Track) while playing the main track.
- The Alpha-Track's pitch and sound level can be adjusted.
- You can switch output channel of Alpha-Track sounds from MAIN OUT (default) or MONITOR OUT with the presets.
- You can use this function like a Sampler from Alpha-Cue point (Real time sampler). When the MONITOR OUT is selected, DN-D9000 can playback up to four songs simultaneously.

**NOTE:** The sampler and Alpha-Track functions cannot be used simultaneously.

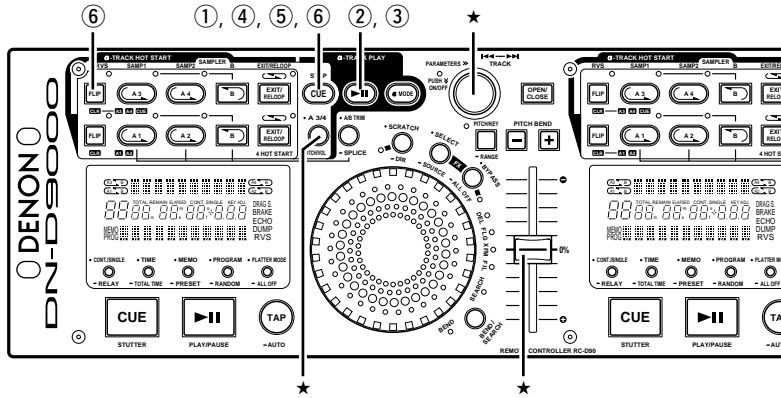

### Adjust sound level and pitch

The Alpha-Track and sampler playback sound level and pitch can be adjustable.

- ★ (1) Push the **PARAMETERS** button for more than 1 sec, the pitch input mode is selected, **PARAMETERS** LED flashes and the current settings are displayed on the character display.
- (2) Push the **PARAMETERS** button again to selected the sound level output mode.
- (3) Start Alpha-Track or sampler playback.
- (4) Turning the **PARAMETERS** knob can change the sound level or pitch.
  - \* When pushing down and turning the **PARAMETERS** knob, you can change the pitch range 10 times faster.
- (5) Push the **PARAMETERS** button again to turn the playing parameter mode off.

Unless you adjust Alpha-Track pitch separately, the Alpha-Track's pitch will be the same as your main track. In this case, pitch of both main track and Alpha-Track changes together when you move the main Pitch Slider.

<b>1</b>	<p><b>Enter Alpha-Track mode</b></p> <p>① When main track is in the standby or playing, push the ALPHA-CUE button to set the Alpha-Cue point. The ALPHA-CUE button lights up red.</p>
<b>2</b>	<p><b>Start Alpha-Track playback</b></p> <p>② Push the ALPHA-PLAY/PAUSE button to start Alpha-Track playback. When playback starts, the ALPHA-PLAY/PAUSE button lights up green.</p>
<b>3</b>	<p><b>Pause Alpha-Track playback</b></p> <p>③ During Alpha-Track playback, push the ALPHA-PLAY/PAUSE button to pause playback. When the pause mode is set, the ALPHA-PLAY/PAUSE button starts flashing.</p>

<b>4</b>	<p><b>Back Cue Alpha-Track playback</b></p> <p>④ In the Alpha-Track playback or pause mode, push the ALPHA-CUE button to Back-Cue. The ALPHA-CUE button lights up red.</p> <p><b>NOTE:</b> That the Alpha-Cue point is not changed automatically with start playback.</p>
<b>5</b>	<p><b>Stutter play the Alpha-Track</b></p> <p>⑤ In the Alpha-Track standby mode, push the ALPHA-CUE button to start stuttering.</p>
<b>6</b>	<p><b>Clear Alpha-Track</b></p> <p>⑥ While pushing the (RVS)/FLIP/(CLR) button, push the ALPHA-CUE button to clear the Alpha-Cue point.</p>

## 8 ALPHA MODE (Alpha-Track Monitor)

This function lets you play the Alpha-Track from MONITOR OUT while playing the main track. Using this function, you can prepare the next song on same CD before the end of your first track. While in Alpha-Mode, Alpha-Track's output can be monitored through your mixers headphone. Therefore, you can switch between the Alpha-Track and main track at any time, so two tracks on the same disc can be played continuously with no break in the sound.

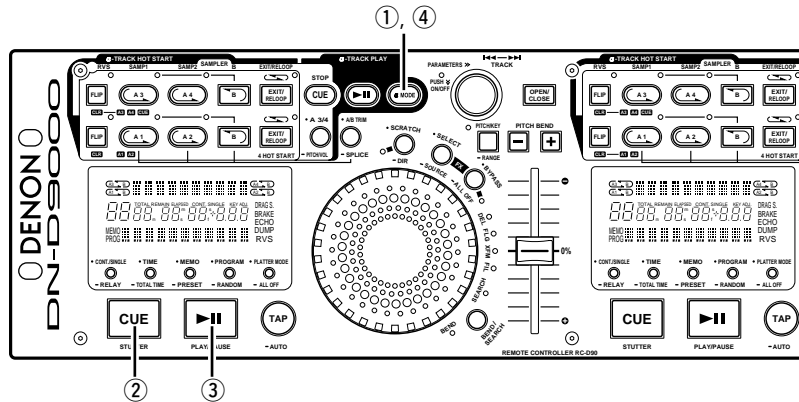

<b>4</b>	<p><b>Pitch after switching</b></p> <ul style="list-style-type: none"> <li>• Pitch of Alpha-Track can be changed separately from the main track. This causes the playback pitch to be different from the Pitch Slider setting after switching to Alpha-Track because the Pitch Slider was set originally for your main track.</li> <li>• In this case, PITCH LED flashes to warn that the Pitch Slider setting is different. Only until the position of the Pitch Slider matches its correct pitch of your Alpha-Track will the PITCH LED stop flashing and start changing with the Pitch Slider.</li> </ul>
<b>5</b>	<p><b>Exit from Alpha-Mode</b></p> <p>④ You can exit from Alpha-Mode with push ALPHA-MODE button.</p> 
<b>6</b>	<p><b>Hot Start, Sampler</b></p> <ul style="list-style-type: none"> <li>• Hot Start and Sampler setting with A1, A2, A3, A4 are available as Hot Start in Alpha-Mode.</li> </ul>

<b>1</b>	<p><b>Enter Alpha-Mode</b></p> <p>① Push the ALPHA-MODE button to enter Alpha Mode.</p>  <p><b>NOTE:</b> Before entering the Alpha-Mode, Samplers 1 and 2 (A3, A4 buttons) must be in the STOP mode otherwise the DN-D9000 will not accept the ALPHA-MODE command.</p> <p>* In the Alpha-Mode, illumination of ALPHA-MODE button flashes.</p>
<b>2</b>	<p><b>Monitor the Alpha-Track</b></p> <ul style="list-style-type: none"> <li>• You can execute many functions almost same as for the main track except Platter Effects, Program, Random. Without these functions you can prepare preferred sound and mixing point.</li> <li>• In Alpha-Track mode, the display information is dominated by Alpha-Track.</li> </ul>
<b>3-1</b>	<p><b>Switching Alpha-Track and main track</b></p> <ul style="list-style-type: none"> <li>• After you prepared your Alpha-Track, you can switch the sound between Alpha-Track and main track.</li> </ul>

<b>3-2</b>	<p>② When your main track is Cued in Alpha-Mode, CUE button illumination flashes rapidly. At this time you can switch between Alpha-Cue point and main Cue point, then CUE button stops flashing and waits for your next command.</p> <p>③ When main track is playing and then Alpha-Mode + Alpha-Track is selected, the main PLAY/PAUSE button illumination flashes rapidly.</p> <p>At this time you can switch (slam-mix) to force the "MAIN OUT" to stop and the Alpha-Track to start by simply pushing the main PLAY/PAUSE button.</p>  <p>The sound from Alpha-Cue point is routed to MAIN OUT, then PLAY/PAUSE button stops flashing.</p> <p>* After Alpha-Track changed to main track, Alpha-Mode ends automatically and ALPHA-MODE button illumination turns off. You can repeat the cycle again.</p>
------------	---

## 9 SEAMLESS LOOP/HOT START/STUTTER AND SPLICE

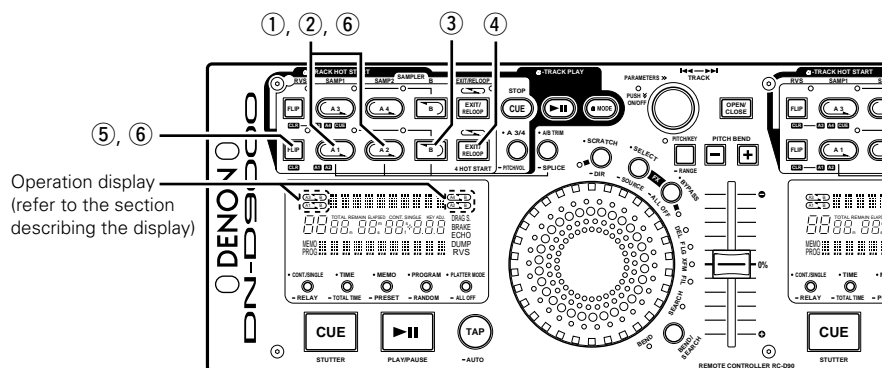

Operation display  
(refer to the section  
describing the display)

### Seamless Loop/Hot Start/Stutter (A1, A2 buttons)

<p><b>1</b></p> <p><b>Setting the A point (loading the Hot Start data)</b></p> <p>① Push the A1 or A2 button to set the A point and Hot Start data loading starts.</p> <ul style="list-style-type: none"> <li>A1 and A2 buttons can be used separately for each Hot Start.</li> <li>When an A point is set, the corresponding A button and FLIP LED light and that button is set to the Hot Start mode.</li> <li>The BPM is set independently for each hot start.</li> </ul>	<p><b>3-2</b></p> <ul style="list-style-type: none"> <li>If the B button is pushed during seamless loop playback or after EXIT playback, the B point moves to the point at which the button was pushed.</li> <li>When the B point is set, the B and LOOP LEDs light.</li> </ul>
<p><b>2</b></p> <p><b>Starts Hot Start</b></p> <p>② When A1 or A2 button is pushed, Hot Start playback starts from the corresponding A point.</p>	<p><b>4</b></p> <p><b>Playing seamless loops</b></p> <ul style="list-style-type: none"> <li>When the B point for A1 is detected after playback started from A1 point, playback returns to A1 point with seamless. While A1 to B looping, B point for A2 ignored.</li> <li>When the B point for A2 is detected after playback started from A2 point, playback returns to A2 point with seamless. While A2 to B looping, B point for A1 ignored.</li> </ul>
<p><b>3-1</b></p> <p><b>Setting the B point for Seamless Loop</b></p> <p>③ When the B button is pushed after setting the A point or after starting Hot start playback, the B point is set and Seamless Loop playback starts from the A point.</p> <ul style="list-style-type: none"> <li>The B button works with respect to the A point operated before the B button was pushed.</li> </ul>	<p><b>5</b></p> <p><b>Exit/ReLoop</b></p> <p>④ In Seamless Loop playback, you can force exit from or return in the loop.</p> <p><b>EXIT:</b> While the Seamless Loop playback, push the EXIT/RELOOP button to exit from loop. DN-D9000 continues playback after the B point.</p> <p><b>RELOOP:</b> When the EXIT/RELOOP button is pushed after exit the loop, Seamless Loop playback resumes from the A point.</p>

### Stutter

- A1 and A2 points can be also used for Stutter playback.

**6**

⑤ To enable stutter playback, push FLIP button for A1/A2 buttons, then FLIP LED turns off.

Press the FLIP button to switch between the Hot Start/Seamless Loop and Stutter modes.



### Clear the A1/A2 point

**7**

⑥ While pressing the FLIP/(CLR) button, push the A1 or A2 button to clear the corresponding A and B points.



Or push the Flip button for more than 1 sec to clear both A1 and A2 points at once.



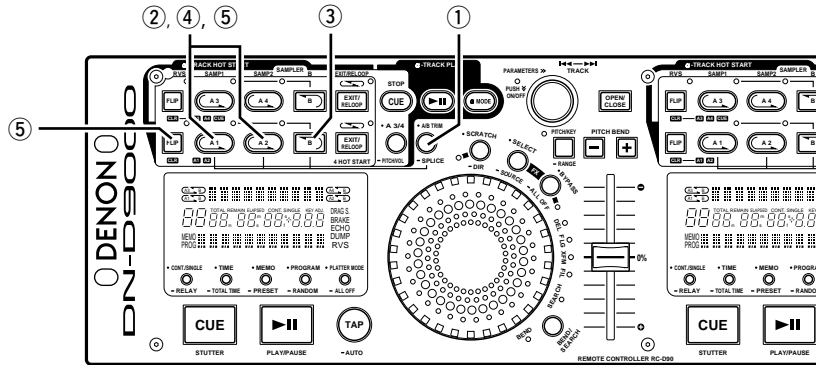

**Splice**

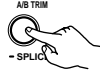
- Use this function to skip a section between A and B points. The A point is the point from which jumping starts, the B point the point at which jumping ends.
- The A1 and A2 Hot Starts and Stutter functions cannot be used if both Splice points are set in the Splice mode.



<b>1</b>	<p><b>Splice point setting mode</b></p> <p>① Push the SPLICER button for more than 1 sec to enable setting Splice point using A1, A2 and B buttons.</p> <ul style="list-style-type: none"> <li>• The A button illumination flashes when the Splice mode is set.</li> <li>• The Splice point setting cannot be set for the A point at which Hot Start data is already loaded.</li> </ul> 
<b>2</b>	<p><b>Set splice start point A</b></p> <p>② After starting playback, push the A1 or A2 button. The corresponding A button lights up and that point is set as splice start point A, and B LED start flashing.</p> 
<b>3</b>	<p><b>Set splice end point B</b></p> <p>③ After setting splice start point A, push the B button. The B LED lights up and that point is set as splice end point B.</p> 
<b>4</b>	<p><b>Start splice playback</b></p> <p>Start playback from any point before point A. When point A is reached, the section from point A to point B is jumped seamlessly and playback continues.</p>

<b>5</b>	<p><b>Temporarily turning off the splice playback</b></p> <p>④ When the corresponding A button is pushed after setting splice points A and B, the A button illumination turns off and the Splice play mode is temporarily turned off.</p> <ul style="list-style-type: none"> <li>• Push the corresponding A button again to resume splice playback.</li> </ul> 
<b>6</b>	<p><b>Clearing the splice points</b></p> <p>⑤ While pressing the FLIP/(CLR) button, push the corresponding A button to clear splice points A and B.</p>   <ul style="list-style-type: none"> <li>• When the splice points are cleared, the A button is set back to the hot start mode.</li> </ul>

# 10 A/B TRIM

- The seamless loop, sampler loop and splice A and B points can be fine-adjusted using Jog Wheel.
- There are two ways for doing this.  
 A-B Trim: Trim the points during loop playback as a rehearsal.  
 A/B Move: Move the points using the Manual Search. A/B Move can not be used with Sampler loop.

## A/B TRIM

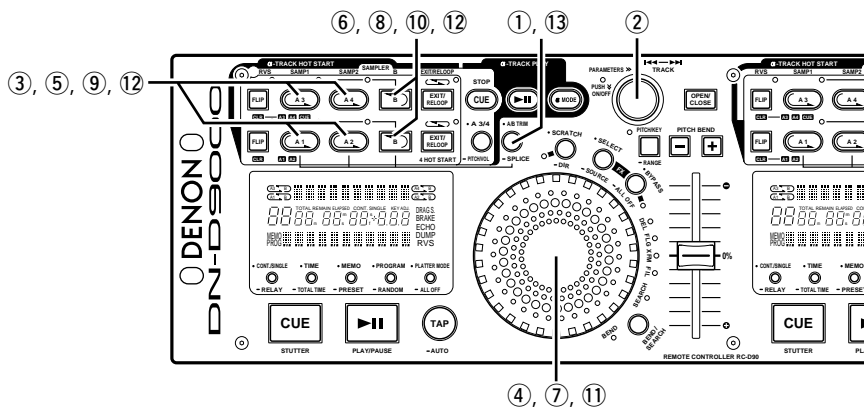

**Select A-B trim mode**  
 First select whether to adjust the A and B points using the A-B trim mode or the A/B move mode.

**1** Push the A/B TRIM button to set the A and B point position adjustment mode.

**2** Now turn the PARAMETERS knob to select the A-B Trim or the A/B Move.

**Select A point (in A-B Trim)**

**3** Select the A-B Trim and push the corresponding A button for the loop to be trimmed. The A button illumination flashes and loop playback starts.

- In the splice trim mode, total 6 seconds of spliced section (started from 2 seconds before A point to 4 seconds after the B point) is played.

**Trim A point**

**4** Turn the Jog Wheel to move the A point 1 frame at a time.

- Range for trimming A point is limited as follows.  
 A point for Loop: ±30 frames from the original A point. (However, when the A point was loaded from the standby mode, the A point cannot be moved backwards. So, use A/B Move function)  
 A point for Splice: Between the beginning of the disc and 5 frames before B point.  
 A point for Sampler: Between the original A point and 5 frames before B point.

**4** Save the A point

**5** Push the A button again to save new A point, and the unit automatically exit from the A-B Trim mode.

**Select B point (in A-B Trim)**

**5** Select the A-B Trim mode and to select the B point, push the B button after selecting the A point. Then push the B button. The B LED flashes and the B point trim become enable.

**Trim B point**

**6** Turn Jog Wheel to move the B point 1 frame at a time.

- Range for trimming B point is limited as follows.  
 B point for Loop: Between 5 frames after A point and disc end.  
 B point for Splice: ±30 frames from the original B point. (However, when the B point was loaded from the standby mode, the B point cannot be moved backwards. So, use A/B Move function)  
 B point for Sampler: Between 5 frames after A point and sampler end.

**7** Save the B point

**8** Push the B button again to save new B point, and the unit automatically exit from finish the A-B Trim mode.

**A/B Move**

**Select A and B points**

**8** Select or the A/B Move and push the A button for the A point you want to move. The standby mode is set at the A point and the A button illumination flashes.

**9** To select the B point, push the B button after selecting the A point.

- The B LED flashes. The Selected B point is used for the A1 or A2 point that was first selected.

**Move A or B points**

**10** Turn the Jog Wheel to move the selected point using the Manual Search function.

- Range for moving A point is limited as follows.  
 A point for Loop: Between the beginning of the disc and 5 frames before B point.  
 A point for Splice: Between the beginning of the disc and 5 frames before B point  
 B point for Loop: Between 5 frames after A point and disc end  
 B point for Splice: Between 5 frames after A point and disc end
- Range for moving B point is limited as follows.  
 B point for Loop: Between 5 frames after A point and disc end  
 B point for Splice: Between 5 frames after A point and disc end

**11** Save the A or B points

**12** Push the A1/A2 or B button again. The LED stops flashing and the A1/A2 or B point is saved, and the unit automatically exit from the A/B Move mode.

**13** Cancel the A-B Trim or A/B Move

**11** Push the A/B TRIM button to cancel the mode.



# 11 A3/A4 FOR SAMPLER, 4 HOT START, ALPHA-TRACK HOT START

The buttons of A3, A4 and corresponding FLIP, B and EXIT/RELOOP are used for Sampler, 4 Hot Start and Alpha-Track Hot Start functions.

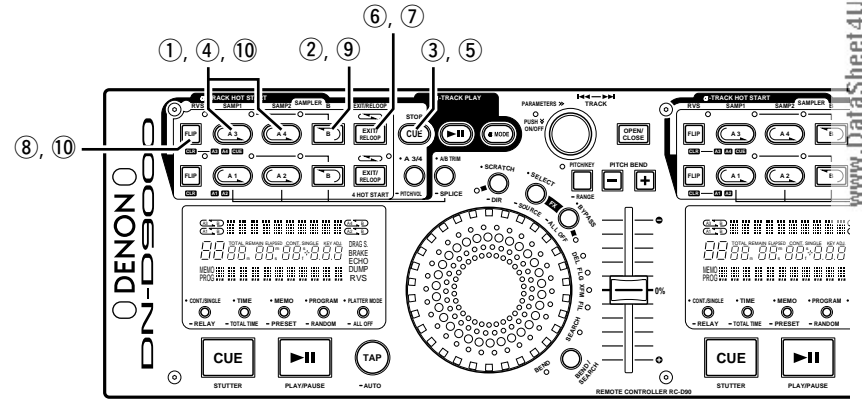
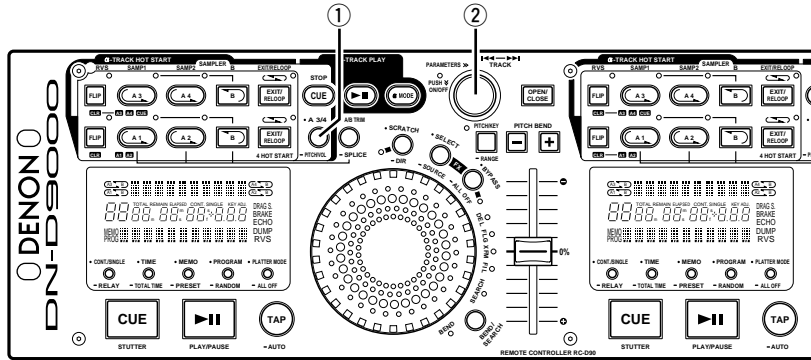

## Sampler

DN-D9000 has four Samplers (two Samplers for each drive) of 15 seconds length. These Samplers are also used in looping playback.

### A3/A4 mode

#### Select A3/A4 Mode

The A3 and A4 buttons can be used for one of the three modes described below.

- Sampler mode
- 4 Hot Start mode (A1, A2, A3 and A4)
- Alpha-Track Hot Start mode

1 When the **A 3/4** button is pushed, the operating mode can be selected with the **PARAMETERS** knob. The **PARAMETERS** LED flashes and the A3/A4 mode is displayed on the character display.



2 Turn the **PARAMETERS** knob and select the A3/A4 button mode, then push the **PARAMETERS** knob to set.

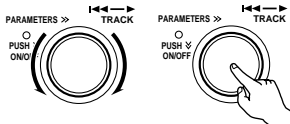

#### Sampler mode:

The A3 and A4 buttons lights up in green.

- In Sampler mode, A3 button used for Sampler1 and A4 buttons are used for Sampler2.
- The sampled data is stored in the memory, even when the mode is changed.

#### 4 Hot Start mode:

The A3 and A4 buttons light up in orange.

- Like the A1 and A2 buttons, the A3 and A4 buttons are also used for Hot Start, Stutter and Seamless loop playback. Then total 4 Hot Start points can be set, one each at buttons A1, A2, A3 and A4.
- The A3 and A4 points set in the 4 Hot Start mode can be used in Alpha-Track Hot Start mode as well.

#### Alpha-Track Hot Start mode:

The A3 and A4 buttons light in green.

- Like the A1 and A2 buttons, the A3 and A4 buttons are also used for Hot Start, Stutter and Seamless loop playback. However, A3 and A4 Hot Start is played for the Alpha-Track.
- The A3 and A4 points set in the Alpha-Track Hot Start mode can be used in the 4 Hot Start mode as well.

#### Record in Sampler

- 1 When the **SAMP** button (SAMP1 (A3) or SAMP2 (A4)) is pushed in the standby or playing, the sound from A3 or A4 point is recorded to Sampler memory up to 15 seconds.
- The SAMP1 or SAMP2 button is flashing while recording. When the recording is completed, the button turns off and the corresponding SAMP B LED lights up.



#### Setting B point

- 2 When the **B** button is pushed during Sampler recording, the Sampler Loop B point is set and the loop mode turns on.
- Recording continues for approximately 15 seconds without stopping after set B point.
  - If the B point is not set, recording end point set as B point automatically. Also **EXIT/RELOOP** LED light to indicates Sampler Loop mode is set automatically.

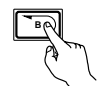

#### Stop recording

- 3 To stop recording before recording finish automatically with memory full, push the **STOP** (ALPHA-CUE) button.
- The **EXIT/RELOOP** LED light to indicates Sampler Loop mode is set automatically.



#### Play Sampler sound

- 4 Playback of the Sampler sound starts when the **SAMP** button is pushed after recording has stopped.
- Sampler playback continues in looping. With setting B point, playback loop between A and B point. Without B point setting Sampler loops whole recorded length (about 15 seconds).
- NOTE:** It is not possible to play Sampler1 and Sampler2 at the same time.



- 5 To stop the Sampler sound push **STOP** (ALPHA-CUE) button.







#### Select Sampler Loop mode

You can select loop mode for Sampler when sampler playback stop.

- Loop (default):  
Sampler playback continues with looping. (**EXIT/RELOOP** LED stays lit)
- Exit: Sampler playback continues over B point up to recording length. (**EXIT/RELOOP** LED flashes)
- Single: Sampler playback stops at B point. (**EXIT/RELOOP** LED turned off)

- 6 To select loop mode, push **EXIT/RELOOP** button after recording and before playing.



6	<p><b>Exit and Reloop</b></p> <p>⑦ The EXIT/RELOOP button can be used same as Seamless Loop function.</p> 
7	<p><b>Reverse Play</b></p> <p>⑧ You can play Sampler sound in reverse with push RVS (FLIP) button. In reverse play mode RVS LED lights up.</p> <ul style="list-style-type: none"> <li>Reverse playback will start with next playback starting after reverse mode turned on.</li> </ul> 
8	<p><b>Moving Sampler B point</b></p> <p>⑨ When the B button is pushed during sampler playback, the B point moves to the point at which the button was pushed, and loop playback from point A starts.</p> 
9	<p><b>Setting the sampler volume and pitch</b></p> <ul style="list-style-type: none"> <li>The sound level (volume) and pitch can be set individually for sampler1 and 2.</li> <li>See [7] - step 7 "Adjust sound level and pitch".</li> </ul>
10	<p><b>Clearing the Sampler data</b></p> <p>⑩ While pressing the (RVS)/FLIP/(CLR) button, push the SAMP button (SAMP1 or SAMP2) to clear the sampler.</p>  <ul style="list-style-type: none"> <li>By pushing the (RVS)/FLIP/(CLR) button for approx. 1 sec, you can clear both samplers 1 and 2.</li> </ul>

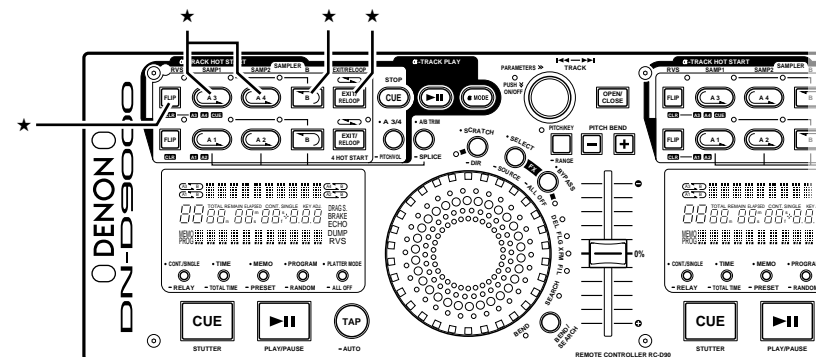

**Hot start mode**

Like with buttons A1 and A2, operation is performed using the (RVS)/FLIP/(CLR), A3, A4 and EXIT/RELOOP buttons. Operation is same as Hot Start with A1, A2 buttons. See page 14 for details.

**Alpha-track hot start mode**

Like with buttons A1 and A2, operation is performed using the (RVS)/FLIP/(CLR), A3, A4 and EXIT/RELOOP buttons. (Refer to page 14.)

## 12 PLATTER EFFECT

This function is only available for the main track.

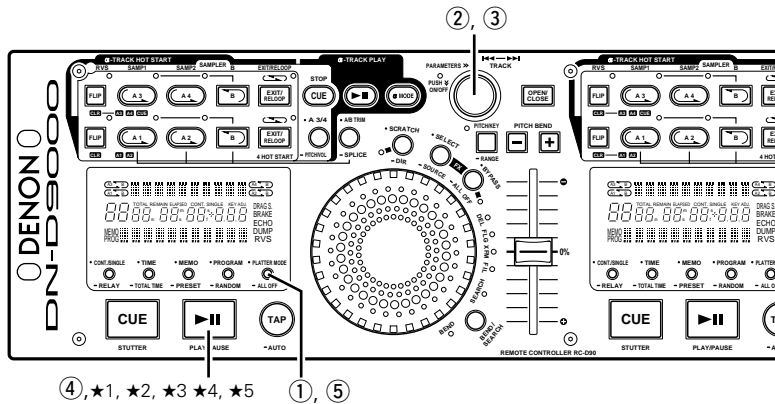

**Select the Platter Effect**

1-1

① Push the PLATTER MODE button and the PLATTER EFFECT select mode is selected. The mode switches as follows each time the button is pushed:

DRAG S. (DRAG START) → BRAKE → ECHO (TAIL ECHO) → DUMP → RVS → Exit from PLATTER MODE menu

- The PARAMETERS LED flashes and the Platter effect name and parameter are displayed.

**DRAG S., BRAKE, ECHO:**

If you use these 3 functions with default settings, there is a 4 second time out of inactivity for the PLATTER MODE button once selected and PARAMETERS knob if adjusted. After 4 seconds, selected Platter Effect starts working and DN-D9000 exits out of the Platter mode menu.

② Or after selecting the Effector you want to use, push the PARAMETERS knob to set "on" the selected Effector. Push again to turn "off".

- When the platter effect is on, the corresponding platter indicator lights up.

1-2

③ The PLATTER EFFECT parameter can be selected by turning the PARAMETERS knob.

**DUMP, RVS:**

④ In this mode each push of the PLAY/PAUSE button switches to turn the effect on or off.

**Platter Effect**

**DRAG S. (DRAG START):**

Simulates the dragging sound of a belt drive turntable starting up from a stop mode.

- The DRAG S. time can be selected with the PARAMETERS knob.
- ★1 The DRAG S. is activated when playback is started with the PLAY/PAUSE button.

**BRAKE:**

2-1

Simulates a winding-down sound of a vinyl turntable coming to a full stop slowly.

- The BRAKE time can be selected with the PARAMETERS knob.
- ★2 The BRAKE is activated when the PLAY/PAUSE button is pushed during playback.

**ECHO (TAIL ECHO):**

Adds a 1/1 echo sound when playback stops.

- The times of echoes can be set with the PARAMETERS knob.
- ★3 The ECHO is activated when the PLAY/PAUSE button is pushed during playback.

**CAUTION:**

While SAMPLER or ALPHA-TRACK is selected for Effector SOURCE, ECHO effect of Platter Effect is not turned on.

**DUMP:**

2-2

Reverse playback is performed for the specified time. Plays the sound backwards while continuing in a forward motion without losing "elapsed time" when you return back to normal (forward) play.

- ★4 Each pushing the PLAY/PAUSE button switches between DUMP playback and normal playback.
- The reverse play turns off when the hot start or stutter is started.

**RVS (REVERSE):**

- ★5 Each pushing the PLAY/PAUSE button switches between reverse playback and normal playback.
- The reverse play turns off when the hot start or stutter is started.

**Cancelling all the Platter Effects**

3

⑤ Push the ALL OFF (PLATTER MODE) button for more than 1 sec to cancel the all platter effects.

**13 EFFECTOR (FX)**

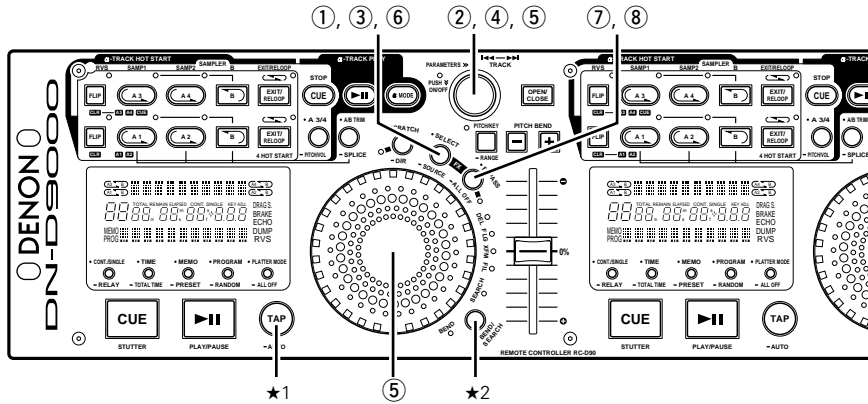

**1 Select the Effector source**  
First select the source to which you want to add sound Effector.

① Push the **SOURCE** button for more than 1 sec, then Effector source can now be selected with the **PARAMETERS** knob.

- The **PARAMETERS** LED flashes and "SOURCE" is displayed on the character display.

② Turn the **PARAMETERS** knob to select the source, then push the **PARAMETERS** knob to set that source.

- You can select from these two sources.
  - Main track (default)
  - Sampler or Alpha-Track

---

**2-1 Select the Effector mode**  
Next select the Effector to be used.

③ Push the **SELECT** button. The Effector mode switches as follows each time the button is pushed:

DELAY → FLANGER → XFM (TRANSFORM) → FILTER → Exit from EFFECTOR MODE menu

- The **PARAMETERS** LED flashes and the Effector name and parameter are displayed on the display.

④ After selecting the Effector you want, push the **PARAMETERS** knob to turn the Effector on. Push again to turn the Effector off.

⑤ Turn the **JOG Wheel** or the **PARAMETERS** knob to change the Effector's parameters and change the effect level.

★1 BPM is normally counted automatically, but you can input by tapping **TAP** button manually.

⑥ Now push the **SELECT** button to set the currently activated Effector to the hold mode. Another Effector can be selected.

There are four LEDs (DEL, FLG, XFM, FIL) for each Effector to indicate its status.

- LED lit: Effector working with hold mode.
- LED flashing: Effector working and being selected and adjustable.
- LED off: Effector is not working.

★2 Because **PARAMETERS (TRACK)** knob is assigned for Effector setting, Track select is disabled in this case. DN-D9000 has quick way to exit from Effector mode keeping Effector sound. To do this, simply push the **BEND/SEARCH** button. After exit you can return back to the Effector settings by pushing the **SELECT** button.

2-3

**Effectors**

**DELAY (DEL):**

- The **DELAY** time can be selected by turning the **PARAMETERS** knob. (1/32, 1/16, 1/8, 1/4, 1/2, 3/4, 1/1 or 2/1 of counted BPM)
- Number of delay sounds can be selected by turning the **Jog Wheel**. (From 0 (source sound only) to 22 (delay sound only))

**FLANGER (FLG):**

- FLANGER** time can be selected by turning the **PARAMETERS** knob. (1/8, 1/4, 1/2, 3/4, 1/1, 2/1 or 4/1 of counted BPM)
- The **FLANGER** feedback gain can be selected by turning the **Jog Wheel**.

**TRANSFORM (XFM):**

- "NORMAL" and "SAMPLER MIX" can be selected by turning the **PARAMETERS** knob.
- The muted "time" intervals may be selected by turning the **Jog Wheel** in either direction. Turn the **Jog** clockwise for the longest time or counter-clockwise for the shortest time, which will give you a "RING" type of effect.
- SAMPLE MIX** mode is intended to quickly switch output sounds between the **SAMPLER** and your **CD**. The loaded **Sample (A3, A4)** and the **CD** must be playing at the same time and in perfect sync with each other for maximum effect.

**FILTER (FIL):**

- "BAND CUT" or "BAND PASS" can be selected by turning the **PARAMETERS** knob.
- The filter frequency band can be selected by turning the **Jog Wheel**.

**4 Bypass the Effector**

⑦ You can bypass all Effector with pushing **BYPASS** button.

- One more push **BYPASS** button resumes the Effector.
- While bypassing, **BYPASS** LED flashes.

---

**5 Cancel the Effector**

⑧ Push the **ALL OFF (BYPASS)** button for more than 1 sec to cancel all the Effectors that were set on.

## 14 MEMO (Custom Setting Memory)

CD setting information can be stored in the non-volatile memory. The stored information can be called out of the memory later, making it easy to prepare for your mixing.

### 1. About MEMO

- Up to 5000 memo points can be stored to internal memory for later recall.  
The number of tracks on a particular CD only limits the amount of memo points available per that disc.  
Example: If your CD has 22 tracks, you can only save up to 22 memos. (1 memo group per track.)

#### CAUTION:

5000 is the maximum possible number of tracks that can be stored to memory.  
However, to simplify the MEMO operations, the memory system manages each 1250 MEMO data package as a minimum unit (the total 5000 memory capacity divided into 4 package units). When you want to clear just one MEMO data in the 1 MEMO CLEAR mode (see page 21), the unit will erase the memo information but not the internal memo allocation number. Accordingly, depending on conditions, the number of tracks that can be stored in the memory may be fewer than 5000.  
Once you reached 5000 stored points, you will see a message that says "MEMO FULL!". At this time you will need to "delete" old data to make room for new memo points. Therefore the oldest 1250 memo points will be deleted and become clear.

- Some data can be set and recalled from the memory in the Alpha-mode as well.
- The MEMO indicator on the display lights up when a track for which data is stored in the memory is selected.

### 2. MEMO ITEMS

The following items are max to be stored under 1 memory bank:

- Cue and Alpha-Cue point
- A1-B1 and A2-B2 points
- A3-B3, A4-B4 points and A3/4 mode (not stored in the sampler mode)
- Playing pitch, pitch on/off, Key Adjust on/off setting

### 3. MEMO MODE SELECT

- Push the MEMO button in Cue mode to enter MEMO mode.
- Turn the PARAMETERS knob to select the various MEMO modes from as follows.

#### Memo Set, MemoCall, Memo Ctr

Depending on conditions, some modes cannot be selected.

- Push the MEMO button again to exit MEMO mode.

#### (1) Storing data in the memory [Memo Set]

- After make the settings to be stored in the memory, then push CUE button.
- When MEMO indicator on the display is off in Cue mode, push MEMO button to enable Memo set function.
- If MEMO indicator lights up, it is necessary to clear existing Memo before store new Memo.
- At last push PARAMETERS knob to fix. You can see "COMPLETE" message and MEMO indicator lights up.

#### MEMO FULL

- If the memory is full and no more data can be stored, "Memo Full!" and "Del 1250?" message appears.
- In this case, you need to clear memory of First 1250s Memo (number 1 to 1250) at a time to make space for new memos.
- To make space, push PARAMETERS knob while "Del 1250?" message is displayed.
- "Delete OK?" message appears then push PARAMETERS knob again to execute clearing.
- After the first 1250s Memo (number 1 to 1250) are cleared, number after 1251 Memo are renumbered as new 1, 2, 3...(now you have new 1250 empty space.).

#### (2) MEMO Call [Memo Call]

- When the CD includes tracks that DN-D9000 has Memo is inserted, MEMO indicator flashes 5 seconds.
- To call out the Memo data, select the track that you made MEMO. Then MEMO indicator lights up.
- Push the MEMO button to enable Memo call function.
- When the PARAMETERS knob is pushed in the Memo call mode, all the data stored in the memory is loaded. DN-D9000 goes to standby mode at the called Cue point.

- When the playing pitch is loaded from the Memo with PITCH LED flashes, playing Pitch is locked until Pitch Slider comes same Pitch. While playing Pitch is locked, PITCH LED keeps flashing.

#### Memo Call in Alpha-Mode

- In the Alpha-Mode, Memo call function can be used when main track is not Cue. And Memo call function can be used without changing the main track operations.

### (3) 1 MEMO CLEAR [Memo Ctr]

- To clear one Memo data, select the track that you made MEMO. Then MEMO indicator lights up.
- Push the MEMO button to enable Memo clear function.
- When the PARAMETERS knob is pushed in MEMO CLEAR mode, the Memo data is cleared and the MEMO indicator on the display turns off.

#### ALL MEMO CLEAR

- All memory data can be cleared.
- For instructions, see "[F5] PRESET (12) All MEMO CLEAR".

### 4. Copying all MEMO

- The MEMO data can be copied between DN-D9000s.
- Also DN-2600F MEMO data can be copied onto the DN-D9000.
- For instructions, see "[F5] PRESET (13) MEMO ALL COPY".

# 15 PRESET

## 1. Preset mode

- ① The preset mode is available when PRESET button is pushed for more than 1 sec while DN-D9000 is in Cue, pause or no disc mode.
- ② Turn the PARAMETERS knob to select the preset item.
- ③ After selecting an item, push the PARAMETERS knob to select the preset data.
- ④ To change other Preset items, repeat these steps.
- ⑤ Push the PRESET, CUE or PLAY/PAUSE button to exit from the Preset mode.

## 2. Preset items and data

The "\*" mark next to the data indicates the default value.

- (1) AUTO CUE: Auto Cue level search on/off.  
ON\* / OFF
- (2) PITCH RANGE: Select the playing pitch range when the power is turned on.  
±4 / ±10\* / ±16 / ±24%
- (3) ALPHA-TRACK OUTPUT: Alpha-Track playback output destination.  
Main out\* / Monitor out
- (4) AUTO CLOSE: Time for automatically closing disc holder.  
OFF / 10 / 30\* / 60 seconds
- (5) EOM: Track end message start time.  
OFF / 10\* / 15 / 20 / 30 / 60 / 90 seconds
- (6) Alpha-Track FADER START: Select the Alpha-Track fader Start ON/OFF.  
ON / OFF\*
- (7) FADER: Select 2-line type (Cue and Play) or 1 line type (Play and Pause).  
PLAY/CUE\* / PLAY/PAUSE
- (8) POWER ON PLAY: Playback starts when the power is turned on if a disc is loaded.  
ON / OFF\*
- (9) A3/4 MODE: Select the A3 and A4 button operating modes when the power is turned on.  
Sampler\* / 4H/S / Alpha-Track H/S
- (10) SINGLE/CONTINUOUS: Select the play mode when the power is turned on.  
SINGLE\* / CONTINUOUS
- (11) ELAPSED/REMAIN: Select the time mode when the power is turned on.  
ELAPSED\* / REMAIN
- (12) PROGRAM ALL CLEAR: Clear all program play data in the non-volatile memory.  
**NOTE:** This Preset item can be only performed in CD1 (left side) of the remote controller.  
  - ① To clear the program, push the PARAMETERS knob and select "YES".
    - "Clear OK?" flashes on the character display.
  - ② Push the PARAMETERS knob again and select "OK" to execute clearing the program.  
"Prog. Clear" is displayed on the character display while data clearing.
  - ③ Once clearing is completed, "Complete!" is displayed.
- (13) MEMO ALL CLEAR: Clear all MEMO data in the non-volatile memory.  
**NOTE:** This Preset item can be only performed in CD1 (left side) of the remote controller.  
  - ① To clear all MEMO data, push the PARAMETERS knob and select "YES".
    - "Clear OK?" flashes on the character display.
  - ② Push the PARAMETERS knob again and select "OK" to execute clearing all MEMO data.  
• "Memo Clear" is displayed on the character display while clearing.
  - ③ Once clearing is completed, "Complete!" is displayed.
- (14) MEMO ALL COPY: Copy all MEMO data from the master unit of DN-D9000 (or DN-2600F) to the slave unit of DN-D9000 when both unit are connected by the specified Cross Cable. (See diagram for the cable.)  
**NOTE:** This Preset item can be only performed in CD1 (left side) of the remote controller. Also, be sure that both disc trays are open, or both have no discs inside.

A cross cable used:

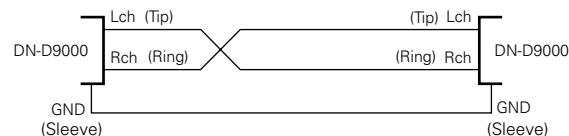

- Using the cross cable, connect the X-EFFECT terminals between two DN-D9000 units or between one DN-2600F and one DN-D9000 unit.
- If a DN-2600F is the master unit, take the procedures below in the Preset mode of the DN-2600F beforehand. (For details, refer to the DN-2600F's operating instructions.)  
\* Set the "Copy Master" for the Preset item (14).  
Then, step to the ① below on the slave unit of DN-D9000.

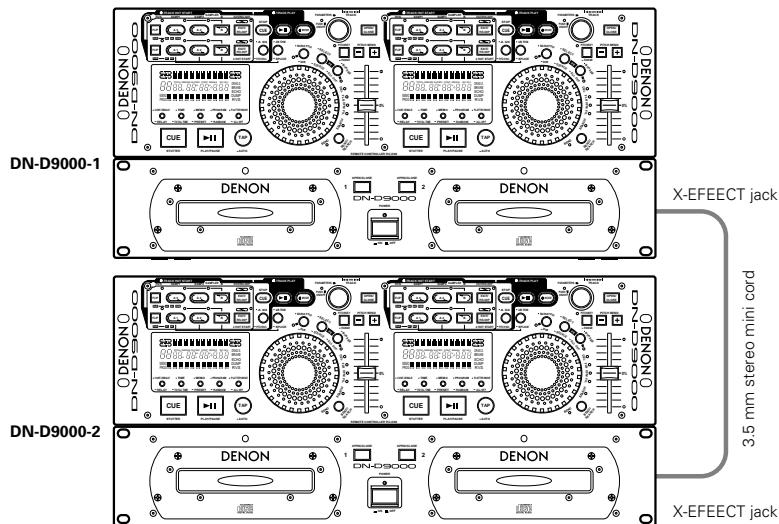

- Perform the copying operation as below on the slave unit of DN-D9000.
  - ① To start copying, push the PARAMETERS knob and select "YES". Now "Copy OK?" messages flashes on the character display.
  - ② Push the PARAMETERS knob again to confirm. Now "Start OK?" is displayed.  
**NOTE:** If a DN-2600F is the master unit, take the procedures below in the Preset mode of the DN-2600F here.  
In the Preset item (15), first start copying on the DN-2600F. Then, step to ③ below on the slave unit of DN-D9000.
  - ③ Push the PARAMETERS knob once again, and the unit starts copying when the MEMO data are received from the master unit. Now "Copying" is displayed.
    - If the master unit and the slave unit are not connected properly or the DN-2600F is not prepared to start sending data, "Not Connect" is displayed on the character display.
  - ④ When copying is completed correctly, "Complete!" is displayed.
    - "Copy Error" is displayed on the character display if copying was not completed correctly.  
In this case, try the above procedure again.
    - The copied MEMO data are added to the highest number area of the slave DN-D9000 unit.
- (15) PRESET CLEAR: Set all the preset data back to the factory defaults.
  - ① To clear the PRESET data, push the PARAMETERS.  
"Initial OK?" flashes on the character display.
  - ② Push the PARAMETERS knob again and select "OK" to start clear the preset data.  
"Preset Int" is displayed on the character display while data clearing.
  - ③ Once clearing is completed, "Complete!" is displayed.

# 16 PROGRAM/RANDOM/RELAY PLAY/POWER ON PLAY

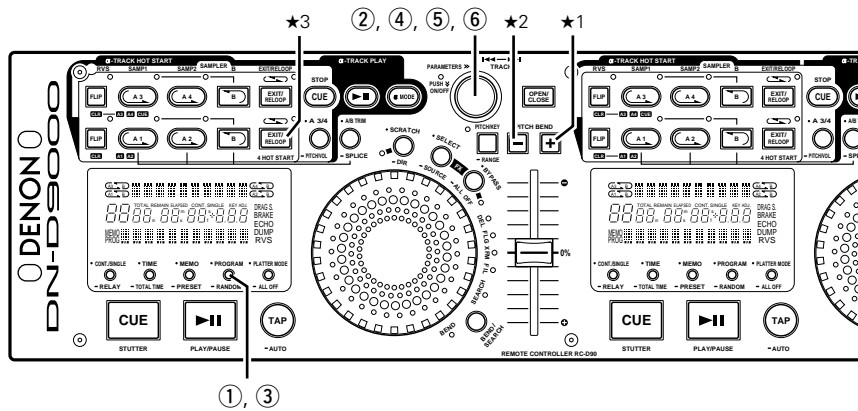

## Program Play

- Up to 25 tracks from one disc can be programmed.
- Programs for up to six discs (one program per disc) can be stored in the non-volatile memory for later recall.

**NOTE:** Such functions as Hot Start, Sampler, Effector and Platter Effect do not operate during programmed playback.

### Program mode select

- ① Push the PROGRAM button in Cue or pause mode to enter Program mode.
- ② Turn the PARAMETERS knob to select the various program setting modes as follows.

#### Prog.In, Prog.On, Prog.Off, MemoSet, MemoCall, MemoClr

Depending on conditions, some modes cannot be selected.

- ③ Push the PROGRAM button again to exit program mode.

**1-1**

**Input Program (Prog.In)**  
Input the program for program playback.

- ④ Turn the PARAMETERS knob to select the track.

- ⑤ Push the PARAMETERS knob to input the selected track to the program.

**★1 Insert Tracks to Program**

- You can insert tracks to the previously programmed tracks.
- One track can be inserted at a time using the PITCH BEND + button and return step 1.

**1-2**

**★2 Clear Tracks from Program**

- You can clear tracks from the previously programmed tracks.
- One track can be cleared at a time using the PITCH BEND - button.

- ⑥ Push the PARAMETERS knob again to return step 1-④.

- 2

- Repeat these steps to input whole program.
- Push the PROGRAM button to end the program input mode, then proceed to Start Program Play (Prog.On).

<b>3</b>	<p><b>Start Program Play (Prog.On)</b></p> <ul style="list-style-type: none"> <li>• When "Prog.On" is selected, DN-D9000 will cue up at the first track in the program.</li> <li>• Program playback starts when the PLAY/PAUSE button is pushed.</li> </ul> <p>★3 You can use program repeat play function with push EXIT/RELOOP button.</p>
<b>4</b>	<p><b>Cancel Program mode (Prog.Off)</b></p> <ul style="list-style-type: none"> <li>• When "Prog.Off" is selected, the program play mode turns off and returns to normal play mode.</li> </ul>
<b>5</b>	<p><b>Store Program (MemoSet)</b></p> <ul style="list-style-type: none"> <li>• When "Memo Set" is selected, the program that has been set is stored in the non-volatile memory.</li> </ul>
<b>6</b>	<p><b>Call Program (MemoCall)</b></p> <ul style="list-style-type: none"> <li>• When "MemoCall" is selected, the program stored in the non-volatile memory is loaded and the program play mode is set.</li> </ul>
<b>7</b>	<p><b>Clear Program (MemoClr)</b></p> <ul style="list-style-type: none"> <li>• When "MemoClr" is selected, the program for the loaded disc is cleared.</li> <li>• To clear all Program Memo use Preset function.</li> </ul>

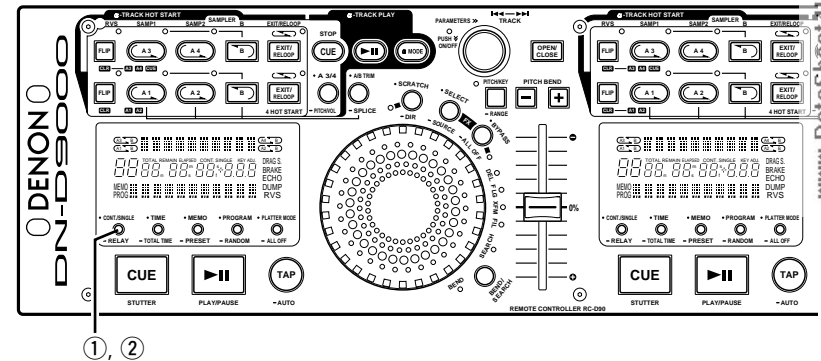
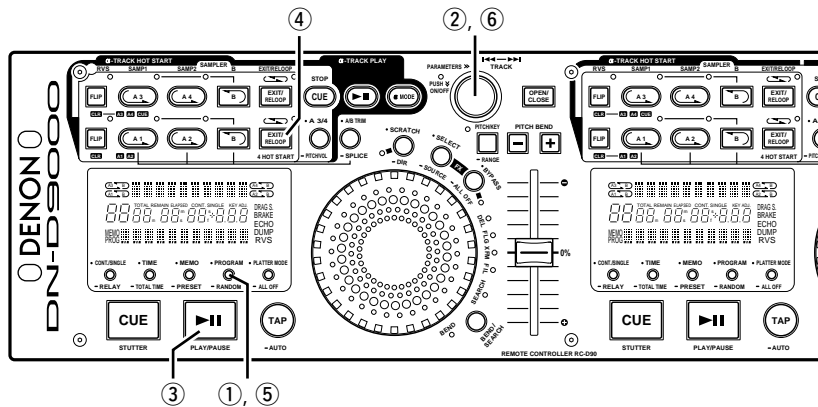

**Random Playback**

- With the random play function, tracks are selected at random and played from the discs in both players (CD1 and CD2).

**NOTE:** Such functions as Hot Start, Sampler, Effector and Platter Effect do not operate during random playback.

**Random Play mode (Random On)**

- In the Cue or pause mode, push the RANDOM button for more than 1 sec to select "Random On".
- Push PARAMETERS knob to set the random play mode. The unit will standby at a track selected at random.

**Start Random Play**

- Push the PLAY/PAUSE button on the player that is in the standby mode to start random playback.
  - The random play mode is turned off when the disc holder for either CD1 or CD2 is opened while in standby mode.
- You can use random repeat play function by pushing the EXIT/RELOOP button.

**Cancel Random Play (RandomOff)**

- "RandomOff" can be selected when the RANDOM button is pushed during random playback.
- Push PARAMETERS knob to cancel Random play. The unit will return to the normal play mode.

**Relay playback**

- Relay Play function is a playback mode to continue play tracks of CDs in both player left and right.

**Start Relay Play**

- Push the RELAY button for more than 1 sec to enable Relay play mode. You can set Relay mode as below.
  - In the single play mode, when the one player's playback reaches end of track, another player starts playing.
  - In the continuous play mode, when the whole tracks on one side are finished, another player starts.
  - The discs in CD1 and CD2 can be played alternately by setting both CD1 and CD2 to the relay play mode.

**Stop Relay Play**

- When the RELAY button is pushed for more than 1 sec while in the relay play mode, the relay play mode is turned off.

**Power On Play**

- When "POWER ON PLAY" is set to "ON" at "19 PRESET (7)", playback starts from the first track on the disc when the power is turned on.



## 17 SPECIFICATIONS

### GENERAL

<b>Type:</b>	Twin mechanism compact disc player with wired remote control	
<b>Disc type:</b>	Standard compact discs (12 cm discs) CD-R, CD-RW discs	
	<b>NOTE:</b> Finalized CD-R or CD-RW discs can be played back in this unit. However, according to recording quality, some CD-R/RW discs cannot be played.	
<b>Dimensions:</b>	Player unit:	482 (W) x 88 (H) x 252 (D) mm (without feet) 18-31/32" (W) x 3-15/32" (H) x 9-59/64" (D)
	Remote control unit:	482 (W) x 132 (H) x 40 (D) mm (without feet) 18-31/32" (W) x 5-13/64" (H) x 1-37/64" (D)
<b>Installation:</b>	19-inch rack mountable	
	Player unit:	2U
	Remote control unit:	3U
<b>Mass:</b>	Player unit:	8 kg (17 lbs 10 oz)
	Remote control unit:	4 kg (8 lbs 13 oz)
<b>Power supply:</b>	U.S.A., Canada and Taiwan R.O.C. models: 120 V AC $\pm 10\%$ , 60 Hz European models: 230 V AC $\pm 10\%$ , 50 Hz	
<b>Power consumption:</b>	33 W	
<b>Environmental conditions:</b>	Operational temperature:	5 to 35°C (41 to 95°F)
	Operational humidity:	25 to 85% (no condensation)
	Storage temperature:	-20 to 60°C (4 to 140°F)

### AUDIO SECTION

<b>Main out, Monitor out</b>	
<b>Quantization:</b>	24-bit linear per channel
<b>Sampling frequency:</b>	44.1 kHz at normal pitch
<b>Oversampling rate:</b>	8 times
<b>Total harmonic distortion:</b>	0.01% or less
<b>Signal to noise ratio:</b>	90 dB or more
<b>Channel separation:</b>	85 dB or more
<b>Frequency response:</b>	20 to 20,000 Hz
<b>Analog output</b>	
<b>Main output level:</b>	2.0 V r.m.s.
<b>Monitor output level:</b>	2.0 V r.m.s.
<b>Load impedance:</b>	10 k $\Omega$ /kohms or more
<b>Digital output</b>	
<b>Signal format:</b>	SPDIF
<b>Output level:</b>	0.5 Vp-p 75 $\Omega$ /ohms

### FUNCTIONS

<b>Instant start:</b>	Within 20 msec.
<b>Variable pitch</b>	
<b>MAIN, <math>\alpha</math> TRACK:</b>	$\pm 4\%$ (0.05% pitch), $\pm 10\%$ (0.1% pitch), $\pm 16\%$ (0.1% pitch) $\pm 24\%$ (0.1% pitch), $\pm 100\%$ (1.0% pitch): Main playback only
<b>Pitch bend:</b>	Pitch range $\pm 4\%$ , $\pm 10\%$ : $\pm 12\%$ Pitch range $\pm 16\%$ , $\pm 24\%$ : $\pm 26\%$ Pitch range $\pm 100\%$ : $\pm 99\%$
<b>Sampler</b>	
<b>Sampling:</b>	44.1 kHz
<b>Length:</b>	15 sec.
<b>Output level:</b>	2.0 V r.m.s. (Variable / -14 ~ +6 dB)
<b>Variable pitch:</b>	$\pm 24\%$ (0.1% pitch)
<b>Search precision:</b>	1/75 sec. (1 subcode frame)
<b>Max. scan speed:</b>	Over 20 times normal speed
<b>Max. MEMO memory steps:</b>	5000 steps

\* Specifications and design are subject to change without notice for purpose of improvement.

## **DENON, Ltd.**

16-11, YUSHIMA 3-CHOME, BUNKYOU-KU, TOKYO 113-0034, JAPAN  
Telephone: (03) 3837-5321