

FEATURES

- Fully qualified to Class H or K
- Radiation hardened
- -55° to +125°C operation
- 16 to 40 VDC input
- Fully Isolated
- Red hard optocoupler feedback
- Fixed frequency, 550 kHz typical
- Topology – Single Ended Forward
- Transient protection 50 V/120 ms
- Inhibit function
- Sync function
- Indefinite short circuit protection
- Undervoltage lockout
- Up to 84% efficiency

DC/DC CONVERTERS 28 VOLT INPUT

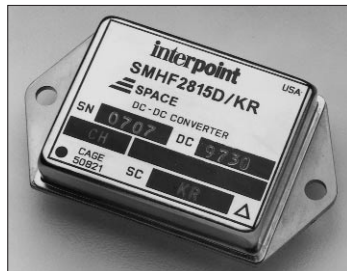

Size (max.): Non flanged 1.460 x 1.130 x 0.330 (37.08 x 28.70 x 8.38 mm)
 Flanged 2.005 x 1.130 x 0.330 (50.93 x 28.70 x 8.38 mm)
 See Figures 21 through 24 for dimensions.
 Weight: 30 grams maximum.
 Screening: Standard, Class H, or Class K (MIL-PRF-38534)
 Radiation hardness levels O, L, and R

SMHF SERIES SINGLE AND DUAL 15 WATT

MODELS	
VDC OUTPUT	
SINGLE	DUAL
3.3	±5
5	±12
12	±15
15	

DESCRIPTION

The SMHF Series™ of 28 V DC/DC converters offers a wide input voltage range of 16 to 40 volts and up to 15 watts of output power. The units are capable of withstanding short term transients up to 50 volts. The package is a hermetically sealed, seam-welded metal case. Flanged and non-flanged models are available.

SCREENING AND REPORTS

SMHF converters offer three screening options (Standard, Class H, or Class K) and three levels of radiation hardness (O, L, and R). See Tables 1, 2, and 3 for more information. Detailed reports on product performance are also available and are listed in Table 4.

CONVERTER DESIGN

The SMHF converters are switching regulators that use a quasi-square wave, single-ended forward converter design with a constant switching frequency of 550 kHz. Isolation between input and output circuits is provided with a transformer in the forward path and a temperature compensated opto-coupler in the feedback control loop. The opto-coupler is radiation hardened and is especially selected for space applications.

For the SMHF dual output models, cross regulation is maintained by tightly coupled output magnetics. Up to 70% of the total output power is available from either output, providing the opposite output is simultaneously carrying 30% of the total output power. Predictable current limit is accomplished by directly monitoring the output load current and providing a constant current output above the overload point.

HIGHER POWER DENSITY

The SMHF Series offers a new standard of performance for small size and high power density. At just 0.33 inch high and a total footprint of 1.7 in², this low profile package offers a total power density of up to 30 watts per cubic inch.

LOW NOISE, HIGH AUDIO REJECTION

The SMHF converters' feed-forward compensation system provides excellent dynamic response and noise rejection. Audio rejection is typically 50 dB. Typical output voltage response for a 50% to 100%

step load transient is as low as 1.3% with a 150 msec recovery time. Input ripple current is typically 35 mA p-p with output ripple voltage typically 30 mV p-p.

INHIBIT FUNCTION

SMHF converters provide an inhibit terminal that can be used to disable internal switching, resulting in no output and very low quiescent input current. The converter is inhibited when a TTL compatible low (<0.8 – output disabled) is applied to the inhibit pin. The unit is enabled when the pin, which is internally connected to a pull-up resistor, is left unconnected or is connected to an open-collector gate. The open circuit output voltage associated with the inhibit pin is 8.5 to 12 VDC. In the inhibit mode, a maximum of 12 mA must be sunk from the inhibit pin at 28 VDC input.

SYNCHRONIZATION

A synchronization feature is included with the SMHF Series that allows the user to match the switching frequency of the converter to the frequency of the system clock. An external synchronization feature is included that allows the user to adjust the nominally 550kHz operating frequency to any frequency within the range of 500 kHz to 600 kHz. This is initiated by applying a TTL compatible input of the desired frequency to pin 5.

SHORT CIRCUIT PROTECTION

SMHF Series converters provide short circuit protection by restricting the output current to approximately 115% of the full load output current. The output current is sensed in the secondary stage to provide highly predictable and accurate current limiting, and to eliminate foldback characteristics.

UNDERVOLTAGE LOCKOUT

Undervoltage lockout prevents the units from operating below approximately 14 VDC input voltage to keep system current levels smooth, especially during initialization or re-start operations.

SMHF SERIES DC/DC CONVERTERS

SINGLE AND DUAL

15 WATT

ABSOLUTE MAXIMUM RATINGS

- Input Voltage**
- 16 to 40 VDC
- Power Dissipation (Pd)**
- 8 W
- Output Power**
- 12 to 15 watts depending on model
- Lead Soldering Temperature (10 sec per lead)**
- 300°C
- Storage Temperature Range (Case)**
- -65°C to +150°C

RECOMMENDED OPERATING CONDITIONS

- Input Voltage Range**
- 16 to 40 VDC continuous
 - 0 V for up to 50 msec transient
- Case Operating Temperature (Tc)**
- -55°C to +125°C full power
 - -55°C to +135°C absolute
- Derating Output Power/Current (Tc)**
- Linearly from 100% at 125°C to 0% at 135°C

SYNC AND INHIBIT

- Sync In (500 to 600 kHz)**
- Duty cycle 40% to 60%
 - Logic low 0.8 V max
 - Logic high 4.5 V min, 5 V max
 - Referenced to input common
 - If not used, connect to input common
- Inhibit TTL Open Collector**
- Logic low (output disabled)
Logic low voltage ≤ 0.8 V max
Inhibit pin current 4.0 mA max
 - Referenced to input common
 - Logic high (output enabled)
Open collector or unconnected

TYPICAL CHARACTERISTICS

- Output Voltage Temperature Coefficient**
- 100 ppm/°C typical
 - 150 ppm/°C maximum
- Input to Output Capacitance**
- 60 pF typical
- Undervoltage Lockout**
- 12 V input typical
- Current Limit**
- 115% of full load typical
- Isolation**
- 100 megohm minimum at 500 V
- Audio Rejection**
- 50 dB typical
- Conversion Frequency (°55°C to +125°C Tc)**
- Free run 550 kHz typical
480 kHz min, 620 kHz max
- Inhibit Pin Voltage (unit enabled)**
- 8.5 to 12 V

Electrical Characteristics: 25°C Tc, 28 VDC Vin, 100% load, radiation level O, unless otherwise specified.

SINGLE OUTPUT MODELS		SMHF283R3S			SMHF2805S			SMHF2812S			SMHF2815S						
		Tc = 25°C			3.27	3.3	3.33	4.95	5	5.05	11.88	12	12.12	14.85	15	15.15	VDC
OUTPUT VOLTAGE	V _{IN} = 16 TO 40 VDC	—	—	2.4	—	—	2.4	—	—	1.25	—	—	1.00	—	—	—	A
OUTPUT POWER	V _{IN} = 16 TO 40 VDC	0	—	8	0	—	12	0	—	15	0	—	15	0	—	15	W
OUTPUT RIPPLE VOLTAGE	10 kHz - 2 MHz Tc = -55°C TO +125°C	—	60	160	—	30	80	—	60	160	—	60	75	—	100	260	mV p-p
LINE REGULATION	V _{IN} = 16 TO 40 VDC	—	5	100	—	5	100	—	5	100	—	5	100	—	5	100	mV
LOAD REGULATION	NO LOAD TO FULL	—	20	50	—	20	50	—	20	50	—	20	50	—	20	50	mV
INPUT VOLTAGE	CONTINUOUS	16	28	40	16	28	40	16	28	40	16	28	40	16	28	40	VDC
NO LOAD TO FULL	TRANSIENT 120 ms	0	—	50	0	—	50	0	—	50	0	—	50	0	—	50	V
INPUT CURRENT	NO LOAD	—	25	65	—	25	40	—	25	50	—	25	62	—	25	62	mA
	FULL LOAD	—	—	397	—	—	560 624	—	—	680 752	—	—	670 752	—	—	670 752	
	INHIBITED	—	5	12	—	5	12	—	5	12	—	5	12	—	5	12	
INPUT RIPPLE CURRENT	10k Hz - 10 MHz Tc = -55°C TO +125°C	—	45	80	—	35	80	—	35	80	—	35	80	—	35	80	mV p-p
EFFICIENCY	Tc = 25°C	70	73	—	73	75	—	78	79	—	74	80	—	—	—	—	%
LOAD FAULT ¹	SHORT CIRCUIT	—	5	8	—	3.5	8	—	3.5	8	—	3.5	7	—	3.5	7	W
	POWER DISSIPATION	—	7.5	30	—	7.5	30	—	7.5	30	—	7.5	30	—	7.5	30	ms
STEP LOAD RESPONSE	50 %-100%- 50% TRANSIENT	-400	150	500	-500	150	500	-700	150	700	-800	200	800	—	—	—	mV pk
	RECOVERY ²	—	150	300	—	150	300	—	150	500	—	600	1200	—	—	—	µs
STEP LINE RESPONSE	16 TO 40 TO 16 V _{IN} TRANSIENT ³	-800	550	800	-800	550	800	-800	550	800	-800	550	800	—	—	—	mV pk
	RECOVERY ²	—	0.8	1.2	—	0.8	1.2	—	0.8	1.2	—	0.8	1.2	—	0.8	1.2	µs
START-UP	DELAY	—	10	25	—	10	25	—	10	25	—	10	25	—	10	25	µs
0 TO 28 VIN	OVERSHOOT ⁴	—	200	300	—	100	600	—	200	1200	—	200	1500	—	—	—	mV pk

Notes

1. Indefinite short circuit protection not guaranteed above 125°C (case)
2. Recovery time is measured from application of the transient to the point at which Vout is within regulation.
3. Input step transition time >10µs.
4. Input step transition time <100µs.

DC/DC CONVERTERS

SMHF SERIES SINGLE AND DUAL 15 WATT

Electrical Characteristics: 25°C Tc, 28 VDC Vin, 100% load, radiation level O, unless otherwise specified.

DUAL OUTPUT MODELS		SMHF2805D			SMHF2812D			SMHF2815D			UNITS
PARAMETER	CONDITIONS	MIN	TYP	MAX	MIN	TYP	MAX	MIN	TYP	MAX	
OUTPUT VOLTAGE	+V _{OUT}	4.95	5.00	5.05	11.88	12.00	12.12	14.85	15.00	15.15	VDC
	-V _{OUT}	4.92	5.00	5.08	11.82	12.00	1218	14.78	15.00	15.23	
OUTPUT CURRENT ¹	V _{IN} = 16 to 40 VDC	—	±1.2	1.68	—	±0.625	0.875	—	±0.500	0.700	A
OUTPUT POWER ¹	V _{IN} = 16 to 40 VDC	—	—	12	—	—	15	—	—	15	W
OUTPUT RIPPLE VOLTAGE ±V _{OUT}	10 kHz - 2 MHz	—	60	160	—	70	175	—	70	175	mV p-p
	Tc = -55°C to +125°C	—	100	240	—	100	275	—	100	275	
LINE REGULATION Vin = 16 to 40 VDC	BALANCED +V _{OUT}	—	5	50	—	5	50	—	5	50	mV
	LOAD -V _{OUT}	—	—	100	—	—	100	—	—	100	
LOAD REGULATION	BALANCED +V _{OUT}	—	20	50	—	20	50	—	20	50	mV
	LOAD -V _{OUT}	—	—	150	—	—	150	—	—	150	
CROSS REGULATION ²	NEGATIVE V _{OUT}	—	6	7.5	—	3	6	—	3	6	%
INPUT VOLTAGE	CONTINUOUS	16	28	40	16	28	40	16	28	40	VDC
NO LOAD TO FULL	TRANSIENT 50 msec	—	—	50	—	—	50	—	—	50	V
INPUT CURRENT	NO LOAD	—	20	50	—	25	50	—	25	50	mA
	FULL LOAD	—	540	600	—	645	754	—	638	754	
	INHIBITED	—	6	12	—	5	12	—	5	12	
INPUT RIPPLE CURRENT	10 kHz - 10 MHz	—	30	80	—	40	80	—	40	80	mA p-p
	Tc = -55°C to +125°C	—	60	120	—	55	120	—	55	120	
EFFICIENCY		75	77	—	74	81	—	74	82	—	%
LOAD FAULT	SHORT CIRCUIT ³	—	—	—	—	—	—	—	—	—	W
	POWER DISSIPATION	—	3	8	—	3	6	—	3	6	
	RECOVERY ⁴	—	7.5	30	—	7.5	50	—	7.5	50	ms
STEP LOAD RESP. ⁵ BALANCED LOADS	50% - 100% - 50%	—	—	—	—	—	—	—	—	—	mV pk
	TRANSIENT +V _{OUT}	-600	200	600	-600	300	600	-600	300	600	
	-V _{OUT}	-600	150	600	-600	100	500	-600	100	600	
	RECOVERY ⁴	—	150	500	—	200	500	—	200	600	µs
STEP LINE RESP. ± V _{OUT}	16 - 40 - 40 VDC	—	—	—	—	—	—	—	—	—	mV pk
	TRANSIENT ⁶	-800	600	800	-750	550	750	-750	550	750	
	RECOVERY ⁴	—	0.8	1.2	—	0.8	1.2	—	0.8	1.2	ms
START-UP	DELAY	—	12	30	—	12	25	—	12	25	ms
	OVERSHOOT ⁷	0	100	500	0	200	500	0	200	500	mV pk

Notes

- Up to 70% of the total output power is available from either output providing the opposite output is simultaneously carrying 30% of the total output power. Each output must carry a minimum of 30% of the total output power in order to maintain regulation on the negative outputs.
- Effect on -V_{OUT} for the following conditions, percentages are of total power:
+Po = 50% to 10% and -Po = 50%
+Po = 50% and -Po = 50% to 10%
- Indefinite short circuit protection not guaranteed above 125°C (case)
- Recovery time is measured from application of the transient to point at which V_{out} is within regulation.
- Response of either output with the opposite output held at half of the total output power.
- Input step transition time >10µs.
- Input step transition time <100µs.

**SMHF SERIES
SINGLE AND DUAL
15 WATT**

DC/DC CONVERTERS

BLOCK DIAGRAM

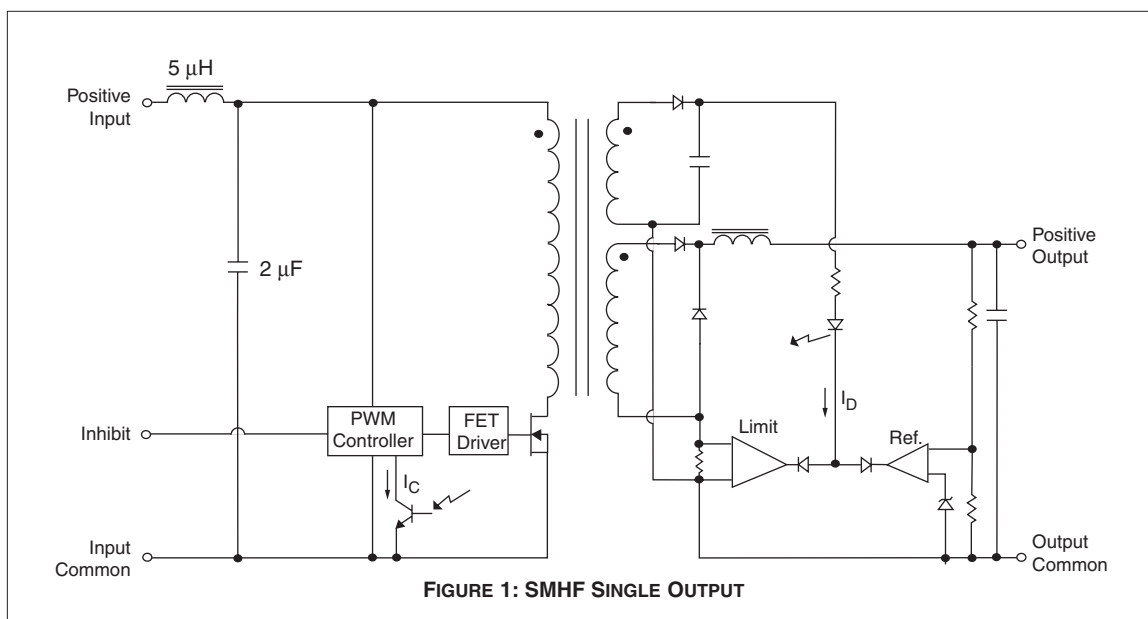

DC/DC CONVERTERS

SMHF SERIES SINGLE AND DUAL 15 WATT

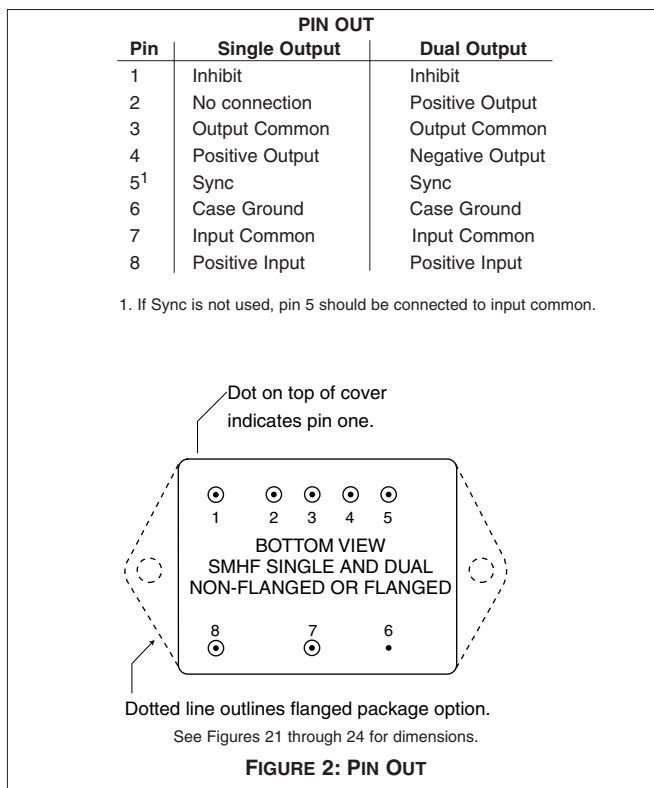

SMD NUMBERS	
STANDARD MICROCIRCUIT DRAWING (SMD)	SMHF SIMILAR PART
5962-9213902HXC	SMHF2805S/HO
IN PROCESS	SMHF2812S/HO
5962-9160102HXC	SMHF2815S/HO
5962-9555902HXC	SMHF2805D/HO
5962-9214402HXC	SMHF2812D/HO
5962-9161402HXC	SMHF2815D/HP

To indicate the flanged case option change the "X" to "Z" in the SMD number. The SMD number shown is for Class H screening, non-flanged, and no Radiation Hardness Assurance (RHA) level. See the SMD for the numbers for other screening and radiation levels. For exact specifications for an SMD product, refer to the SMD drawing. Call your Interpoint representative for status on the SMHF SMD releases which are "in process." SMDs can be downloaded from <http://www.dscc.dla.mil/programs/smc>

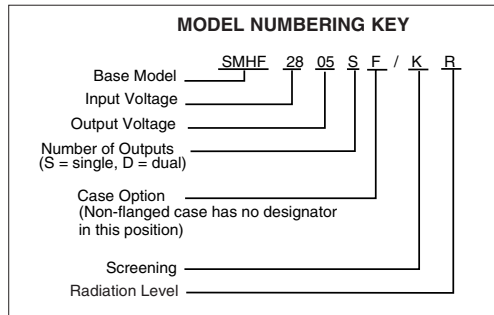

SMHF SERIES SINGLE AND DUAL 15 WATT

DC/DC CONVERTERS

Typical Performance Curves: 25°C Tc , 28 VDC Vin, 100% load, free run, unless otherwise specified.

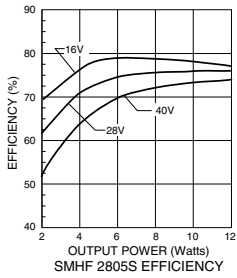

FIGURE 3

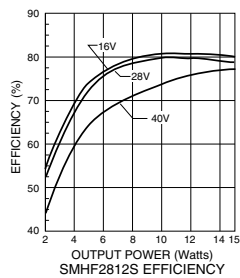

FIGURE 4

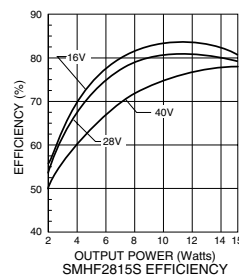

FIGURE 5

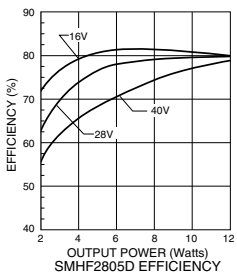

FIGURE 6

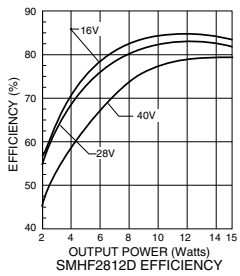

FIGURE 7

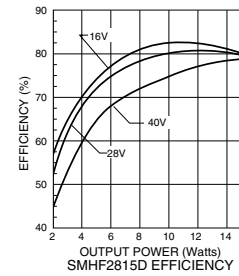

FIGURE 8

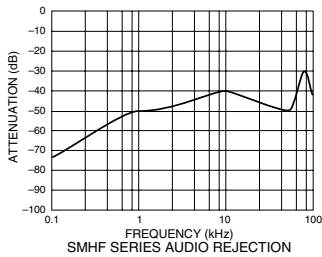

FIGURE 9

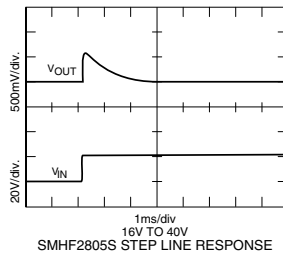

FIGURE 10

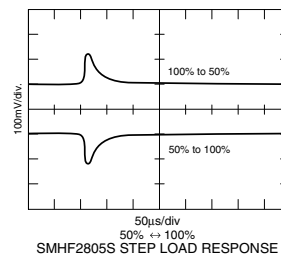
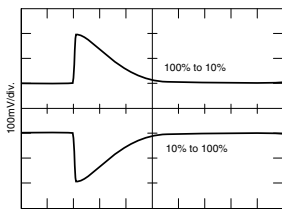

FIGURE 11

DC/DC CONVERTERS

SMHF SERIES SINGLE AND DUAL 15 WATT

Typical Performance Curves: 25°C Tc , 28 VDC Vin, 100% load, free run, unless otherwise specified.



SMHF2805S STEP LOAD RESPONSE

FIGURE 12

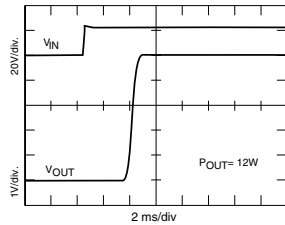

SMHF2805S TURN-ON INTO FULL LOAD

FIGURE 13

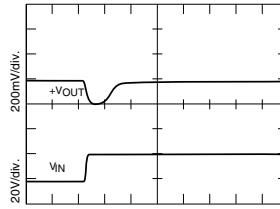

SMHF2815D STEP LINE RESPONSE

FIGURE 14

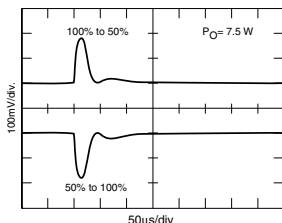

SMHF2815D STEP LOAD RESPONSE

FIGURE 15

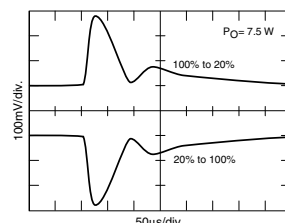

SMHF+2815D VOUT STEP LOAD RESPONSE

FIGURE 16

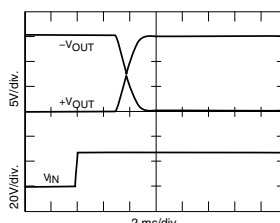

SMHF2815D TURN-ON INTO FULL LOAD

FIGURE 17

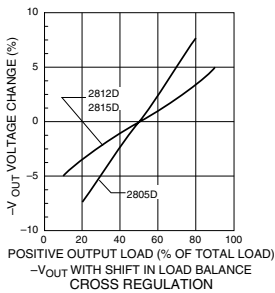
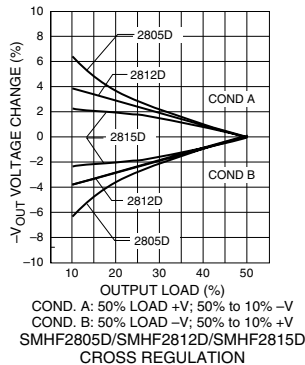

FIGURE 18



COND. A: 50% LOAD +V; 50% to 10% -V
COND. B: 50% LOAD -V; 50% to 10% +V
SMHF2805D/SMHF2812D/SMHF2815D
CROSS REGULATION

FIGURE 19

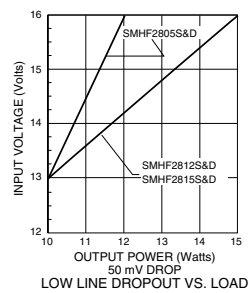
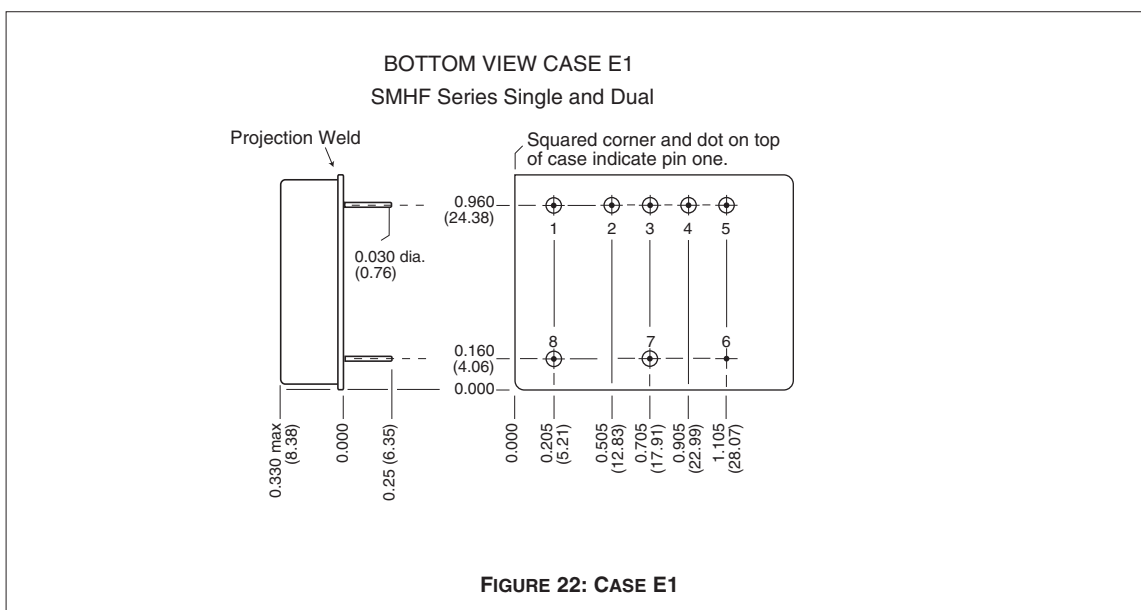
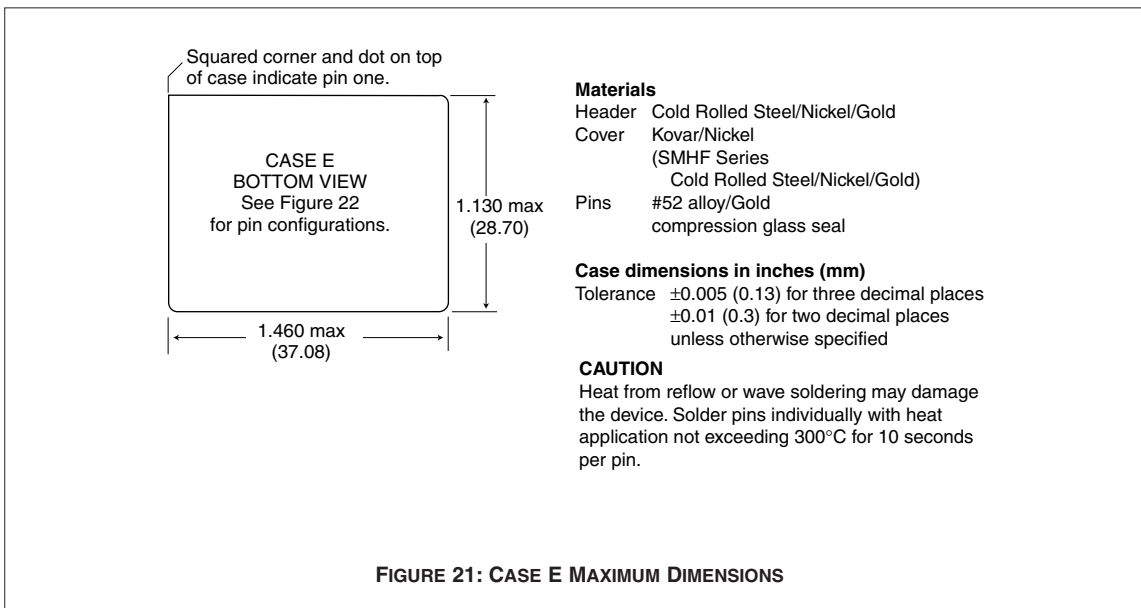

FIGURE 20

**SMHF SERIES
SINGLE AND DUAL
15 WATT**

DC/DC CONVERTERS



Note: Although every effort has been made to render the case drawings at actual size, variations in the printing process may cause some distortion. Please refer to the numerical dimensions for accuracy.

DC/DC CONVERTERS

SMHF SERIES SINGLE AND DUAL 15 WATT

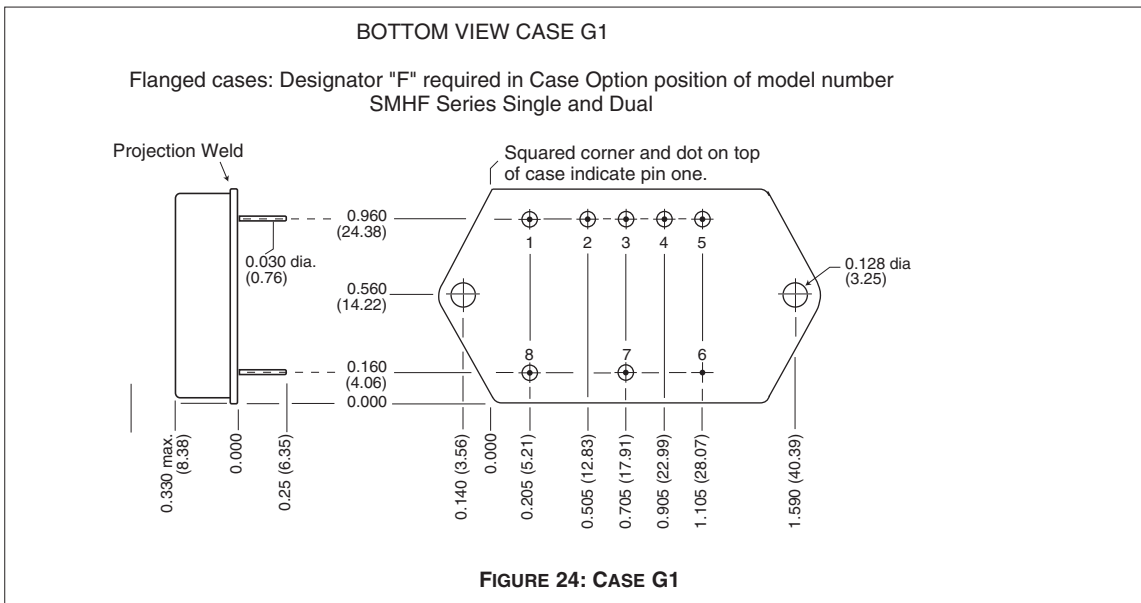
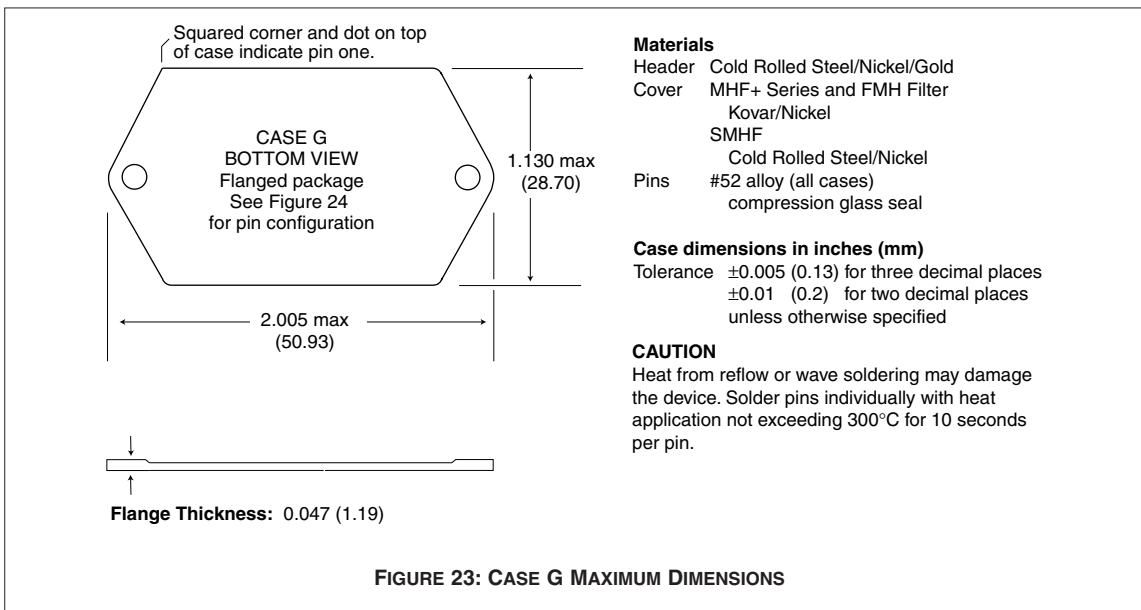

**SMHF SERIES
SINGLE AND DUAL
15 WATT**

DC/DC CONVERTERS

TABLE 1: ELEMENT EVALUATION

ELEMENT EVALUATION TEST PERFORMED (COMPONENT LEVEL)	SPACE PROTOTYPE (O)		CLASS H		CLASS K	
	M/S	P	M/S	P	M/S	P
	Element Electrical	yes	no	yes	yes	yes
Element Visual	no	no	yes	yes	yes	yes
Internal Visual	no	no	yes	no	yes	no
Temperature Cycling	no	no	no	no	yes	yes
Constant Acceleration	no	no	no	no	yes	yes
Interim Electrical	no	no	no	no	yes	no
Burn-in	no	no	no	no	yes	no
Post Burn-in Electrical	no	no	no	no	yes	no
Steady State Life	no	no	no	no	yes	no
Voltage Conditioning /Aging	no	no	no	no	no	yes
Visual Inspection	no	no	no	no	no	yes
Final Electrical	no	no	yes	yes	yes	yes
Wire Bond Evaluation	no	no	yes	yes	yes	yes
SEM	no	no	no	no	yes	no
SLAM™/C-SAM: Input capacitors only (Add'l test, not req. by H or K)	no	no	no	yes	no	yes

Notes

- M/S Active components (Microcircuit and Semiconductor Die)
- P Passive components

Definitions

Element Evaluation: Component testing/screening per MIL-STD-883 as determined by MIL-PRF-38534

SEM: Scanning Electron Microscopy

SLAM™: Scanning Laser Acoustic Microscopy

C-SAM: C - Mode Scanning Acoustic Microscopy

DC/DC CONVERTERS

SMHF SERIES SINGLE AND DUAL 15 WATT

TABLE 2: PRODUCT ENVIRONMENTAL SCREENING

ENVIRONMENTAL SCREENING TEST PERFORMED (END ITEM LEVEL)	SPACE PROTOTYPE (O)	CLASS H	CLASS K
Non-destruct bond pull Method 2023	no	no	yes
Pre-cap inspection Method 2017, 2032	yes	yes	yes
Temperature cycle Method 1010, Cond. C	yes	yes	yes
Constant acceleration Method 2001, 3000 g	yes	yes	yes
PIND Test Method 2020, Cond. B	no	yes	yes
Radiography Method 2012	no	no	yes
Pre burn-in test	yes	yes	yes
Burn-in, Method 1015, 125°C			
96 hours	yes	no	no
160 hours	no	yes	no
2 x 160 hour (includes mid BI test)	no	no	yes
Final electrical test MIL-PRF-38534, Group A	yes	yes	yes
Hermeticity test			
Fine Leak, Method 1014, Cond. A	yes	yes	yes
Gross Leak, Method 1014, Cond. C	yes	yes	yes
Final visual inspection Method 2009	yes	yes	yes

Test methods are referenced to MIL-STD-883 as determined by MIL-PRF-38534.

**SMHF SERIES
SINGLE AND DUAL
15 WATT**

DC/DC CONVERTERS

TABLE 3: RADIATION HARDNESS LEVELS

PRODUCT LEVEL AVAILABILITY	ENVIRONMENTAL SCREENING LEVELS		
	SPACE PROTOTYPE (O)	CLASS H	CLASS K
RADIATION HARDNESS LEVELS O: Standard, no radiation guarantee For system evaluation, electrically and mechanically comparable to H and K level.	OO	HO	Not available
R: Radiation hardened – Tested lots Up to 100 k Rads (Si) total dose SEU guarantee up to 40 MeV	Not available	HR	KR

R is referenced to MIL-PRF-38534, appendix G, Radiation Hardness Assurance (RHA) levels.

TABLE 4: REPORTS INCLUDED WITH PURCHASE OF PRODUCT HR or KR
<ol style="list-style-type: none"> 1. Radiation Susceptibility Analysis 2. Electrical/Thermal Stress Analysis and Derating Report 3. MTBF Report 4. FMEA Report <p>HO option: Reports 2, 3, and 4 are included with purchase. OO option: Select reports available as separate purchases.</p>

Contact Information:

www.interpoint.com

Interpoint Headquarters USA
Phone: 1-800-822-8782
+425-882-3100
Email: power@intp.com

Interpoint UK
Phone: +44-1252-872266
Email: poweruk@intp.com

Interpoint France
Phone: +33-134285455
Email: powerfr@intp.com

11921-001-DTS Rev B This revision supercedes all previous releases.
All technical information is believed to be accurate, but no responsibility is assumed for errors or omissions. Interpoint reserves the right to make changes in products or specifications without notice. SMHF Series is a trademark of Interpoint. Copyright © 1997-2000 Interpoint. All rights reserved.

