





Features

- Radial Leaded Devices
- Fast tripping resettable PTCs
- Binned and sorted narrow resistance ranges available
- RoHS compliant*
- Lead free
- Agency recognition:   

Applications

- Customer Premise Equipment (CPE)
- Central Office / Telecom Centers (CO)
- Access equipment

MF-RX/250 Series - Telecom PTC Resettable Fuses

Electrical Characteristics

Model	Max. Operating Voltage (Vdc)	Max. Interrupt Ratings		Hold Current Amps at 23 °C	Initial Resistance		One Hour Post-Trip Resistance Ohms at 23 °C
		Volts (Vrms)	Amps (A)		Ohms at 23 °C	Ohms at 23 °C	
		Max.	Max.	I _H	Min.	Max.	Max.
MF-RX012/250	60	250	3.0	0.12	4.0	8.0	16.0
MF-RX012/250-A	60	250	3.0	0.12	7.0	9.0	16.0
MF-RX012/250-C	60	250	3.0	0.12	5.5	7.5	14.0
MF-RX012/250-F	60	250	3.0	0.12	6.0	10.5	16.0
MF-RX012/250-1	60	250	3.0	0.12	6.0	9.0	16.0
MF-RX012/250-2	60	250	3.0	0.12	8.0	10.5	16.0
MF-RX012/250-T	60	250	3.0	0.12	7.0	12.0	16.0
MF-RX012/250U	60	250	3.0	0.12	6.0	10.0	16.0
MF-RX014/250	60	250	3.0	0.145	3.0	6.0	14.0
MF-RX014/250-A	60	250	3.0	0.145	3.0	5.5	12.0
MF-RX014/250-B	60	250	3.0	0.145	4.5	6.0	14.0
MF-RX014/250-T	60	250	3.0	0.145	5.4	7.5	14.0
MF-RX014/250U	60	250	3.0	0.145	3.5	6.5	12.0
MF-RX018/250	60	250	10.0	0.18	0.8	2.0	4.0
MF-RX018/250F	100	250	10.0	0.18	0.8	2.2	4.0
MF-RX018/250U	60	250	10.0	0.18	0.8	2.0	4.0

*"U" suffix indicates product without insulation coating.

Environmental Characteristics

Operating/Storage Temperature-40 °C to +85 °C
Maximum Device Surface Temperature	
in Tripped State125 °C
Passive Aging+85 °C, 1000 hours±15 % typical resistance change
+60 °C, 1000 hours±15 % typical resistance change
Humidity Aging+85 °C, 85 % R.H. 500 hours±15 % typical resistance change
Thermal ShockMIL-STD-202F, Method 107G,±10 % typical resistance change
+125 °C to -55 °C, 10 times±15 % typical resistance change
Solvent ResistanceMIL-STD-202, Method 215B.....No change
Lead SolderabilityANSI/J-STD-002>95 % coverage
FlammabilityIEC 695-2-2.....No Flame for 60 secs.
VibrationMIL-STD-883C, Method 2007.1, Condition A.....±5 % typical resistance change

Test Procedures And Requirements For Model MF-RX/250 Series

Test	Test Conditions	Accept/Reject Criteria
Visual/Mech.Verify dimensions and materials.....Per MF physical description
ResistanceIn still air @ 23 °CR _{min} ≤ R ≤ R _{1max}
Time to TripAt specified current, V _{max} , 23 °CT ≤ typical time to trip (seconds)
Hold Current30 min. at I _{hold}No trip
Trip Cycle LifeV _{max} , I _{max} , 100 cyclesNo arcing or burning
Trip EnduranceV _{max} , 48 hoursNo arcing or burning
UL File NumberE 174545S	
CSA File NumberCA 110338	
TÜV File NumberR02057213	

*RoHS Directive 2002/95/EC Jan 27 2003 including Annex
 Specifications are subject to change without notice.
 Customers should verify actual device performance in their specific applications.

Additional Features

- Ability to withstand AC power cross conditions
- Assists equipment with meeting ITU-T K.20/K.21/K.45
- Assists equipment with meeting Telcordia GR-1089-C Intrabuilding

MF-RX/250 Series - Telecom PTC Resettable Fuses

BOURNS®

Thermal Derating Chart - I_{hold} (Amps)

Model	Ambient Operating Temperature								
	-40 °C	-20°C	0 °C	23 °C	40 °C	50 °C	60 °C	70 °C	85 °C
MF-RX012/250	0.186	0.165	0.143	0.120	0.099	0.088	0.077	0.066	0.050
MF-RX014/250	0.225	0.199	0.172	0.145	0.119	0.106	0.093	0.080	0.060
MF-RX018/250	0.269	0.240	0.211	0.180	0.153	0.138	0.123	0.109	0.087
MF-RX018/250F	0.279	0.247	0.213	0.180	0.147	0.131	0.115	0.099	0.074

I_{trip} is approximately two times I_{hold} .

Product Dimensions

Model	A Max.	B Max.	C Nom.	D Min.	E Max.	Physical Characteristics		
						Lead Dia.	Style	Material
MF-RX012/250	6.5 (0.256)	11.0 (0.433)	5.1 ± 0.7 (0.201 ± 0.028)	4.7 (0.185)	4.6 (0.181)	0.65 (0.026)	1	Sn/Cu
MF-RX012/250U	6.0 (0.236)	10.0 (0.394)	5.1 ± 0.7 (0.201 ± 0.028)	4.7 (0.185)	3.8 (0.150)	0.65 (0.026)	1	Sn/Cu
MF-RX014/250	6.5 (0.256)	11.0 (0.433)	5.1 ± 0.7 (0.201 ± 0.028)	4.7 (0.185)	4.6 (0.181)	0.65 (0.026)	1	Sn/Cu
MF-RX014/250U	6.0 (0.236)	10.0 (0.394)	5.1 ± 0.7 (0.201 ± 0.028)	4.7 (0.185)	3.8 (0.150)	0.65 (0.026)	1	Sn/Cu
MF-RX018/250	11.0 (0.433)	13.6 (0.535)	5.1 ± 0.7 (0.201 ± 0.028)	4.7 (0.185)	4.6 (0.181)	0.65 (0.026)	1	Sn/Cu
MF-RX018/250U	10.4 (0.409)	12.6 (0.496)	5.1 ± 0.7 (0.201 ± 0.028)	4.7 (0.185)	3.8 (0.150)	0.65 (0.026)	1	Sn/Cu
MF-RX018/250F	9.0 (0.354)	12.5 (0.492)	5.1 ± 0.7 (0.201 ± 0.028)	4.7 (0.185)	3.8 (0.150)	0.65 (0.026)	2	Sn/Cu

Packaging options:
BULK: 500 pcs. per bag. TAPE & REEL: 1500 pcs. per reel (available binned).

DIMENSIONS = $\frac{MM}{(INCHES)}$

Style 1

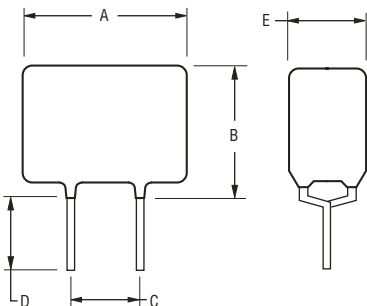

Style 2

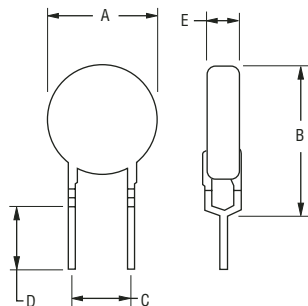

Typical Part Marking

Represents total content. Layout may vary.
MF-RX012/250 ~ MF-RX018/250:

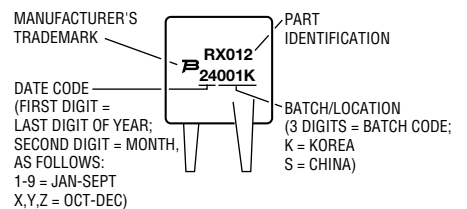

NOTE: UNCOATED PARTS HAVE NO PART MARKING.
MARKING IS ON LABEL ONLY.

MF-RX018/250F:

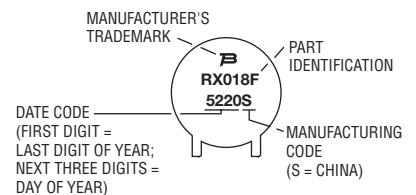

Specifications are subject to change without notice.
Customers should verify actual device performance in their specific applications.

MF-RX/250 Series - Telecom PTC Resettable Fuses



How to Order

MF - RX 012/250 U - A 5 - 2

- Multifuse® Product Designator
- Series: RX = Radial Leaded Component
- Hold Current, I_{hold}: 008-018 (0.08-0.18 Amps)
- Max. Interrupt Voltage, V: 250 (250 Volts)
- Telecom Options: F = Round Version (MF-RX018/250F only), U = Uncoated (radial parts only)
- Resistance Sorted: Narrow resistance ranges - see Resistance Options chart
- Resistance Bins of 0.5 ohms: 05 = 0.5 ohm binned parts (epoxy coated), 5 = 0.5 ohm binned parts (uncoated)
- Packaging Options: 0 = Bulk Packaging, 2 = Tape and Reel* (available with binned option)

*Packaged per EIA486-B

Typical Time to Trip at 23 °C

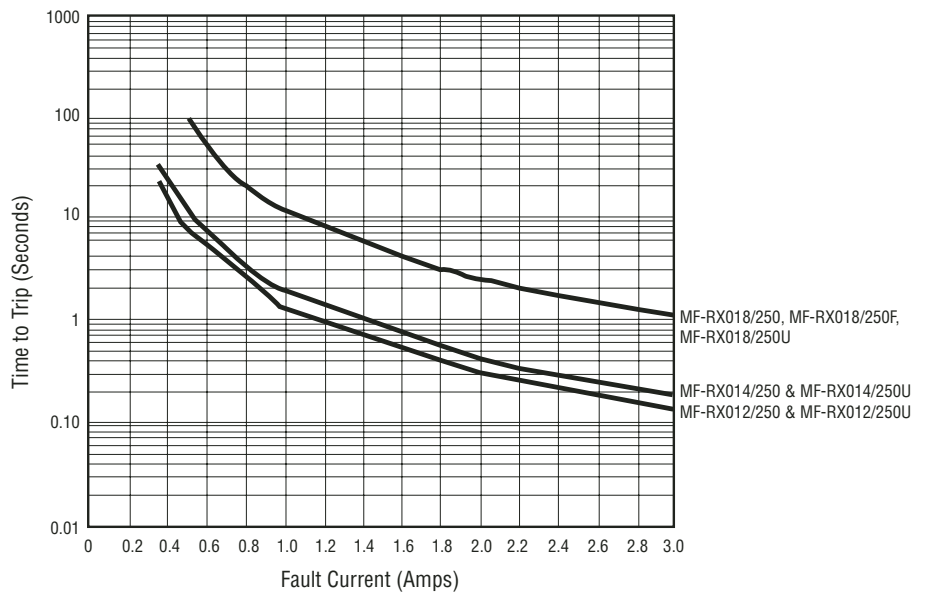

Resistance Options

Model	Initial Resistance Values		R1max	Bin
	Ohms @ 23 °C		Ohms @ 23 °C	
	Min.	Max.	Max.	
MF-RX012/250	4.0	8.0	16.0	0.5
MF-RX012/250-A05	7.0	9.0	16.0	0.5
MF-RX012/250-C05	5.5	7.5	14.0	0.5
MF-RX012/250-F05	6.0	10.5	16.0	0.5
MF-RX012/250-105	6.0	9.0	16.0	0.5
MF-RX012/250-205	8.0	10.5	16.0	0.5
MF-RX012/250-T05	7.0	12.0	16.0	0.5
MF-RX012/250U	6.0	10.0	16.0	0.5
MF-RX014/250	3.0	6.0	14.0	0.5
MF-RX014/250-A05	3.0	5.5	12.0	0.5
MF-RX014/250-B05	4.5	6.0	14.0	0.5
MF-RX014/250U	3.5	6.5	12.0	0.5
MF-RX018/250-F05	0.8	2.2	4.0	0.5

**MF-R, MF-R/72, MF-R/90, MF-R/600, MF-RX, MF-RX/72 & MF-RX/250 Series
Tape and Reel Specifications**

BOURNS®

Devices taped using EIA468-B/IEC286-2 standards. See table below and Figures 1 and 2 for details.

Dimension Description	IEC Mark	EIA Mark	Dimensions	
			Dimensions	Tolerance
Carrier tape width	W	W	$\frac{18}{(.709)}$	$\frac{-0.5/+1.0}{(-0.02/+0.039)}$
Hold down tape width:	W_0	W_4	$\frac{11}{(.433)}$	min.
Hold down tape			No protrusion	
Top distance between tape edges	W_2	W_6	$\frac{3}{(.118)}$	max.
Sprocket hole position	W_1	W_5	$\frac{9}{(.354)}$	$\frac{-0.5/+0.75}{(-0.02/+0.03)}$
Sprocket hole diameter	D_0	D_0	$\frac{4}{(.157)}$	$\frac{\pm 0.2}{(\pm .0078)}$
Abscissa to plane (straight lead)	H	H	$\frac{18.5}{(.728)}$	$\frac{\pm 3.0}{(\pm .118)}$
Abscissa to plane (kinked lead)	H_0	H_0	$\frac{16}{(.63)}$	$\frac{\pm 0.5}{(\pm .02)}$
Abscissa to top (straight lead)	H_1	H_1	$\frac{38.0}{(1.496)}$	max.
Abscissa to top (kinked lead)	H_1	H_1	$\frac{32.2}{(1.268)}$	max.
Overall width w/lead protrusion (straight lead)		C_1	$\frac{55.0}{(2.165)}$	max.
Overall width w/lead protrusion (kinked lead)		C_1	$\frac{43.2}{(1.7)}$	max.
Overall width w/o lead protrusion (straight lead)		C_2	$\frac{54.0}{(2.126)}$	max.
Overall width w/o lead protrusion (kinked lead)		C_2	$\frac{42.5}{(1.673)}$	max.
Lead protrusion	l_1	L_1	$\frac{1.0}{(.039)}$	max.
Protrusion of cutout	L	L	$\frac{11}{(.433)}$	max.
Protrusion beyond hold tape	l_2	l_2	Not specified	
Sprocket hole pitch	P_0	P_0	$\frac{12.7}{(0.5)}$	$\frac{\pm 0.3}{(\pm .012)}$
Pitch tolerance			20 consecutive	$\frac{\pm 1}{(\pm .039)}$
Device pitch: MF-R005–MF-R160, MF-R/90, MF-RX110/72–MF-RX185/72, MF-R/72			$\frac{12.7}{(0.5)}$	$\frac{\pm 0.3}{(\pm .012)}$
Device pitch: MF-R185–MF-R400, MF-RX110–MF-RX375 MF-R/600, MF-RX250/72–MF-RX375/72			$\frac{25.4}{(1.0)}$	$\frac{\pm 0.6}{(\pm .024)}$
Tape thickness	t	t	$\frac{0.9}{(.035)}$	max.
Tape thickness with splice: MF-R010–MF-R160, MF-R/72, MF-RX110/72–MF-RX185/72,		t_1	$\frac{1.5}{(.059)}$	max.
Tape thickness with splice: MF-R250–MF-R1100 MF-RX110–MF-RX375, MF-R/90, MF-RX250/72–MF-RX375/72		t_1	$\frac{2.3}{(.091)}$	max.
Splice sprocket hole alignment			0	$\frac{\pm 0.3}{(\pm .012)}$
Body lateral deviation	Δh	Δh	0	$\frac{\pm 1.0}{(\pm .039)}$
Body tape plane deviation	Δp	Δp	0	$\frac{\pm 1.3}{(\pm .051)}$
Lead spacing	F	F	$\frac{5.08}{(0.2)}$	$\frac{\pm 0.2}{(\pm .008)}$
Reel width	w	W_2	$\frac{56}{(2.205)}$	max.
Reel diameter	d	a	$\frac{370}{(14.57)}$	max.
Space between flanges less device	W_1	h	$\frac{4.75}{(.187)}$	$\frac{\pm 3.25}{(\pm .128)}$

Specifications are subject to change without notice.
Customers should verify actual device performance in their specific applications.

DIMENSIONS = $\frac{\text{MM}}{\text{(INCHES)}}$

**MF-R, MF-R/72, MF-R/90, MF-R/600, MF-RX, MF-RX/72 & MF-RX/250 Series
Tape and Reel Specifications**



Dimension Description	IEC Mark	EIA Mark	Dimensions	
			Dimensions	Tolerance
Arbor hole diameter	<i>f</i>	<i>c</i>	$\frac{26}{(1.024)}$	$\frac{\pm 12.0}{(\pm .472)}$
Core diameter: MF-R, MF-RX, MF-R/90	<i>h</i>	<i>n</i>	$\frac{80}{(3.15)}$	max.
Core diameter: MF-RX/250, MF-R/600	<i>h</i>	<i>n</i>	$\frac{91}{(3.58)}$	max.
Box: MF-R, MF-RX, MF-R/90			$\frac{56}{(2.2)}$ $\frac{372}{(14.6)}$ $\frac{372}{(14.6)}$	max.
Box: MF-RX/250			$\frac{67}{(2.64)}$ $\frac{372}{(14.6)}$ $\frac{362}{(14.25)}$	max.
Box: MF-R/600			$\frac{64}{(2.52)}$ $\frac{372}{(14.6)}$ $\frac{362}{(14.25)}$	max.
Consecutive missing places: MF-R, MF-RX, MF-R/90			3	max.
Consecutive missing places: MF-RX/250, MF-R/600			none	
Empty places per reel: MF-R, MF-RX, MF-R/90			Not specified	
Empty places per reel: MF-RX/250, MF-R/600			0.1 %	

Taped Component Dimensions - Figure 1

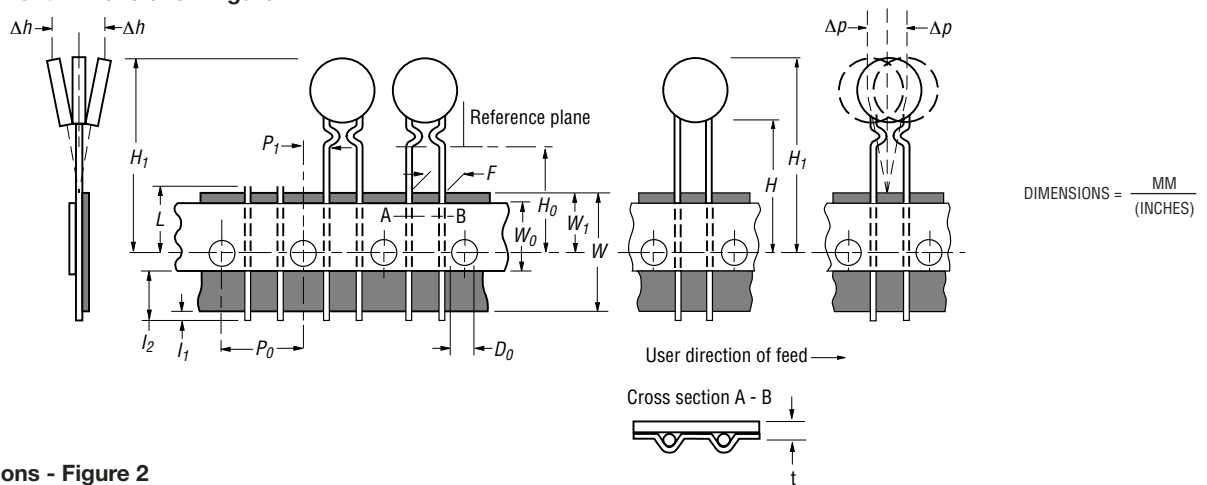

Reel Dimensions - Figure 2

