

NEC**TFT COLOR LCD MODULE
NL10276BC28-05D****36 cm (14.1 inches), 1024 × 768 pixels, 262,144 colors,
LVDS interface, high luminance****DESCRIPTION**

The NL10276BC28-05D is a TFT (thin film transistor) active-matrix color liquid crystal display (LCD) module comprising an amorphous silicon TFT attached to each signal electrode, a driving circuit, and a backlight. The NL10276BC28-05D has a built-in backlight and no inverters.

The 36 cm (14.1 inch) diagonal display area contains 1024 × 768 pixels and can display 262,144 colors simultaneously.

FEATURES

- High luminance
- Low reflection
- LVDS interface (equivalent to the THC63LVDF64A of Thine Electronics, Inc.)
- 6-bit digital RGB signals
- Incorporated edge-type backlight (two lamps) and lamp holder are replaceable

APPLICATIONS

- PC monitors



The information in this document is subject to change without notice.

Please confirm the delivery specification before starting to design your system.

www.DataSheet4U.com

STRUCTURE AND FUNCTION

A color TFT (thin film transistor) LCD module is comprised of a TFT liquid crystal panel structure, LSIs for driving the TFT array, and a backlight assembly. The TFT panel structure is created by sandwiching liquid crystal material in the narrow gap between a TFT array glass substrate and a color filter glass substrate. After the driver LSIs are connected to the panel, the backlight assembly is attached to the back side of the panel.

RGB (red, green, blue) data signals from a source system are modulated into a form suitable for active-matrix addressing by the onboard signal processor and sent to the driver LSIs, which in turn address the individual TFT cells.

Acting as an electro-optical switch, each TFT cell regulates light transmission from the backlight assembly when activated by the data source. By regulating the amount of light passing through the array of red, green, and blue dots, color images are created with clarity.

BLOCK DIAGRAM

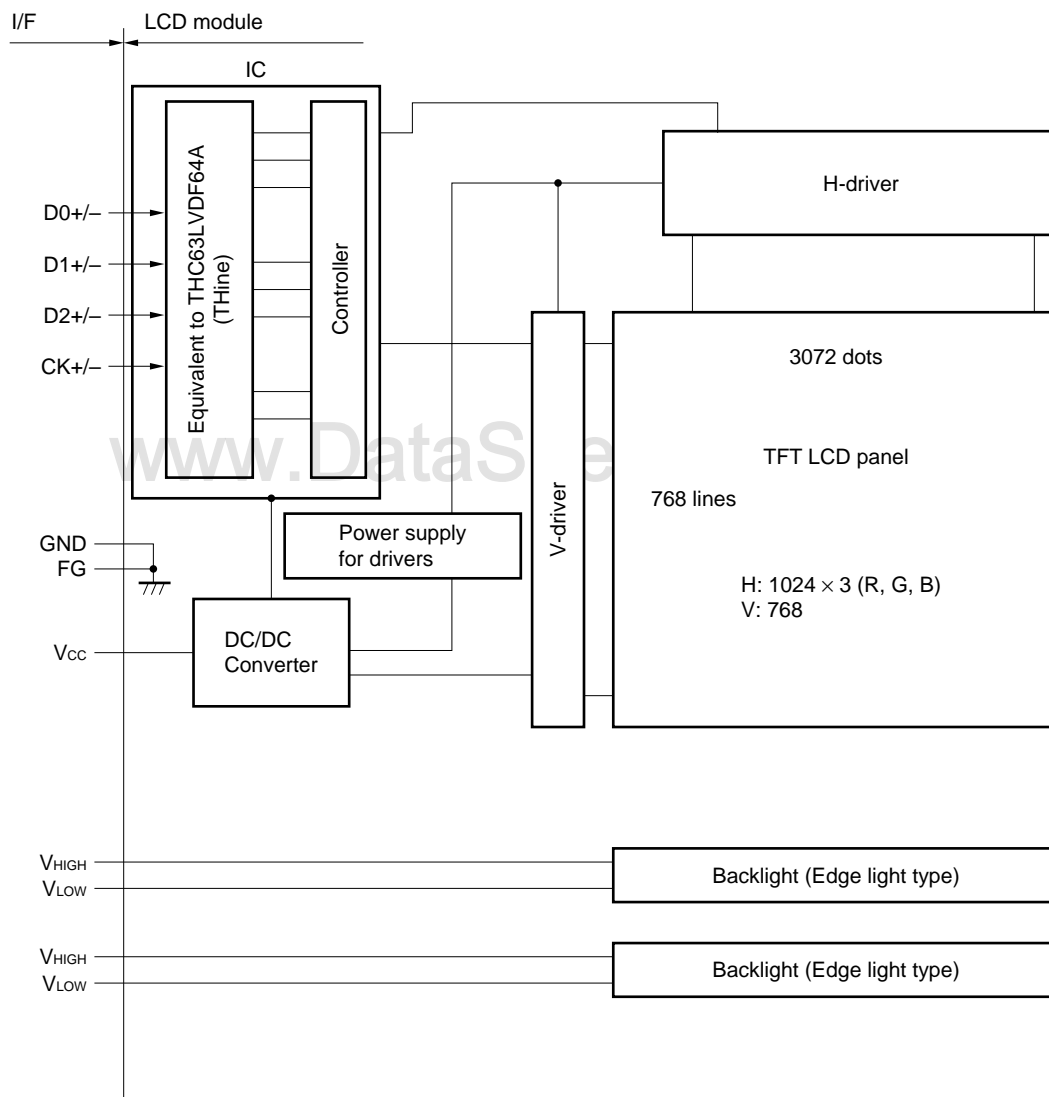

Note: GND is connected to FG (frame ground) inside the LCD module.

CHARACTERISTICS (at room temperature)

Item	Description
Display area	285.696 (H) × 214.272 (V) mm
Drive system	a-Si TFT active matrix
Display colors	262,144 colors
Number of pixels	1024 × 768 pixels
Pixel arrangement	RGB vertical stripe
Pixel pitch	0.279 (H) × 0.279 (V) mm
Module size	330.0 (H) × 255.0 (V) × 17.3 typ. (D) mm
Weight	1150 g (typ.)
Contrast ratio	150:1 (typ.)
Viewing angle (more than the contrast ratio of 10:1)	<ul style="list-style-type: none"> Horizontal: 50° (typ., left side, right side) Vertical: 20° (typ., up side); 35° (typ., down side)
Designed viewing direction	<ul style="list-style-type: none"> Best contrast angle: down side 5° Wider viewing angle without image reversal: up side (12 o'clock) Optimum gray-scale (r = 2.2): perpendicular
Color gamut	40% (typ., at center, to NTSC)
Response time	11 ms (typ.), "white 100%" to "black 10%"
Luminance	200 cd/m ² (typ., at IL = 6.1 mA rms/lamp)
Signal system	RGB 6-bit signals, synchronous signals (Hsync, Vsync), dot clock (CLK) LVDS interface (equivalent to the THC63LVDF64A, THine Electronics, Inc.)
Supply voltage	5 V (logic, LCD driving)
Backlight	Edge light type: Two cold cathode fluorescent lamps in a holder <ul style="list-style-type: none"> Lamp holder: Type no.141 LHS08
Power consumption	9.5 W (typ., at IL = 6.1 mA rms/lamp)

GENERAL SPECIFICATIONS

Item	Description	Unit
Module size	330 ± 0.5 (H) × 255.0 ± 0.5 (V) × 18.5 max. (D)	mm
Display area	285.696 (H) × 214.272 (V) [Diagonal display area: 36 cm (14.1 inches)]	mm
Number of pixels	1024 × 3 (H) × 768 (V)	pixel
Dot pitch	0.093 (H) × 0.279 (V)	mm
Pixel pitch	0.279 (H) × 0.279 (V)	mm
Pixel arrangement	RGB (red, green, blue) vertical stripe	–
Display colors	262,144 (RGB, 6 bit)	color
Weight	1150 (typ.), 1300 (max.)	g

ABSOLUTE MAXIMUM RATINGS

Parameter	Symbol	Rating	Unit	Remarks
Supply voltage	V _{CC}	–0.3 to +6.0	V	T _a = 25°C
Logic input voltage	V _i	–0.3 to V _{CC} +0.3	V	
Lamp voltage	V _L	2000	V _{rms}	
Storage temp.	T _{ST}	–20 to +60	°C	–
Operating temp.	T _{OP}	0 to +50	°C	Module surface Note 1
Relative humidity (RH)	Note 2	≤ 95%	%	T _a ≤ 40°C
		≤ 85%	%	40 < T _a ≤ 50°C
Absolute humidity	Note 2	Absolute humidity shall not exceed T _a = 50°C, 85% relative humidity level.	g/m ³	T _a > 50°C

- Notes:** 1. Measured at the panel surface (including self-heat)
2. No condensation

ELECTRICAL CHARACTERISTICS

(1) Logic, LCD Driving

T_a = 25°C

Parameter	Symbol	Min.	Typ.	Max.	Unit	Remarks
Supply voltage	V _{CC}	4.75	5.0	5.25	V	–
Ripple voltage	V _{RP}	–	–	100	mV	for V _{CC}
Differential input “L” threshold voltage	V _{TL}	–100	–	–	mV	V _{CM} = 1.2 V V _{CM} : Common mode voltage in LVDS driver
Differential input “H” threshold voltage	V _{TH}	–	–	+100	mV	
Differential input voltage	V _i	0.25	0.35	0.45	V	R _T = 100 Ω
Common mode voltage	V _{CM}	1.125	1.25	1.375	V	R _T = 100 Ω
Terminating resistor	R _T	–	100	–	Ω	–
Supply current	I _{CC}	–	270 Note	600	mA	V _{CC} = 5.0 V

Note: Checker flag pattern (in EIAJ ED-2522)

(2) Backlight

T_a = 25°C

Parameter	Symbol	Min.	Typ.	Max.	Unit	Remarks
Lamp current	I _L	3.0	6.1	6.5	mA rms	–
Lamp voltage	V _L	–	650	–	V rms	I _L = 6.1 mA rms
Lamp turn-on voltage Note 1	V _S	1050	–	–	V rms	T _a = 25°C
		1550	–	–	V rms	T _a = 0°C
Oscillator frequency	F _t	53	–	67	KHz	Note 2

Notes: 1. When V_S is less than the minimum value, lamps might not turn on.

2. Recommended value of F_t.

- F_t is within the specification.

- $F_t = \frac{1}{4} th \times (2n - 1)$ th: Hsync period
n: a natural number (1, 2, 3...)

If F_t is out of the recommended value, interference between F_t frequency and Hsync frequency may cause beat on the display.

SUPPLY VOLTAGE SEQUENCE

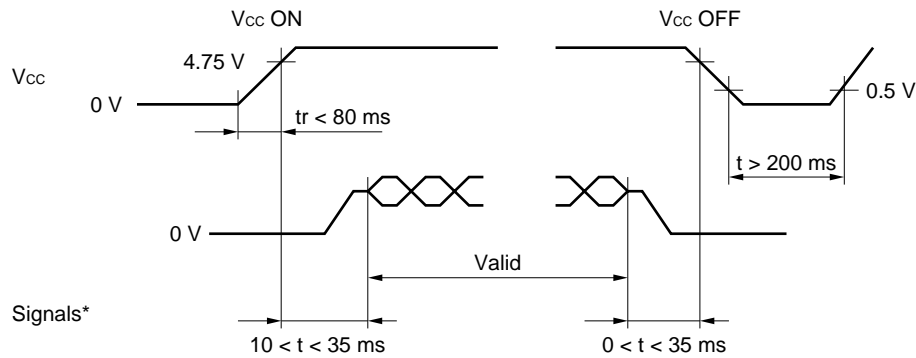

* The termination of the signal line is connected to resistance 100 Ω .

- Notes:**
1. Logic signals (synchronous signals and control signals) must be "0" voltage (V), when V_{cc} is not applied. If input voltage to signal lines is higher than 0.3 V, the internal circuit will be damaged.
 2. The supply voltage for input signals should be the same as V_{cc} .
 3. Turn on the backlight within the LCD operation period. When the backlight turns on before LCD operation or the LCD operation turns off before the backlight turns off, the display may momentarily become white.
 4. When the power is off, keep whole signals at low level or high impedance.
 5. This LCD module uses fuse as follows.

Fuse

	Type Name	Productor	Rating
V_{cc}	KAB2402162	MATSUO ELECTRIC Co., Ltd.	24 V/16 A

Before the power is designed, the fuses should be considered. The power capacity should be use more than 1.5 times of fuse rating.

In case of small power capacity, the module should be evaluated enough.

INTERFACE AND CONNECTOR PIN ASSIGNMENT

(1) Interface Connector for Signal and Power

CN1

Part no.: FI-SE20P-HF

Adaptable socket: FI-SE20M

Supplier: Japan Aviation Electronics Industry, Limited (JAE)

Pin No.	Symbol	Signal Type	Function
1	GND	Ground	Note
2	GND		
3	NC	Nonconnection	-
4	NC		
5	GND	Ground	Note
6	CK+	Pixel clock	CLK for pixel data $f = 65$ MHz (typ.) (LVDS level)
7	CK-		
8	GND	Ground	Note
9	D2+	Pixel data	LVDS differential data input
10	D2-		
11	GND	Ground	Note
12	D1+	Pixel data	LVDS differential data input
13	D1-		
14	GND	Ground	Note
15	D0±	Pixel data	LVDS differential data input
16	D0-		
17	GND	Ground	Note
18	GND		
19	V _{cc}	+5.0 V power supply	Supply +5.0 V ±5%
20	V _{cc}		

Note: GND is a signal ground for logic and LCD driving. GND is connected to FG (frame ground) inside the module.

Remarks: Connect all pins (except 3 and 4) to avoid noise.
Use 100 Ω twisted-pair wires for the cable.

CN1: Figure from socket view

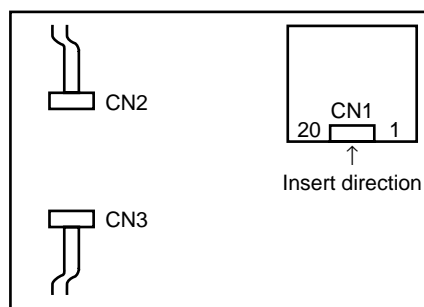
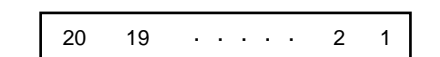

(2) Connector for Backlight Unit

CN2, 3

Part no.: BHR-03VS-1

Adaptable socket: SM02 (8.0)B-BHS-TB

Supplier: J.S.T. Trading Company, Ltd.

Pin No.	Symbol	Function
1	V _{LOW}	Low-voltage terminal (The cable color is gray.)
2	NC	Nonconnection
3	V _{HIGH}	High-voltage terminal (The cable color is white.)

Note: V_H and V_L must be connected correctly. If they are not connected correctly, the user may get hurt and the module may break.

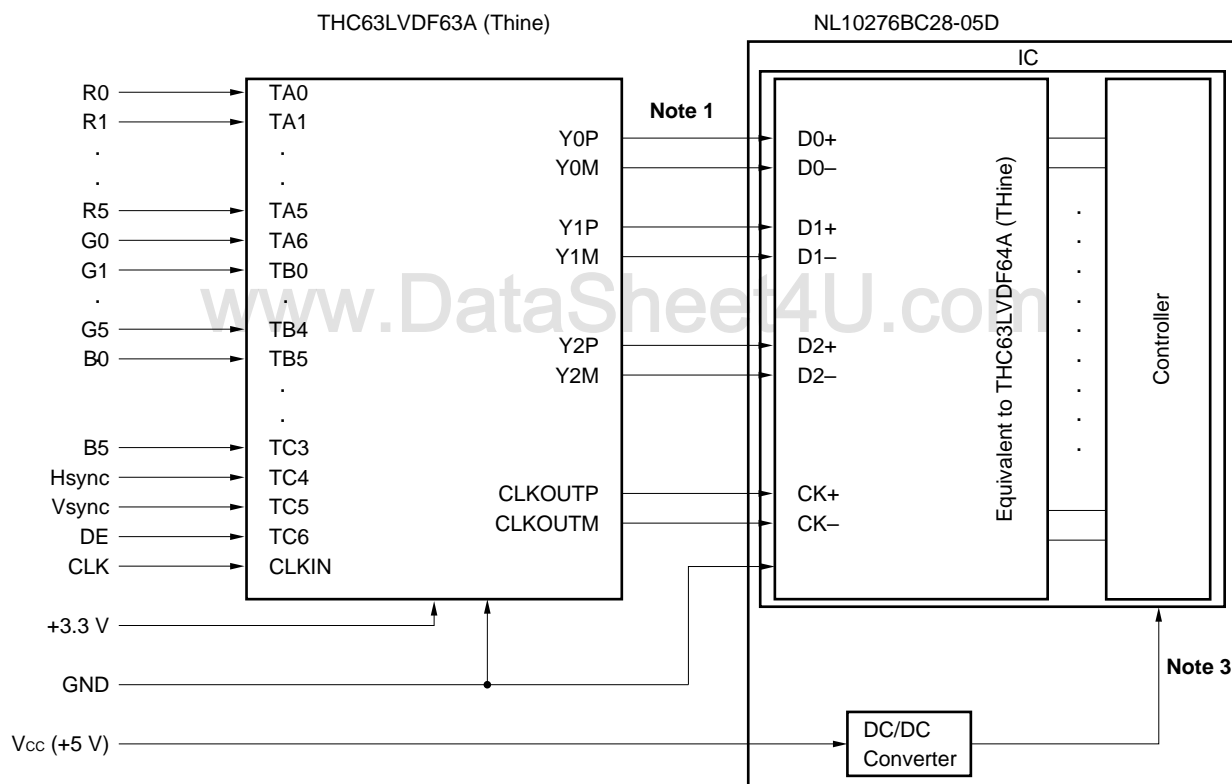
CONNECTING THE THC63LVDF63A

- Notes:**
1. 100 Ω twisted pair
 2. These signals should be kept in the range specified in **INPUT SIGNAL TIMINGS**.
 3. V_{cci} = 3.3 V (LCD internal voltage)

DISPLAY COLORS vs. INPUT DATA SIGNALS

Display Colors		Data Signal (0: Low Level; 1: High Level)																	
		R5	R4	R3	R2	R1	R0	G5	G4	G3	G2	G1	G0	B5	B4	B3	B2	B1	B0
Basic colors	Black	0	0	0	0	0	0	0	0	0	0	0	0	0	0	0	0	0	0
	Blue	0	0	0	0	0	0	0	0	0	0	0	0	1	1	1	1	1	1
	Red	1	1	1	1	1	1	0	0	0	0	0	0	0	0	0	0	0	0
	Magenta	1	1	1	1	1	1	0	0	0	0	0	0	1	1	1	1	1	1
	Green	0	0	0	0	0	0	1	1	1	1	1	1	0	0	0	0	0	0
	Cyan	0	0	0	0	0	0	1	1	1	1	1	1	1	1	1	1	1	1
	Yellow	1	1	1	1	1	1	1	1	1	1	1	1	0	0	0	0	0	0
	White	1	1	1	1	1	1	1	1	1	1	1	1	1	1	1	1	1	1
Red gray-scale	Black	0	0	0	0	0	0	0	0	0	0	0	0	0	0	0	0	0	0
		0	0	0	0	0	1	0	0	0	0	0	0	0	0	0	0	0	0
	dark	0	0	0	0	1	0	0	0	0	0	0	0	0	0	0	0	0	0
	↑				↓														
	↓				↑														
	bright	1	1	1	1	0	1	0	0	0	0	0	0	0	0	0	0	0	0
	Red	1	1	1	1	1	0	0	0	0	0	0	0	0	0	0	0	0	0
Green gray-scale	Black	0	0	0	0	0	0	0	0	0	0	0	0	0	0	0	0	0	0
		0	0	0	0	0	0	0	0	0	0	1	0	0	0	0	0	0	0
	dark	0	0	0	0	0	0	0	0	0	1	0	0	0	0	0	0	0	0
	↑				↓														
	↓				↑														
	bright	0	0	0	0	0	0	1	1	1	1	0	1	0	0	0	0	0	0
	Green	0	0	0	0	0	0	1	1	1	1	1	1	0	0	0	0	0	0
Blue gray-scale	Black	0	0	0	0	0	0	0	0	0	0	0	0	0	0	0	0	0	0
		0	0	0	0	0	0	0	0	0	0	0	0	0	0	0	0	0	1
	dark	0	0	0	0	0	0	0	0	0	0	0	0	0	0	0	0	1	0
	↑				↓														
	↓				↑														
	bright	0	0	0	0	0	0	0	0	0	0	0	0	1	1	1	1	0	1
	Blue	0	0	0	0	0	0	0	0	0	0	0	0	1	1	1	1	1	1

Note: Colors are developed in combination with 6-bit signals (64 steps in gray-scale) of each primary red, green, and blue color. This process can result in up to 262,144 ($64 \times 64 \times 64$) colors.

INPUT SIGNAL TIMINGS

(1) Input Signal Specifications for the LCD Controller

Parameter		Symbol	min.	typ.	max.	Unit	Remarks	
CLK	Frequency	1/tc	60.0	65.0	68.0	MHz	-	
			-	15.385	-	ns		
	Rise, fall	tcrf	Note			ns	-	
	Duty	tch/tc				-	-	
Hsync	Period	th	16.0	20.676	-	μ s	48.363 kHz (typ.)	
			110	1344	1780	CLK		
	Display period	thd	-	1024	-	CLK	-	
	Front porch	thf	0	-	-	CLK	-	
	Pulse width	thp*	12	-	-	CLK	-	
	Back porch	thb	2	-	-	CLK	-	
	*thp + thb			86	-	-	CLK	-
	Hsync-CLK timing	ths	Note			ns	-	
	CLK-Hsync timing	thh				ns	-	
	DE-CLK timing	tcs				ns	-	
	CLK-DE timing	tch				ns	-	
	Rise, fall	thrf, terf				ns	-	
	Vsync	Period	tv	-	16.666	-	ms	60.004 Hz (typ.)
780				806	-	H		
Display period		tvd	768			H	-	
Front porch		tvf	1	-	-	H	-	
Pulse width		tvp*	1	3	36	H	-	
Back porch		tvb*	1	-	36	H	-	
*tvp + tvb			3	-	38	H	-	
Vsync-Hsync timing		tvhs	1	-	-	ns	-	
Hsync-Vsync timing		tvhs	1	-	-	CLK	-	
Rise, fall	tvrf	Note			ns	-		
DATA (R0-R5) (G0-G5) (B0-B5)	DATA-CLK (setup)	tds				ns	-	
	CLK-DATA (hold)	tdh				ns	-	

Notes: These values are in the timing regulation of the THC63LVDF64A (THine).

The product equivalent of the THC63LVDF63A (THine) is recommended for the input of the LVDS transmitter.

The timing regulation prescribes in the input of the LVDS transmitter.

(2) Definition of Input Signal Timing for the LCD Controller

<Vertical>

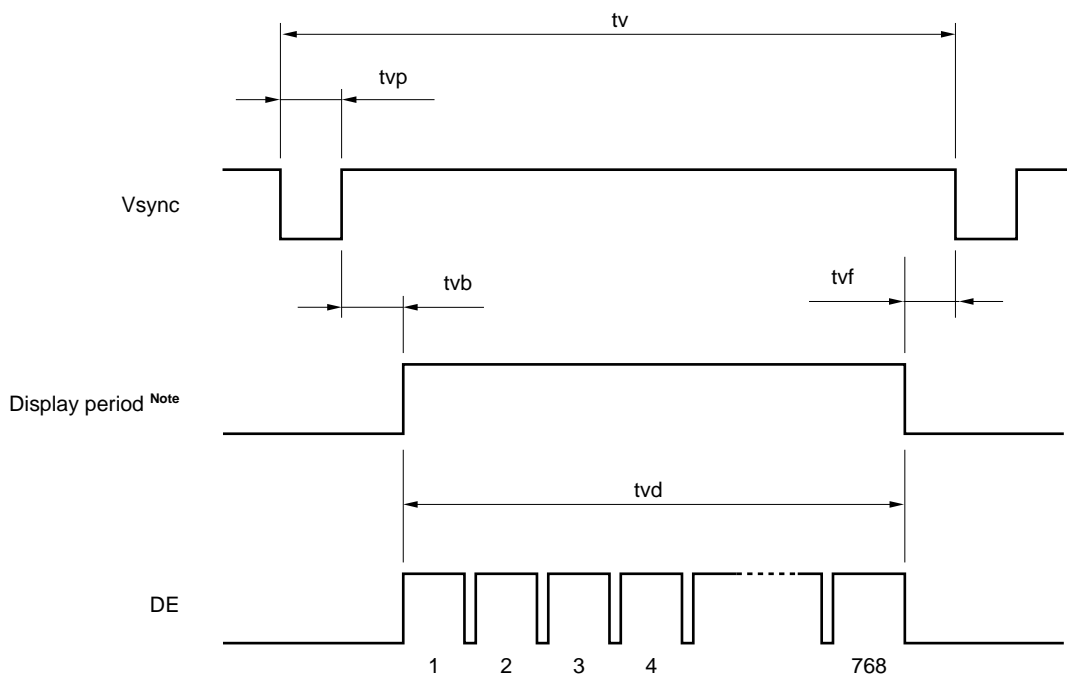

<Horizontal>

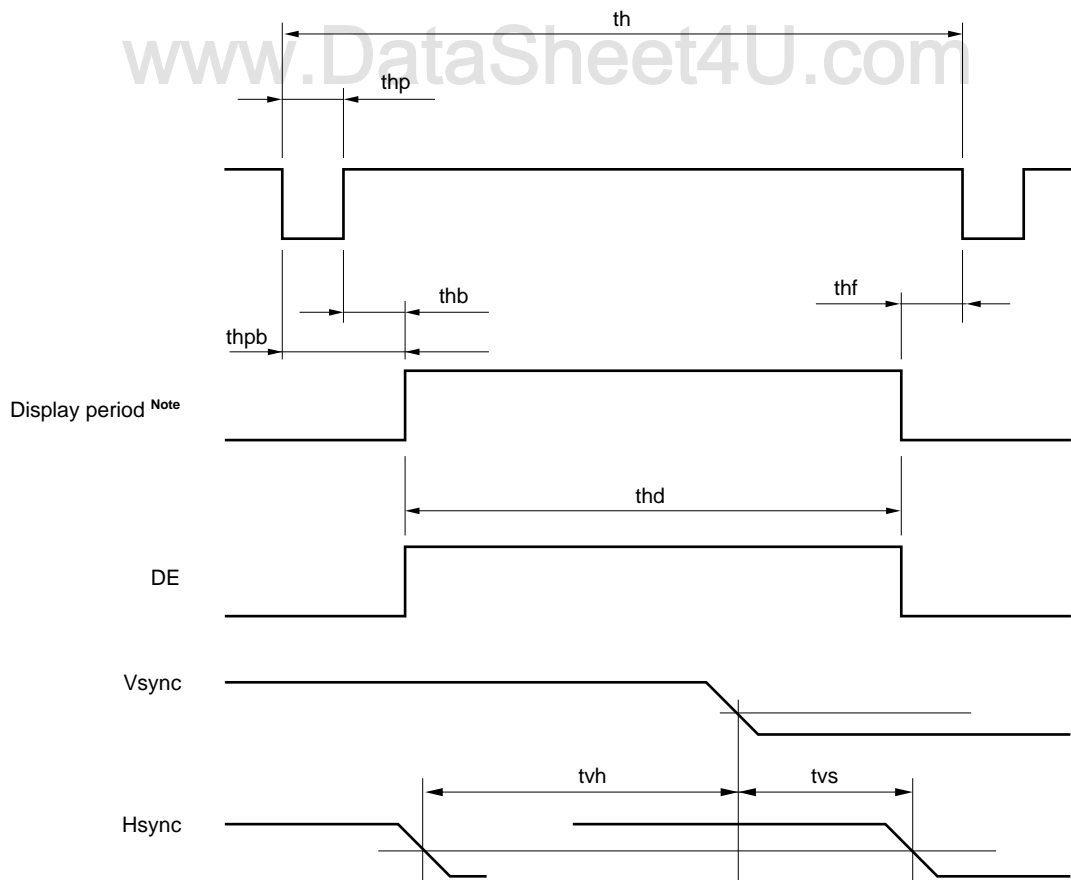

- Notes:**
1. "Display period" does not exist as signals.
 2. These values are in the output of THC63LVDF64A.
(Refer to **CONNECTING THE THC63LVDF63A**)

(3) Input Signal Timing Chart

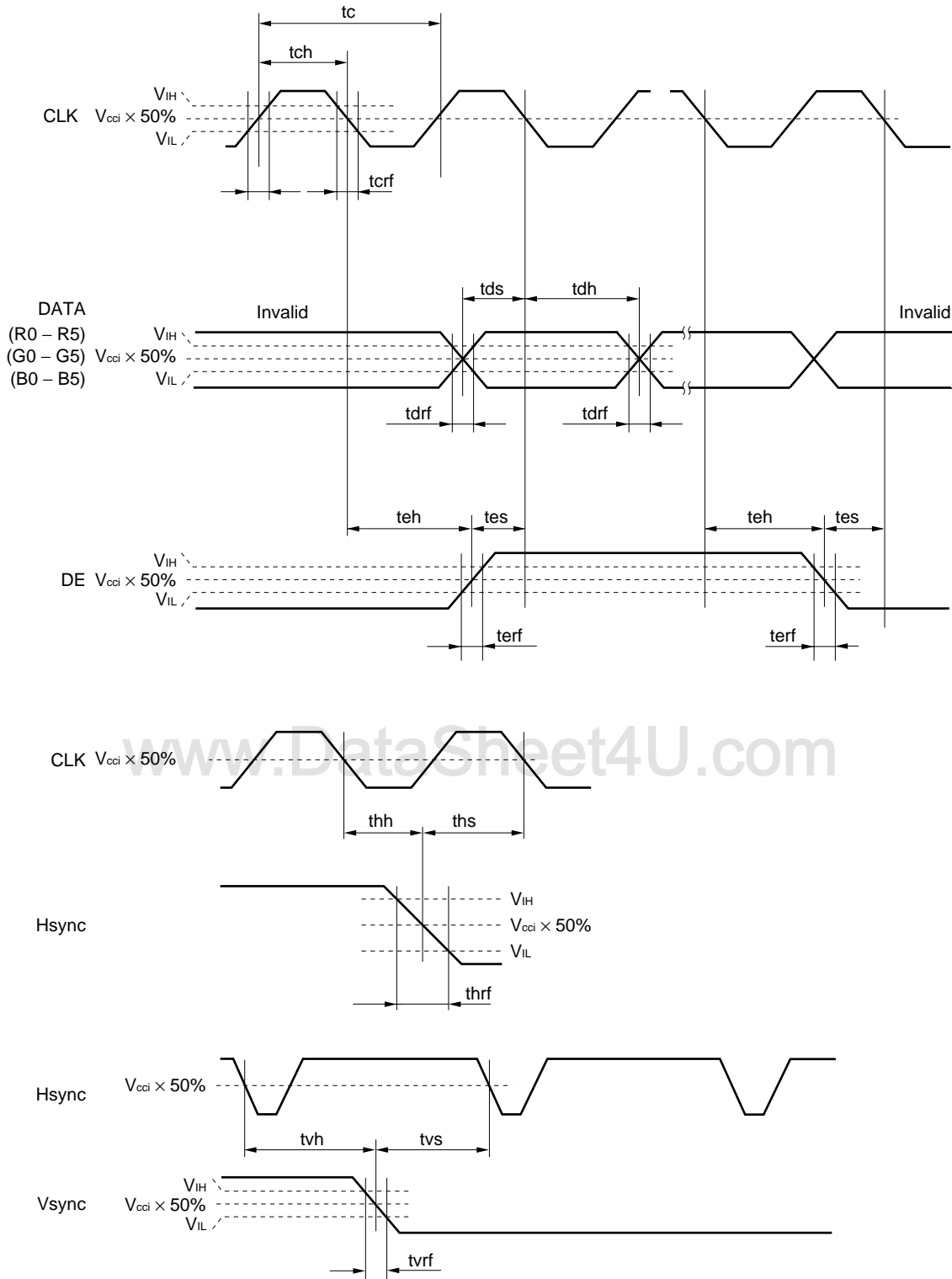

Note: V_{IH} , V_{IL} : Refer to the LVDS transmitter specifications.

(4) DE

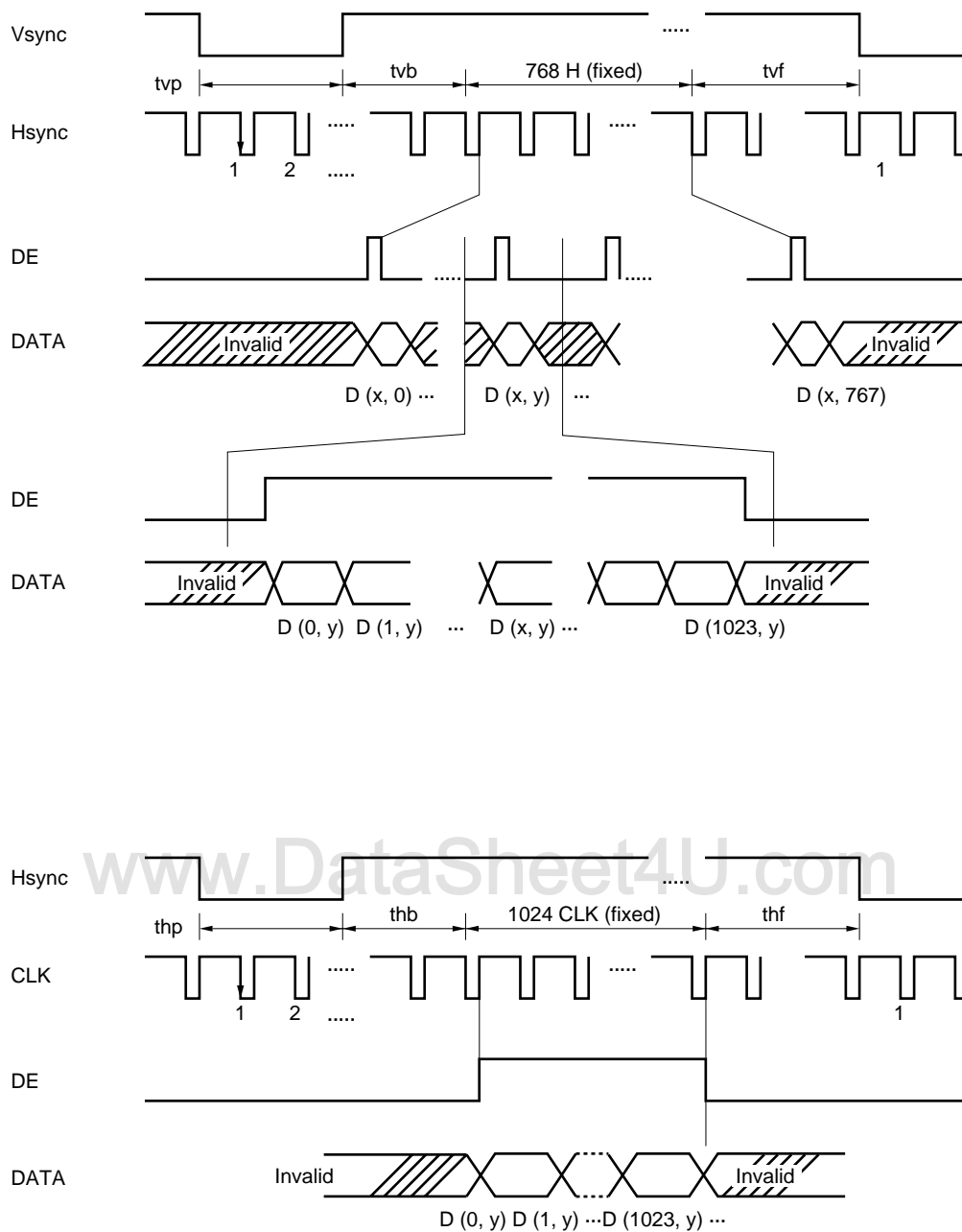

Note: These values are in the output of the THC63LVDF64A (refer to **CONNECTING THE THC63LVDF63A**).

(5) Display Position of Input Data

D (0, 0)	D (1, 0)	---	D (X, 0)	---	D (1022, 0)	D (1023, 0)
D (0, 1)	D (1, 1)	---	D (X, 1)	---	D (1022, 1)	D (1023, 1)
┆	┆	┆+	┆	┆+	┆	┆
D (0, Y)	D (1, Y)	---	D (X, Y)	---	D (1022, Y)	D (1023, Y)
┆	┆	┆+	┆	┆+	┆	┆
D (0, 766)	D (1, 766)	---	D (X, 766)	---	D (1022, 766)	D (1023, 766)
D (0, 767)	D (1, 767)	---	D (X, 767)	---	D (1022, 767)	D (1023, 767)

www.DataSheet4U.com

LVDS RECEIVER

(1) Input Signal Specifications

Parameter	Symbol	Min.	Typ.	Max.	Unit	Remarks
CLK frequency	TRCP	14.71	T	16.66	ns	T = 15.38 ns
Bit 0 position	TRIP1	-0.5	0	+0.5	ns	
Bit 1 position	TRIP0	T/7-0.5	T/7	T/7+0.5	ns	
Bit 2 position	TRIP6	2T/7-0.5	2T/7	2T/7+0.5	ns	
Bit 3 position	TRIP5	3T/7-0.5	3T/7	3T/7+0.5	ns	
Bit 4 position	TRIP4	4T/7-0.5	4T/7	4T/7+0.5	ns	
Bit 5 position	TRIP3	5T/7-0.5	5T/7	5T/7+0.5	ns	
Bit 6 position	TRIP2	6T/7-0.5	6T/7	6T/7+0.5	ns	

(2) Input Signal Timing Chart

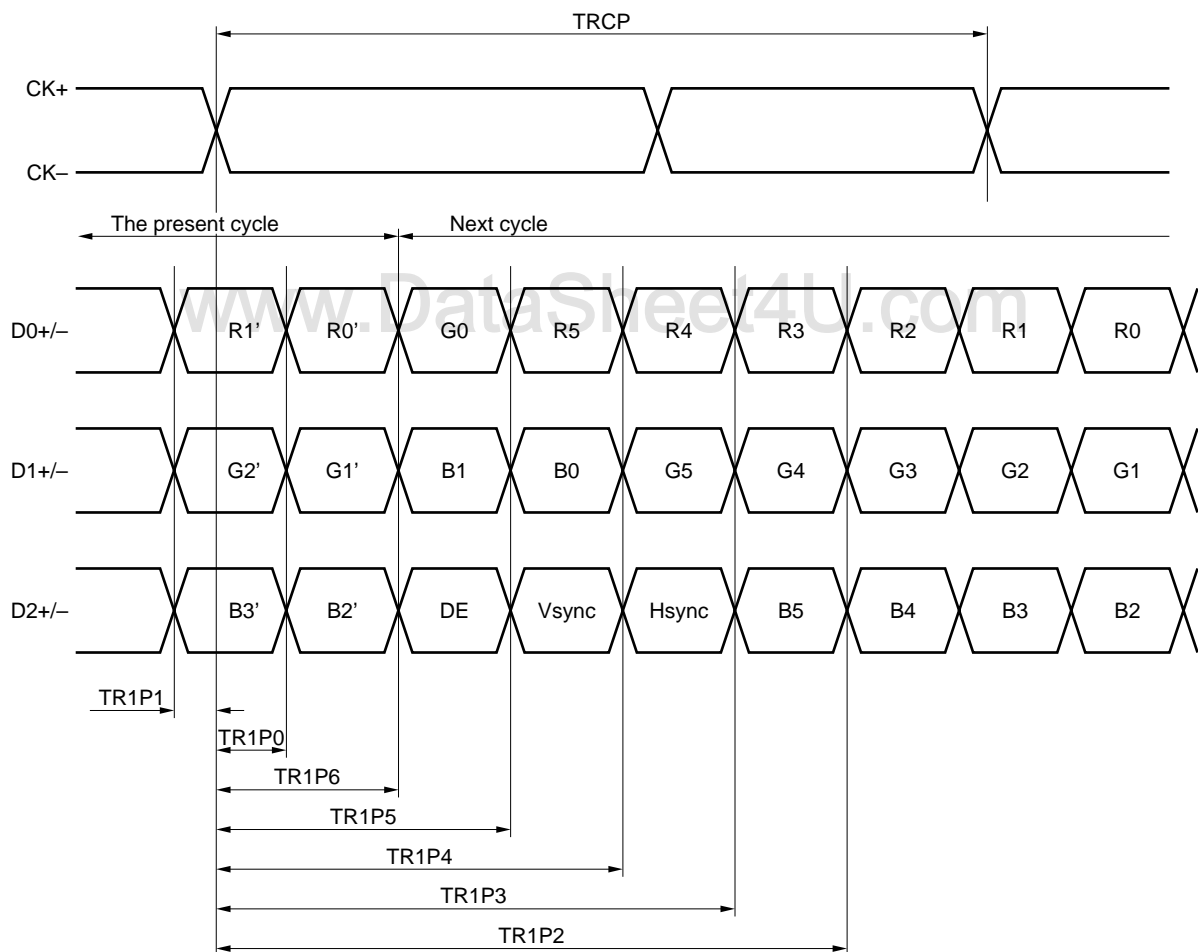

OPTICAL CHARACTERISTICS

(T_a = 25°C; Notes 1, 2)

Parameter	Symbol	Condition	Min.	Typ.	Max.	Unit	Remark
Contrast ratio	CR	At center	80	150	–	–	Note 3
Luminance	Lumax	"White" at center	150	200	–	cd/m ²	–
Luminance uniformity	–	Maximum/Minimum	–	–	1.30	–	Note 4

Reference data

(T_a = 25°C; V_{CC} = 5 V; V_{DDB} = 12 V)

Parameter	Symbol	Condition	Min.	Typ.	Max.	Unit	Remark	
Contrast ratio	CR	Best contrast angle, θ _X = ±0°, θ _Y = –5°, at center	–	300	–	–	Note 3	
Color gamut	C	To NTSC, at center	35	40	–	%	Note 2	
Viewing angle range	Horizontal	θ _{X+}	CR > 10, θ _Y = ±0°	40	50	–	deg.	Note 5
		θ _{X–}	CR > 10, θ _Y = ±0°	40	50	–	deg.	
	Vertical	θ _{Y+}	CR > 10, θ _X = ±0°	15	20	–	deg.	
		θ _{Y–}	CR > 10, θ _X = ±0°	25	35	–	deg.	
Response time	ton	White to black	–	11	25	ms	Note 6	
	toff	Black to white	–	40	80			

Notes: 1. The luminance is measured after the module has been working for 20 minutes, with all pixels in white. Typical value is measured after luminance saturation.

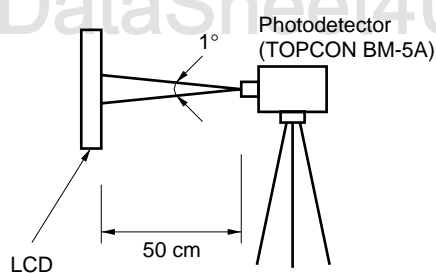

- Viewing angle is $\theta_x = \pm 0^\circ$, $\theta_y = \pm 0^\circ$
- The contrast ratio is calculated by using the following formula.

$$\text{Contrast ratio (CR)} = \frac{\text{Luminance with all pixels in white}}{\text{Luminance with all pixels in black}}$$

The luminance is measured in a darkroom.

4. Luminance uniformity is calculated using the following formula.

$$\text{Luminance uniformity} = \frac{\text{Maximum Luminance}}{\text{Minimum Luminance}}$$

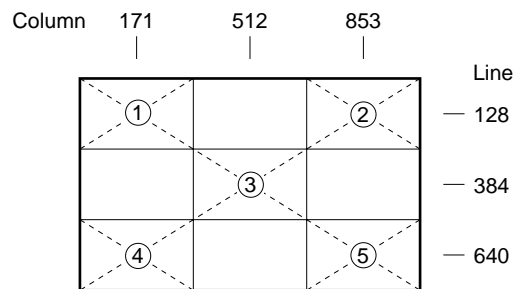

5. Definitions of viewing angles are as follows.

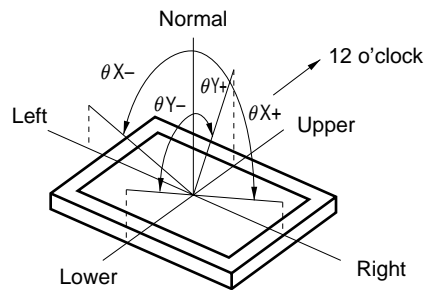

6. Definition of response time is as follows.

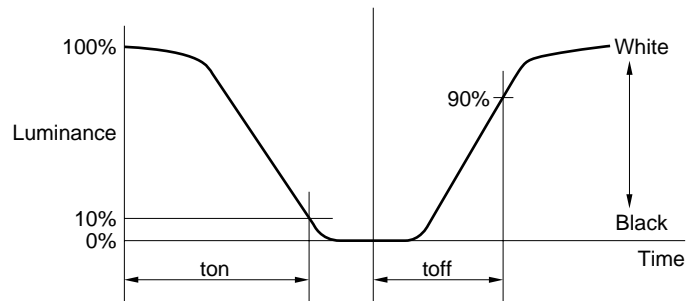

RELIABILITY TESTS

Test Item	Test Condition
High temperature/humidity operation Note 1	50 ± 2°C, 85% relative humidity 240 hours Display data is black.
Heat cycle (operation) Note 1	<1> 0°C ± 3°C ... 1 hour 55°C ± 3°C ... 1 hour <2> 50 cycles, 4 hours/cycle <3> Display data is black.
Thermal shock (nonoperation) Note 1	<1> -20°C ± 3°C ... 30 minutes 60°C ± 3°C ... 30 minutes <2> 100 cycles <3> Temperature transition time within 5 minutes
Vibration (nonoperation) Notes 1, 2	<1> 5–100 Hz, 19.6 m/s ² (2G) 1 minute/cycle X, Y, Z direction <2> 50 times each direction
Mechanical shock (nonoperation) Notes 1, 2	<1> 294 m/s ² (30 G), 11 ms X, Y, Z direction <2> 3 times each direction
ESD (operation) Notes 1, 3	150 pF, 150 Ω, ±10 kV 9 places on a panel 10 times each place at one-second intervals
Dust (operation) Note 1	15 kinds of dust (JIS Z 8901) Hourly 15 seconds stir, 8 times repeat

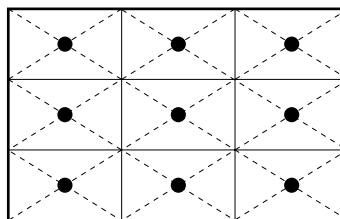

- Notes:**
1. Display function is checked by the same condition as the LCD module outgoing inspection.
 2. Physical damage.
 3. Discharge points ● are shown in the figure below.



GENERAL CAUTIONS

The figures and statements below are very important. Please be sure you understand their contents completely.

	CAUTION	This mark indicates that you will get hurt and/or the module will be damaged if you make a mistake in operation.
---	----------------	--

	This mark indicates that you will get an electric shock if you make a mistake in operation.	
	This mark indicates that you will get hurt if you make a mistake in operation.	

CAUTION

	Do not touch an inverter, on which there is a caution label, while the LCD module is in operation, because of dangerous high voltage.
---	---

(1) Caution when taking out the module

- a) Pick up the pouch only, when removing the module from a carrier box.

(2) Cautions for handling the module

- a) As electrostatic discharges may break the LCD module, handle the LCD module with care against electrostatic discharges.
- b)  As the LCD panel and backlight element are made from fragile glass material, impact and pressure to the LCD module should be avoided.
- c) As the surface of the polarizer is very soft and easily scratched, use a soft dry cloth without chemicals for cleaning.
- d) Do not pull the interface connectors in or out while the LCD module is operating.
- e) Put the module display side down on a flat horizontal plane.
- f) Handle connectors and cables with care.
- g) When the module is operating, do not lose the CLK, Hsync, or Vsync signal. If any one of these signals is lost, the LCD panel will be damaged.
- h) The torque for mounting screws should never exceed 0.392 N·m (4 kgf·cm).
- i) Don't push or rub the surface of LCD modules.
If you do so, scratches or rubbing marks may be left on the surface of the modules.

(3) Cautions regarding atmosphere

- a) Dew-drop atmosphere should be avoided.
- b) Do not store and/or operate the LCD module in a high-temperature and/or high-humidity atmosphere. Storage in an anti-static pouch at room temperature is recommended.
- c) This module uses a cold cathode fluorescent lamp. Therefore, the lifetime of the lamp is shortened if the module is operated in a low-temperature environment.
- d) Do not operate the LCD module in a high magnetic field.

(4) Cautions about module characteristics

- a) Do not apply a fixed-pattern data signal for a long time to the module. It may cause image sticking. Please use screen savers if the display pattern is fixed for a long time.
- b) This module has retardation film, which may cause variation in the color hue at different viewing angles. Nonuniformity may appear on the screen during high-temperature operation.
- c) A light vertical stripe may be observed, depending on the display pattern. This is neither a defect nor a malfunction.
- d) Noise from the inverter circuit may be observed in the luminance control mode. This is neither a defect nor a malfunction.

(5) Other cautions

- a) Do not disassemble and/or reassemble the LCD module.
- b) Do not readjust variable resistors or switches in the module.
- c) When returning the module for repair, etc., please pack the module properly to avoid damage. We recommend using the original shipping packages.

The liquid crystal display has the following specific characteristics. These are neither defects nor malfunctions.

The optical characteristics of this module may be affected by the ambient temperature. This module has a cold cathode tube for backlight. Optical characteristics, like luminance or uniformity, will change over time.

Uneven brightness and/or small spots may be observed, depending on different display patterns.

www.DataSheet4U.com

OUTLINE DRAWING: Front View (Unit: mm)

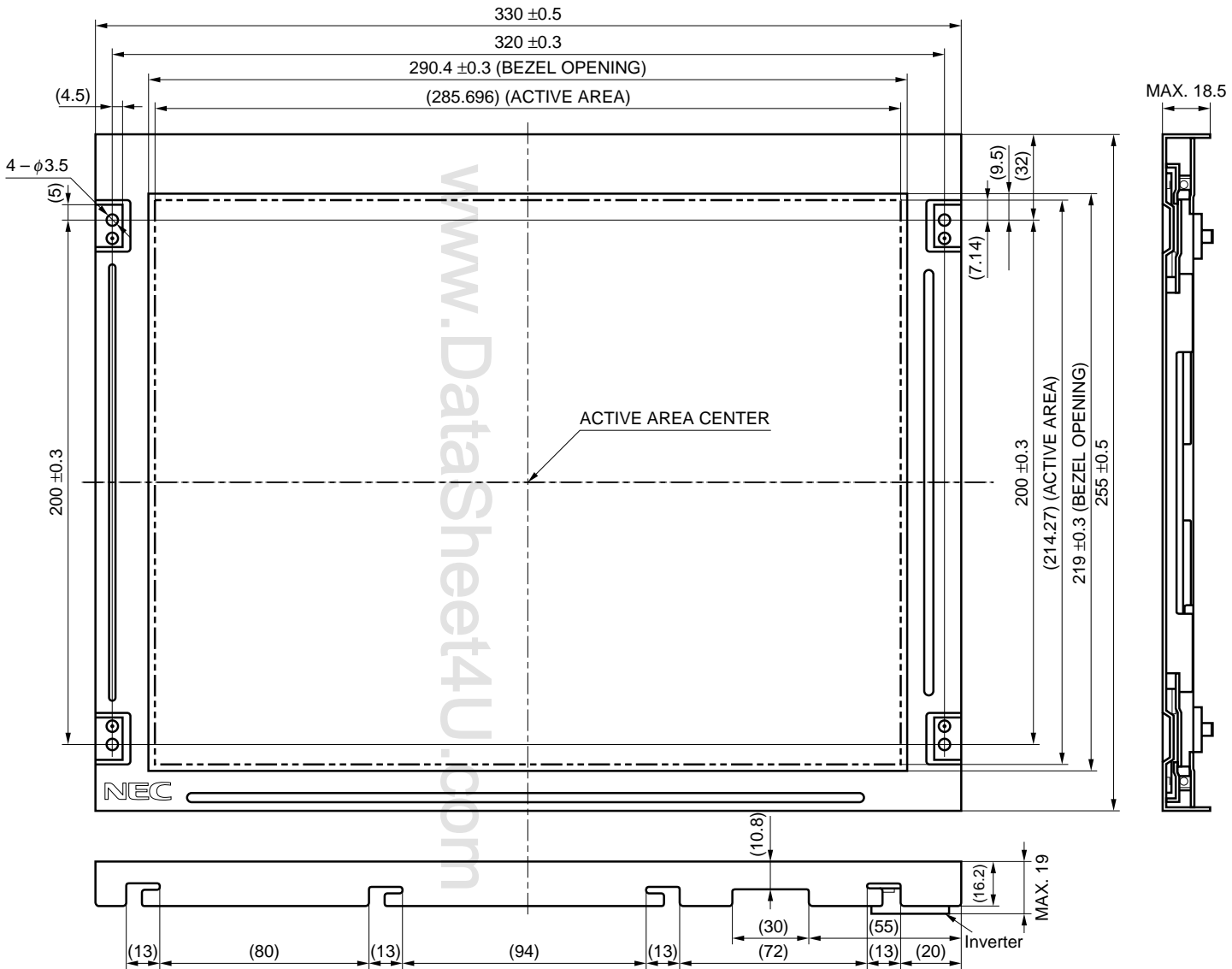

- Notes:**
1. Tolerance of the dimensions not shown is ± 0.5 mm.
 2. The torque on a mounting screw should never exceed 0.392 N-m (4 Kgf-cm).

OUTLINE DRAWING: Rear View (Unit: mm)

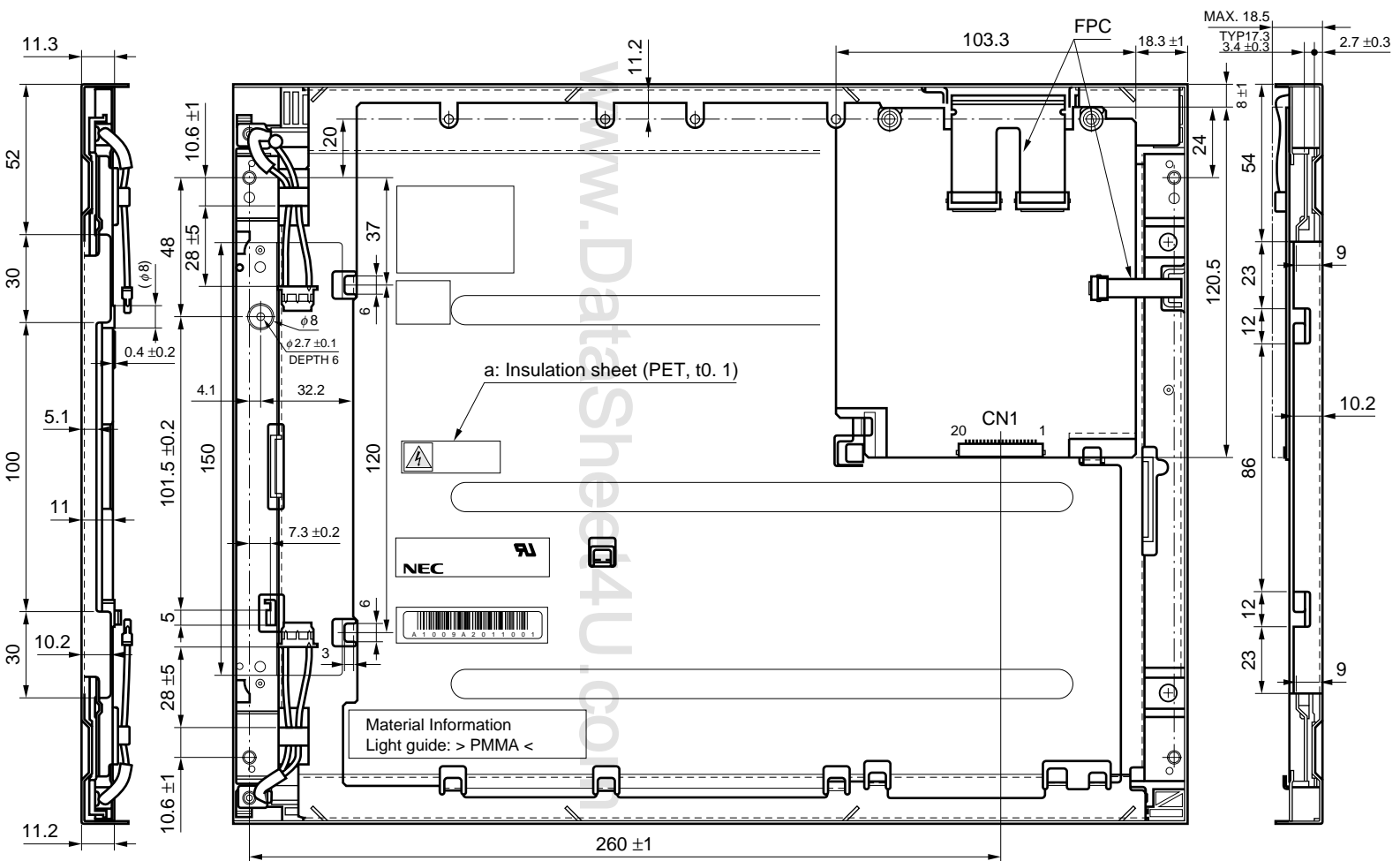

MEMO

www.DataSheet4U.com

No part of this document may be copied or reproduced in any form or by any means without the prior written consent of NEC Corporation. NEC Corporation assumes no responsibility for any errors which may appear in this document.

NEC Corporation does not assume any liability for infringement of patents, copyrights or other intellectual property rights of third parties by or arising from use of a device described herein or any other liability arising from use of such device. No license, either express, implied or otherwise, is granted under any patents, copyrights or other intellectual property rights of NEC Corporation or others.

While NEC Corporation has been making continuous effort to enhance the reliability of its electronic components, the possibility of defects cannot be eliminated entirely. To minimize risks of damage or injury to persons or property arising from a defect in an NEC electronic component, customers must incorporate sufficient safety measures in its design, such as redundancy, fire-containment, and anti-failure features. NEC devices are classified into the following three quality grades:

"Standard," "Special," and "Specific". The Specific quality grade applies only to devices developed based on a customer designated "quality assurance program" for a specific application. The recommended applications of a device depend on its quality grade, as indicated below. Customers must check the quality grade of each device before using it in a particular application.

Standard: Computers, office equipment, communications equipment, test and measurement equipment, audio and visual equipment, home electronic appliances, machine tools, personal electronic equipment and industrial robots

Special: Transportation equipment (automobiles, trains, ships, etc.), traffic control systems, anti-disaster systems, anti-crime systems, safety equipment and medical equipment (not specifically designed for life support)

Specific: Aircrafts, aerospace equipment, submersible repeaters, nuclear reactor control systems, life support systems or medical equipment for life support, etc.

The quality grade of NEC devices is "Standard" unless otherwise specified in NEC's Data Sheets or Data Books. If customers intend to use NEC devices for applications other than those specified for Standard quality grade, they should contact an NEC sales representative in advance.

(Note)

- (1) "NEC" as used in this statement means NEC Corporation and also includes its majority-owned subsidiaries.
- (2) "NEC electronic component products" means any electronic component product developed or manufactured by or for NEC (as defined above).