

## LOW VOLTAGE DETECTOR R3111xxx1A/C Series

### ■ OUTLINE

The R3111 Series are voltage detector ICs with high detector threshold accuracy and ultra-low supply current by CMOS process, which can be operated at an extremely low voltage and is used for system reset as an example. Each of these ICs consists of a voltage reference unit, a comparator, resistors for detector threshold setting, an output driver and a hysteresis circuit. The detector threshold is fixed with high accuracy internally and does not require any adjustment. Two output types, Nch open drain type and CMOS type are available. The R3111 Series are operable at a lower voltage than that for the RX5VL Series, and can be driven by a single battery. Four types of packages, TO-92, SOT-89, SOT-23-5 and SC-82AB are available.

### ■ FEATURES

- Ultra-low Supply Current..... TYP. 0.8 $\mu$ A ( $V_{DD}=1.5V$ )
- Wide Range of Operating Voltage..... 0.7 to 10.0V( $T_{opt}=25^{\circ}C$ )
- Detector Threshold..... Stepwise setting with a step of 0.1V in the range of 0.9V to 6.0V is possible.
- High Accuracy Detector Threshold.....  $\pm 2.0\%$
- Low Temperature-Drift Coefficient of Detector Threshold..... TYP.  $\pm 100ppm/^{\circ}C$
- Two Output Types ..... Nch Open Drain and CMOS
- Four Types of Packages..... TO-92, SOT-89(Mini-power Mold), SOT-23-5 (Mini-mold), SC-82AB

### ■ APPLICATIONS

- CPU and Logic Circuit Reset
- Battery Checker
- Window Comparator
- Wave Shaping Circuit
- Battery Back-up Circuit
- Power Failure Detector

### ■ BLOCK DIAGRAMS

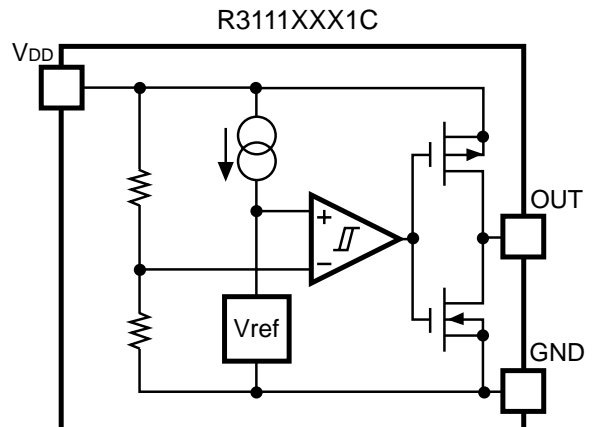
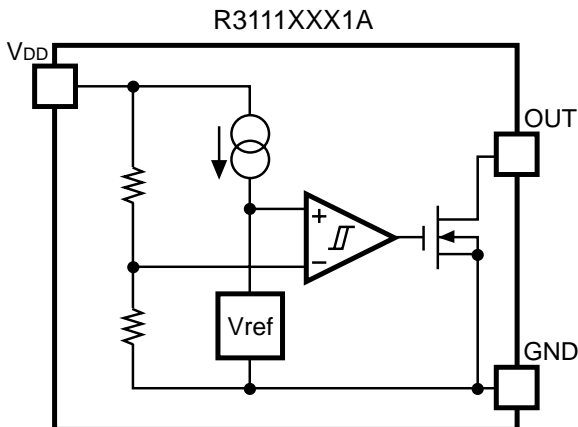

## ■ TIMING CHART

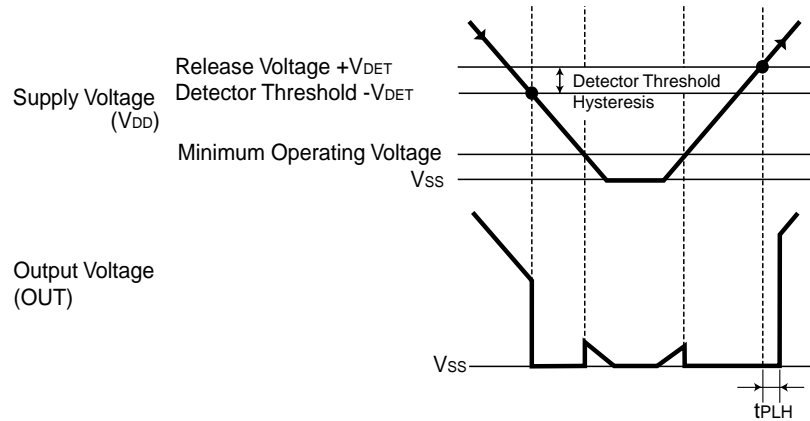

## ■ DEFINITION OF OUTPUT DELAY TIME

Output Delay Time  $t_{PLH}$  is defined as follows:

1. In the case of Nch Open Drain Output:

Under the condition of the output pin (OUT) is pulled up through a resistor of  $470k\Omega$  to 5V, the time interval between the rising edge of  $V_{DD}$  pulse from 0.7V to  $(+V_{DET}) + 2.0V$  and becoming of the output voltage to 2.5V.

2. In the case of CMOS Output:

The time interval between the rising edge of  $V_{DD}$  pulse from 0.7V to  $(+V_{DET}) + 2.0V$  and becoming of the output voltage to  $(V_{DD}/2)$  V.

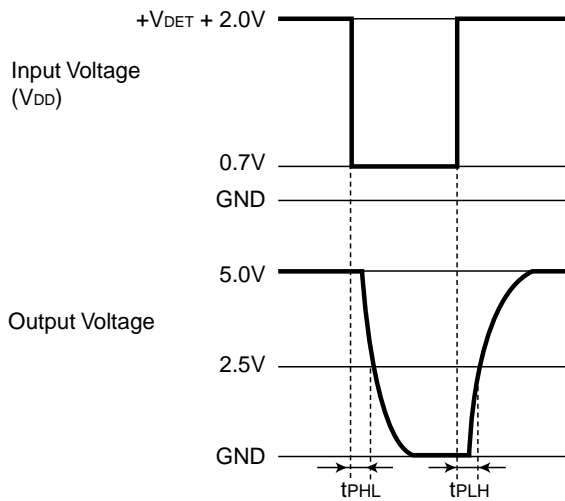

Nch Open Drain Output

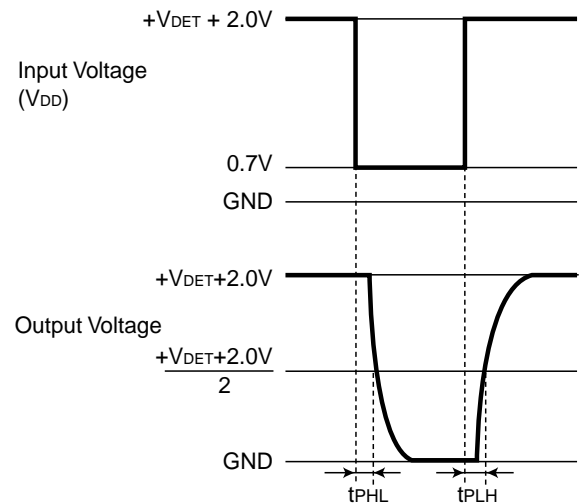

CMOS Output

## ■ SELECTION GUIDE

The package type, the detector threshold, the output type and the taping type of R3111 Series can be designated at the users' request by specifying the part number as follows;

R3111×××1×-×× ←Part Number  
 ↑↑ ↑↑  
 a b c d

Code	Contents
a	Designation of Package Type; E: TO-92                      Q: SC-82AB H: SOT-89                      N: SOT-23-5
b	Setting Detector Threshold ( $-V_{DET}$ ); Stepwise setting with a step of 0.1V in the range of 0.9V to 6.0V is possible.
c	Designation of Output Type; A: Nch Open Drain C: CMOS
d	Designation of Packing or Taping Type ; Ex. TO-92: TZ, SOT-89: T1, SOT-23-5, SC-82AB: TR are prescribed as standard directions. (Refer to Taping Specifications.) Antistatic bag for samples: C

## ■ PIN CONFIGURATION

● TO-92

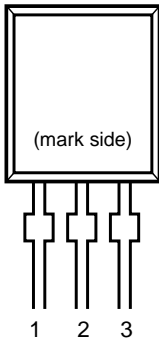

● SOT-89

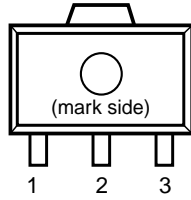

● SOT-23-5

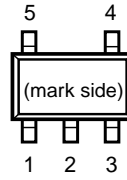

● SC-82AB

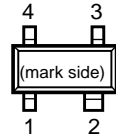

## ■ PIN DESCRIPTION

● TO-92

Pin No.	Symbol
1	V <sub>DD</sub>
2	GND
3	OUT

● SOT-89

Pin No.	Symbol
1	OUT
2	V <sub>DD</sub>
3	GND

● SOT-23-5

Pin No.	Symbol
1	OUT
2	V <sub>DD</sub>
3	GND
4	NC
5	NC

● SC-2AB

Pin No.	Symbol
1	OUT
2	V <sub>DD</sub>
3	NC
4	GND

## ■ ABSOLUTE MAXIMUM RATINGS

Symbol	Item	Rating	Unit
V <sub>DD</sub>	Supply Voltage	12	V
V <sub>OUT1</sub>	Output Voltage (CMOS)	V <sub>SS</sub> -0.3 to V <sub>DD</sub> +0.3	V
V <sub>OUT2</sub>	Output Voltage (Nch)	V <sub>SS</sub> -0.3 to 12	V
I <sub>OUT</sub>	Output Current	70	mA
P <sub>D</sub>	Power Dissipation 1 * <sup>Note1</sup>	300	mW
P <sub>D</sub>	Power Dissipation 2 * <sup>Note2</sup>	150	mW
T <sub>opt</sub>	Operating Temperature Range	-40 to 85	°C
T <sub>stg</sub>	Storage Temperature Range	-55 to 125	°C
T <sub>solder</sub>	Lead temperature (Soldering)	260°C, 10s	

\*Note 1: applied to SOT-89 and TO-92

\*Note 2: applied to SOT-23-5 and SC-82AB

## ■ ELECTRICAL CHARACTERISTICS

### ● R3111x091A/C

Topt=25°C

Symbol	Item	Conditions	MIN.	TYP.	MAX.	Unit
$-V_{DET}$	Detector Threshold		0.882	0.900	0.918	V
$V_{HYS}$	Detector Threshold Hysteresis		0.027	0.045	0.063	V
$I_{SS}$	Supply Current	$V_{DD}=0.80V$ $2.90V$		0.8 0.9	2.4 2.7	$\mu A$
$V_{DDH}$	Maximum Operating Voltage				10	V
$V_{DDL}$	Minimum Operating Voltage* <sup>Note1</sup>	$T_{opt}=25^{\circ}C$		0.55	0.70	V
		$-40^{\circ}C \leq T_{opt} \leq 85^{\circ}C$		0.65	0.80	
$I_{OUT}$	Output Current (Driver Output Pin)	Nch $V_{DS}=0.05V, V_{DD}=0.70V$	0.01	0.05		mA
		$V_{DS}=0.50V, V_{DD}=0.85V$	0.05	0.50		
		Pch $V_{DS}=-2.1V, V_{DD}=4.5V$	1.0	2.0		mA
$t_{PLH}$	Output Delay Time* <sup>Note2</sup>				100	$\mu s$
$\Delta-V_{DET}/\Delta T$	Detector Threshold Temperature Coefficient	$-40^{\circ}C \leq T_{opt} \leq 85^{\circ}C$		$\pm 100$		ppm/°C

### ● R3111x181A/C

Topt=25°C

Symbol	Item	Conditions	MIN.	TYP.	MAX.	Unit
$-V_{DET}$	Detector Threshold		1.764	1.800	1.836	V
$V_{HYS}$	Detector Threshold Hysteresis		0.054	0.090	0.126	V
$I_{SS}$	Supply Current	$V_{DD}=1.70V$ $3.80V$		0.8 1.0	2.4 3.0	$\mu A$
$V_{DDH}$	Maximum Operating Voltage				10	V
$V_{DDL}$	Minimum Operating Voltage* <sup>Note1</sup>	$T_{opt}=25^{\circ}C$		0.55	0.70	V
		$-40^{\circ}C \leq T_{opt} \leq 85^{\circ}C$		0.65	0.80	
$I_{OUT}$	Output Current (Driver Output Pin)	Nch $V_{DS}=0.05V, V_{DD}=0.70V$	0.01	0.05		mA
		$V_{DS}=0.50V, V_{DD}=0.85V$	1.00	2.00		
		Pch $V_{DS}=-2.1V, V_{DD}=4.5V$	1.0	2.0		mA
$t_{PLH}$	Output Delay Time* <sup>Note2</sup>				100	$\mu s$
$\Delta-V_{DET}/\Delta T$	Detector Threshold Temperature Coefficient	$-40^{\circ}C \leq T_{opt} \leq 85^{\circ}C$		$\pm 100$		ppm/°C

● R3111x271A/C

Topt=25°C

Symbol	Item	Conditions	MIN.	TYP.	MAX.	Unit
-V <sub>DET</sub>	Detector Threshold		2.646	2.700	2.754	V
V <sub>HYS</sub>	Detector Threshold Hysteresis		0.081	0.135	0.189	V
I <sub>SS</sub>	Supply Current	V <sub>DD</sub> =2.60V 4.70V		0.9 1.1	2.7 3.3	μA
V <sub>DDH</sub>	Maximum Operating Voltage				10	V
V <sub>DDL</sub>	Minimum Operating Voltage* <sup>Note1</sup>	Topt=25°C		0.55	0.70	V
		-40°C≤Topt≤85°C		0.65	0.80	
I <sub>OUT</sub>	Output Current (Driver Output Pin)	Nch V <sub>DS</sub> =0.05V, V <sub>DD</sub> =0.70V V <sub>DS</sub> =0.50V, V <sub>DD</sub> =1.50V	0.01 1.00	0.05 2.00		mA
		Pch V <sub>DS</sub> =-2.1V, V <sub>DD</sub> =4.5V	1.0	2.0		
t <sub>PLH</sub>	Output Delay Time* <sup>Note2</sup>				100	μs
Δ-V <sub>DET</sub> /ΔT	Detector Threshold Temperature Coefficient	-40°C≤Topt≤85°C		±100		ppm/°C

● R3111x361A/C

Topt=25°C

Symbol	Item	Conditions	MIN.	TYP.	MAX.	Unit
-V <sub>DET</sub>	Detector Threshold		3.528	3.600	3.672	V
V <sub>HYS</sub>	Detector Threshold Hysteresis		0.108	0.180	0.252	V
I <sub>SS</sub>	Supply Current	V <sub>DD</sub> =3.47V 5.60V		1.0 1.2	3.0 3.6	μA
V <sub>DDH</sub>	Maximum Operating Voltage				10	V
V <sub>DDL</sub>	Minimum Operating Voltage* <sup>Note1</sup>	Topt=25°C		0.55	0.70	V
		-40°C≤Topt≤85°C		0.65	0.80	
I <sub>OUT</sub>	Output Current (Driver Output Pin)	Nch V <sub>DS</sub> =0.05V, V <sub>DD</sub> =0.70V V <sub>DS</sub> =0.50V, V <sub>DD</sub> =1.50V	0.01 1.00	0.05 2.00		mA
		Pch V <sub>DS</sub> =-2.1V, V <sub>DD</sub> =4.5V	1.0	2.0		
t <sub>PLH</sub>	Output Delay Time* <sup>Note2</sup>				100	μs
Δ-V <sub>DET</sub> /ΔT	Detector Threshold Temperature Coefficient	-40°C≤Topt≤85°C		±100		ppm/°C

● R3111x451A/C

Topt=25°C

Symbol	Item	Conditions	MIN.	TYP.	MAX.	Unit
-V <sub>DET</sub>	Detector Threshold		4.410	4.500	4.590	V
V <sub>HYS</sub>	Detector Threshold Hysteresis		0.135	0.225	0.315	V
I <sub>SS</sub>	Supply Current	V <sub>DD</sub> =4.34V 6.50V		1.1 1.3	3.3 3.9	μA
V <sub>DDH</sub>	Maximum Operating Voltage				10	V
V <sub>DDL</sub>	Minimum Operating Voltage* <sup>Note1</sup>	Topt=25°C		0.55	0.70	V
		-40°C≤Topt≤85°C		0.65	0.80	
I <sub>OUT</sub>	Output Current (Driver Output Pin)	Nch V <sub>DS</sub> =0.05V, V <sub>DD</sub> =0.70V V <sub>DS</sub> =0.50V, V <sub>DD</sub> =1.50V	0.01 1.00	0.05 2.00		mA
		Pch V <sub>DS</sub> =-2.1V, V <sub>DD</sub> =8.0V	1.5	3.0		
t <sub>PLH</sub>	Output Delay Time* <sup>Note2</sup>				100	μs
Δ-V <sub>DET</sub> /ΔT	Detector Threshold Temperature Coefficient	-40°C≤Topt≤85°C		±100		ppm/°C

● R3111x541A/C

Topt=25°C

Symbol	Item	Conditions	MIN.	TYP.	MAX.	Unit
-V <sub>DET</sub>	Detector Threshold		5.292	5.400	5.508	V
V <sub>HYS</sub>	Detector Threshold Hysteresis		0.162	0.270	0.378	V
I <sub>SS</sub>	Supply Current	V <sub>DD</sub> =5.20V 7.40V		1.2 1.4	3.6 4.2	μA
V <sub>DDH</sub>	Maximum Operating Voltage				10	V
V <sub>DDL</sub>	Minimum Operating Voltage* <sup>Note1</sup>	Topt=25°C		0.55	0.70	V
		-40°C≤Topt≤85°C		0.65	0.80	
I <sub>OUT</sub>	Output Current (Driver Output Pin)	Nch V <sub>DS</sub> =0.05V, V <sub>DD</sub> =0.70V V <sub>DS</sub> =0.50V, V <sub>DD</sub> =1.50V	0.01 1.00	0.05 2.00		mA
		Pch V <sub>DS</sub> =-2.1V, V <sub>DD</sub> =8.0V	1.5	3.0		
t <sub>PLH</sub>	Output Delay Time* <sup>Note2</sup>				100	μs
Δ-V <sub>DET</sub> /ΔT	Detector Threshold Temperature Coefficient	-40°C≤Topt≤85°C		±100		ppm/°C

\*Note1: Minimum Operating Voltage means the value of input voltage when output voltage maintains 0.1V or less. (In the case of Nch Open Drain Type, Output pin is pulled up with a resistance of 470kΩ to 5.0V.)

\*Note2: In the case of CMOS Output Type: The time interval between the rising edge of V<sub>DD</sub> input pulse from 0.7V to (+V<sub>DET</sub>)+2.0V and output voltage level becoming to V<sub>DD</sub>/2.

In the case of Nch Open Drain Output Type: Output pin is pulled up with a resistance of 470kΩ to 5.0V, The time interval between the rising edge of V<sub>DD</sub> input pulse from 0.7V to (+V<sub>DET</sub>)+2.0V and output voltage level becoming to 2.5V.

## ELECTRICAL CHARACTERISTICS BY DETECTOR THRESHOLD

### R3111x09x to R3111x60x

Part Number	Detector Threshold			Detector Threshold Hysteresis			Supply Current 1			Supply Current 2																																				
	-V <sub>DET</sub> [V]			V <sub>HYS</sub> [V]			I <sub>SS1</sub> [μA]			I <sub>SS2</sub> [μA]																																				
	MIN.	TYP.	MAX.	MIN.	TYP.	MAX.	Condition	TYP.	MAX.	Condition	TYP.	MAX.																																		
R3111x091x	0.882	0.900	0.918	0.027	0.045	0.063	V <sub>DD</sub> = (-V <sub>DET</sub> ) -0.10V	0.8	2.4	1.0	0.9	2.7																																		
R3111x101x	0.980	1.000	1.020	0.030	0.050	0.070					0.9	2.7	1.1	3.3																																
R3111x111x	1.078	1.100	1.122	0.033	0.055	0.077									V <sub>DD</sub> = (-V <sub>DET</sub> ) -0.13V	1.0	3.0	1.2	3.6																											
R3111x121x	1.176	1.200	1.224	0.036	0.060	0.084														V <sub>DD</sub> = (-V <sub>DET</sub> ) -0.16V	1.1	3.3	1.3	3.9																						
R3111x131x	1.274	1.300	1.326	0.039	0.065	0.091																			V <sub>DD</sub> = (-V <sub>DET</sub> ) -0.20V	1.2	3.6	1.4	4.2																	
R3111x141x	1.372	1.400	1.428	0.042	0.070	0.098																								1.2	3.6	1.4	4.2													
R3111x151x	1.470	1.500	1.530	0.045	0.075	0.105																												1.2	3.6	1.4	4.2									
R3111x161x	1.568	1.600	1.632	0.048	0.080	0.112																																1.2	3.6	1.4	4.2					
R3111x171x	1.666	1.700	1.734	0.051	0.085	0.119																																				1.2	3.6	1.4	4.2	
R3111x181x	1.764	1.800	1.836	0.054	0.090	0.126																																								1.2
R3111x191x	1.862	1.900	1.938	0.057	0.095	0.133		1.2	3.6	1.4																																				
R3111x201x	1.960	2.000	2.040	0.060	0.100	0.140					1.2	3.6	1.4	4.2																																
R3111x211x	2.058	2.100	2.142	0.063	0.105	0.147									1.2	3.6	1.4	4.2																												
R3111x221x	2.156	2.200	2.244	0.066	0.110	0.154													1.2	3.6	1.4	4.2																								
R3111x231x	2.254	2.300	2.346	0.069	0.115	0.161																	1.2	3.6	1.4	4.2																				
R3111x241x	2.352	2.400	2.448	0.072	0.120	0.168																					1.2	3.6	1.4	4.2																
R3111x251x	2.450	2.500	2.550	0.075	0.125	0.175																									1.2	3.6	1.4	4.2												
R3111x261x	2.548	2.600	2.652	0.078	0.130	0.182																													1.2	3.6	1.4	4.2								
R3111x271x	2.646	2.700	2.754	0.081	0.135	0.189																																	1.2	3.6	1.4	4.2				
R3111x281x	2.744	2.800	2.856	0.084	0.140	0.196																																					1.2	3.6	1.4	4.2
R3111x291x	2.842	2.900	2.958	0.087	0.145	0.203	1.2	3.6	1.4	4.2																																				
R3111x301x	2.940	3.000	3.060	0.090	0.150	0.210					1.2	3.6	1.4	4.2																																
R3111x311x	3.038	3.100	3.162	0.093	0.155	0.217									1.2	3.6	1.4	4.2																												
R3111x321x	3.136	3.200	3.264	0.096	0.160	0.224													1.2	3.6	1.4	4.2																								
R3111x331x	3.234	3.300	3.366	0.099	0.165	0.231																	1.2	3.6	1.4	4.2																				
R3111x341x	3.332	3.400	3.468	0.102	0.170	0.238																					1.2	3.6	1.4	4.2																
R3111x351x	3.430	3.500	3.570	0.105	0.175	0.245																									1.2	3.6	1.4	4.2												
R3111x361x	3.528	3.600	3.672	0.108	0.180	0.252																													1.2	3.6	1.4	4.2								
R3111x371x	3.626	3.700	3.774	0.111	0.185	0.259																																	1.2	3.6	1.4	4.2				
R3111x381x	3.724	3.800	3.876	0.114	0.190	0.266																																					1.2	3.6	1.4	4.2
R3111x391x	3.822	3.900	3.978	0.117	0.195	0.273	1.2	3.6	1.4	4.2																																				
R3111x401x	3.920	4.000	4.080	0.120	0.200	0.280					1.2	3.6	1.4	4.2																																
R3111x411x	4.018	4.100	4.182	0.123	0.205	0.287									1.2	3.6	1.4	4.2																												
R3111x421x	4.116	4.200	4.284	0.126	0.210	0.294													1.2	3.6	1.4	4.2																								
R3111x431x	4.214	4.300	4.386	0.129	0.215	0.301																	1.2	3.6	1.4	4.2																				
R3111x441x	4.312	4.400	4.488	0.132	0.220	0.308																					1.2	3.6	1.4	4.2																
R3111x451x	4.410	4.500	4.590	0.135	0.225	0.315																									1.2	3.6	1.4	4.2												
R3111x461x	4.508	4.600	4.692	0.138	0.230	0.322																													1.2	3.6	1.4	4.2								
R3111x471x	4.606	4.700	4.794	0.141	0.235	0.329																																	1.2	3.6	1.4	4.2				
R3111x481x	4.704	4.800	4.896	0.144	0.240	0.336																																					1.2	3.6	1.4	4.2
R3111x491x	4.802	4.900	4.998	0.147	0.245	0.343	1.2	3.6	1.4	4.2																																				
R3111x501x	4.900	5.000	5.100	0.150	0.250	0.350					1.2	3.6	1.4	4.2																																
R3111x511x	4.998	5.100	5.202	0.153	0.255	0.357									1.2	3.6	1.4	4.2																												
R3111x521x	5.096	5.200	5.304	0.156	0.260	0.364													1.2	3.6	1.4	4.2																								
R3111x531x	5.194	5.300	5.406	0.159	0.265	0.371																	1.2	3.6	1.4	4.2																				
R3111x541x	5.292	5.400	5.508	0.162	0.270	0.378																					1.2	3.6	1.4	4.2																
R3111x551x	5.390	5.500	5.610	0.165	0.275	0.385																									1.2	3.6	1.4	4.2												
R3111x561x	5.488	5.600	5.712	0.168	0.280	0.392																													1.2	3.6	1.4	4.2								
R3111x571x	5.586	5.700	5.814	0.171	0.285	0.399																																	1.2	3.6	1.4	4.2				
R3111x581x	5.684	5.800	5.916	0.174	0.290	0.406																																					1.2	3.6	1.4	4.2
R3111x591x	5.782	5.900	6.018	0.177	0.295	0.413	1.2	3.6	1.4	4.2																																				
R3111x601x	5.880	6.000	6.120	0.180	0.300	0.420					1.2	3.6	1.4	4.2																																

Note 1: In the case of CMOS Output parts; when the voltage is forced to V<sub>DD</sub> from 0.7V to (+V<sub>DET</sub>)+2.0V, time interval between the rising edge of V<sub>DD</sub> and the reaching point at 50% of Output Voltage. In the case of Nch open Drain Output parts : Output pin is pulled up to 5V through 470kΩ, and when the voltage is forced to V<sub>DD</sub> from 0.7V to (+V<sub>DET</sub>)+2.0V, time interval between the rising edge of V<sub>DD</sub> and the reaching point at 50% of Output Voltage.

Note 2: V<sub>DD</sub> value when Output Voltage is equal or less than 0.1V. In the case of Nch Open Drain Output parts, Output pin is pulled up to 5V through 470kΩ resistor.

Condition 1: T<sub>opt</sub>=25°C

Condition 2: -40°C ≤ T<sub>opt</sub> ≤ 85°C



Output Current 1			Output Current 2			Output Delay Time	Minimum Operating Voltage		Detector Threshold Temperature Coefficient		
I <sub>OUT1</sub> [mA]			I <sub>OUT2</sub> [mA]			t <sub>PLH</sub> [μs]	V <sub>DDL</sub> [V]		ΔV <sub>DET</sub> /ΔT[ppm/°C]		
Condition	MIN.	TYP.	Condition	MIN.	TYP.	MAX.	TYP.	MAX.	Condition	TYP.	
Nch V <sub>DS</sub> =0.05V V <sub>DD</sub> =0.7V	0.01	0.05	Nch V <sub>DS</sub> =0.5V	V <sub>DD</sub> =0.85V	0.05	0.5	Note 1 100	Note 2	Note 2	-40°C ≤ T <sub>opt</sub> ≤85°C	±100
				V <sub>DD</sub> =1.0V	0.2	1.0					
				V <sub>DD</sub> =1.5V	1.0	2.0					

## OPERATION

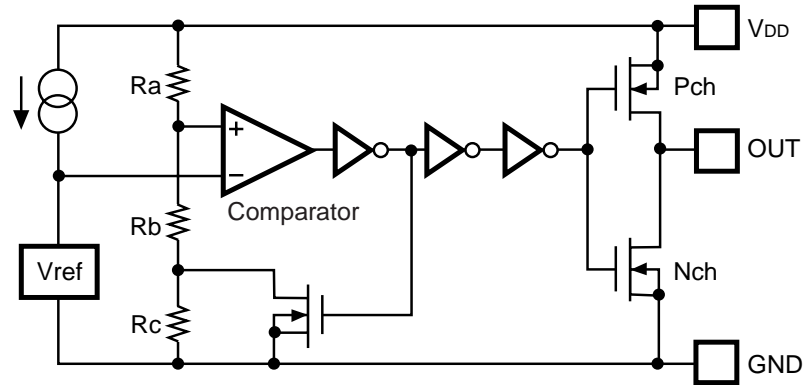

Figure 1. Block Diagram

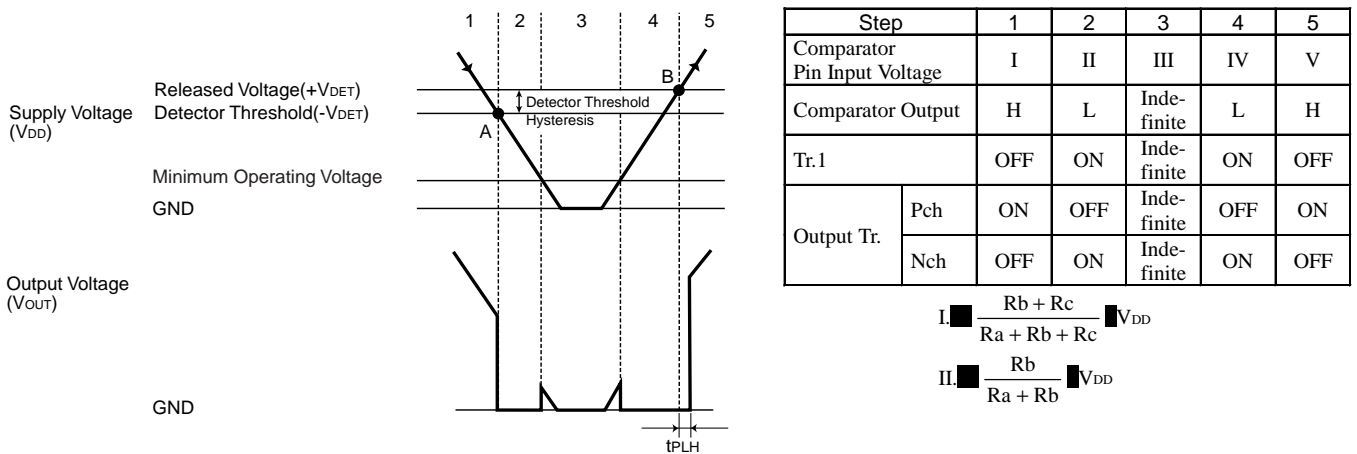

Figure 2. Operation Diagram

- Step 1. Output Voltage is equal to Supply Voltage ( $V_{DD}$ ).
  - Step 2. At Point "A",  $V_{ref} \geq V_{DD} \times (Rb + Rc) / (Ra + Rb + Rc)$  is true, as a result, the output of comparator is reverse, and output voltage becomes to GND level. The voltage level of Point A means detector threshold voltage, or ( $-V_{DET}$ ).
  - Step 3. When the supply voltage is less than minimum operating voltage, the operation of output transistor becomes indefinite, and in the case that output is pulled up to  $V_{DD}$ , Output voltage equals to  $V_{DD}$  voltage.
  - Step 4. Output Voltage equals to GND level.
  - Step 5. At Point "B",  $V_{ref} \leq V_{DD} \times Rb / (Ra + Rb)$  is true, Output of the comparator is reverse, and output voltage is equal to the supply voltage, or ( $V_{DD}$ ). The voltage level of Point B means released voltage, or ( $+V_{DET}$ ).
- \* The difference between Released Voltage and Detector Threshold Voltage is Detector Threshold Hysteresis.

## TEST CIRCUITS

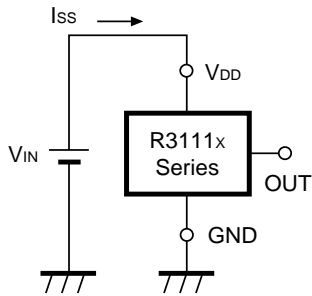
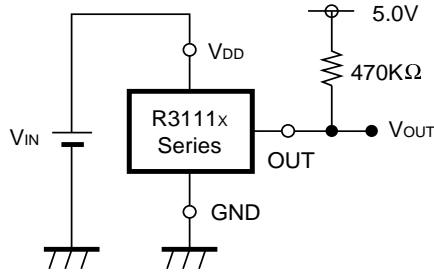

Figure 3. Supply Current Test Circuit



\*Pull-up circuit is not necessary for CMOS Output type, or R3111XXXXC.

Figure 4. Detector Threshold Test Circuit

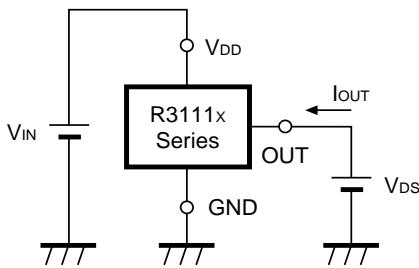
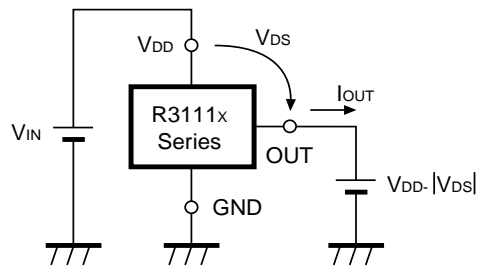

Figure 5. Nch Driver Output Current Test Circuit



\*Apply only to CMOS

Figure 6. Pch Driver Output Current Test Circuit

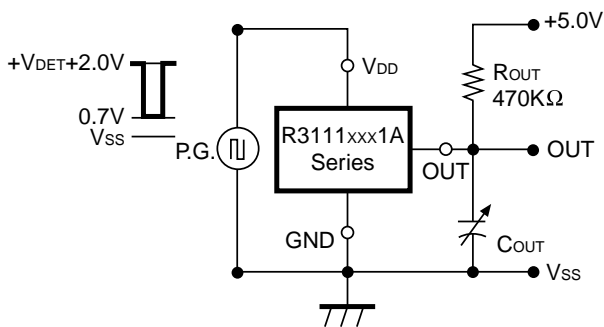

Figure 7. Output Delay Time Test Circuit (1)

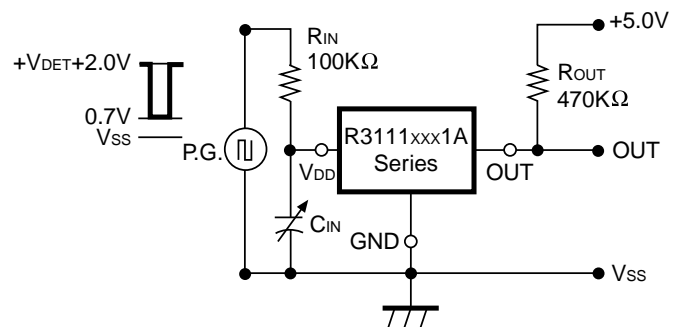
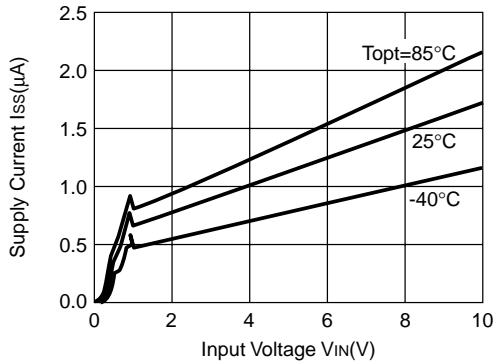

Figure 8. Output Delay Time Test Circuit (2)

## ■ TYPICAL CHARACTERISTICS

### 1) Supply Current vs. Input Voltage

R3111x091C



R3111x271C

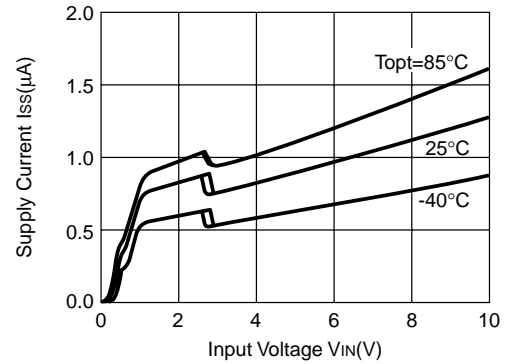

R3111x451C

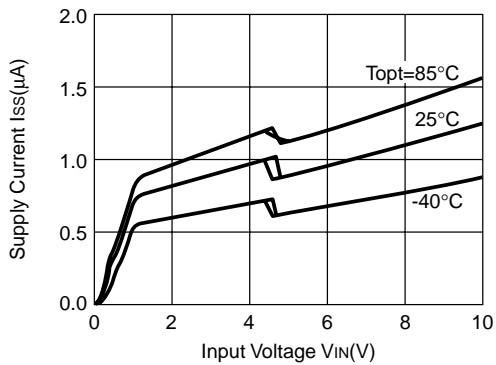

### 2) Detector Threshold Hysteresis vs. Temperature

R3111x091C

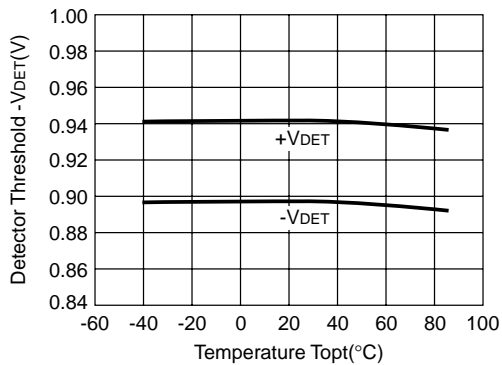

R3111x271C

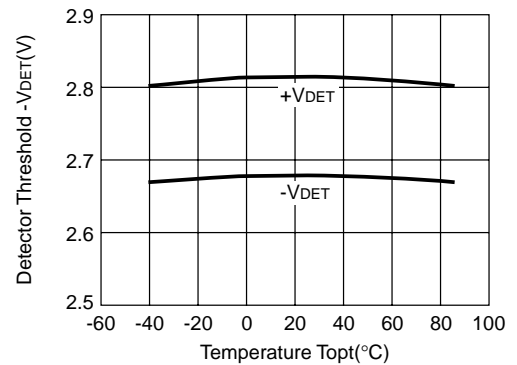

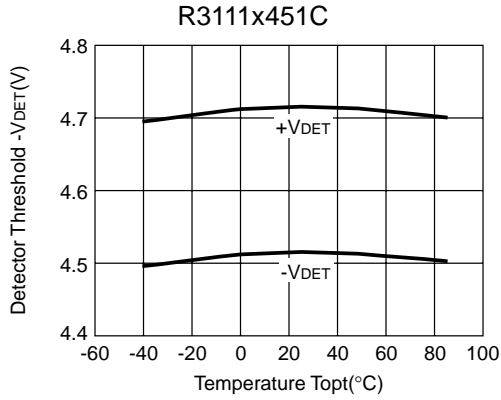

3) Output Voltage vs. Input Voltage

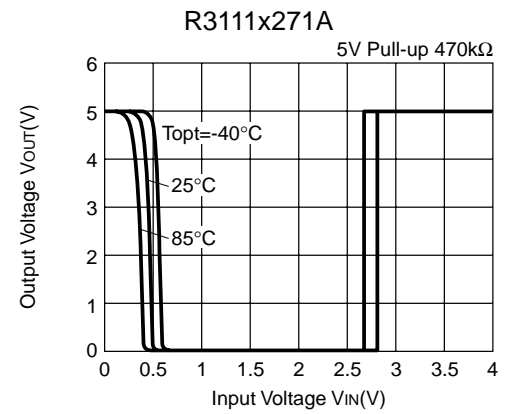
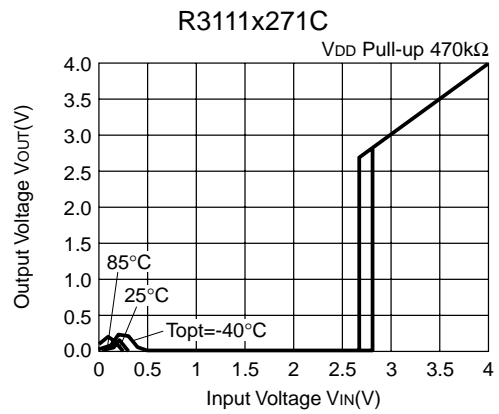
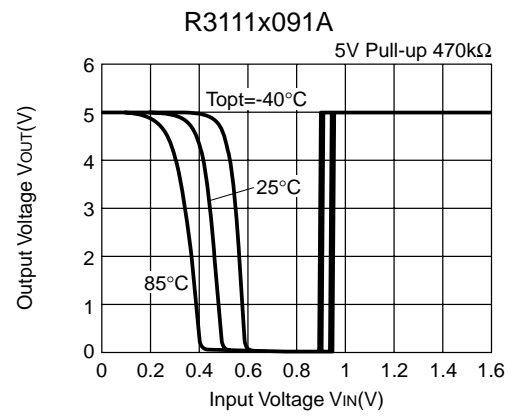
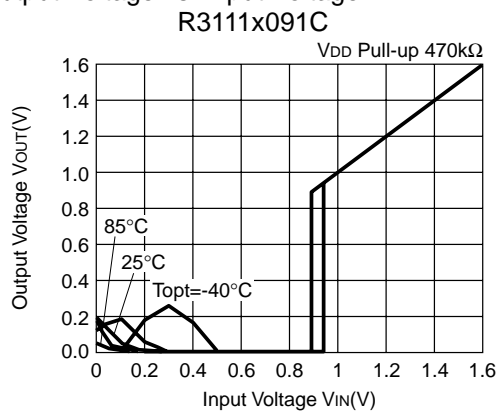

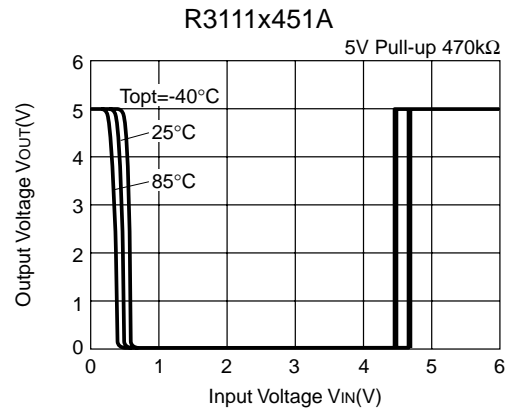
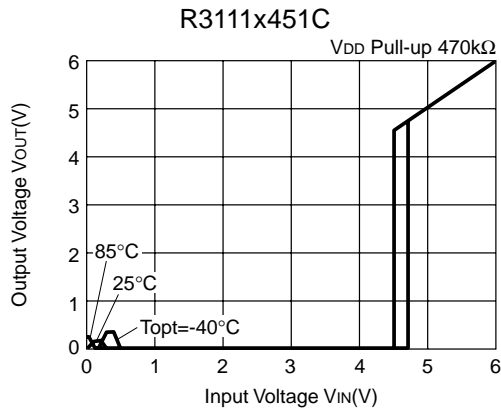

4) Nch Driver Output Current vs. V<sub>DS</sub>

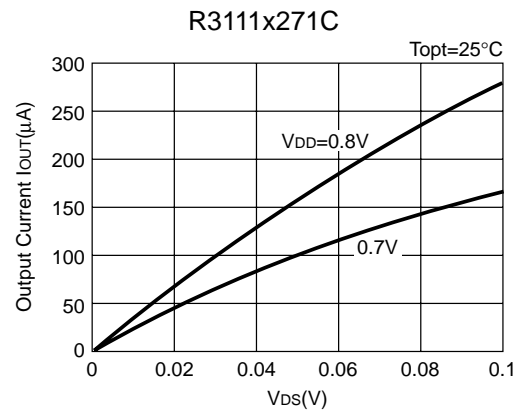
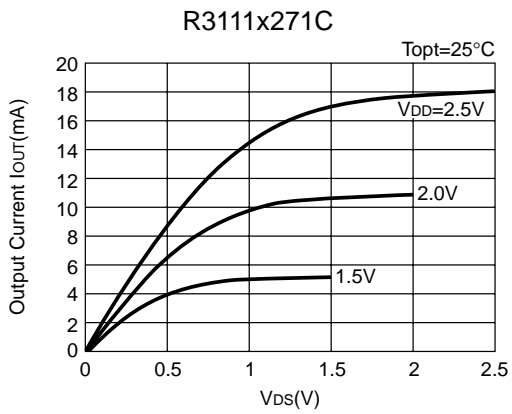
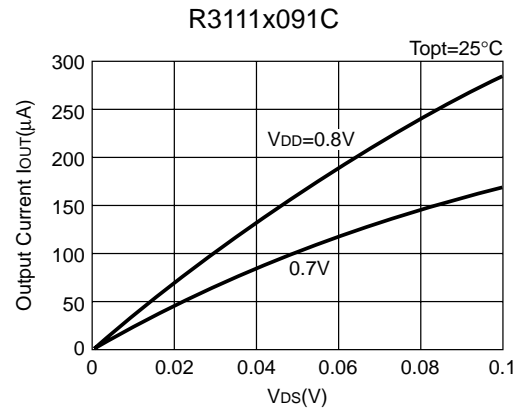
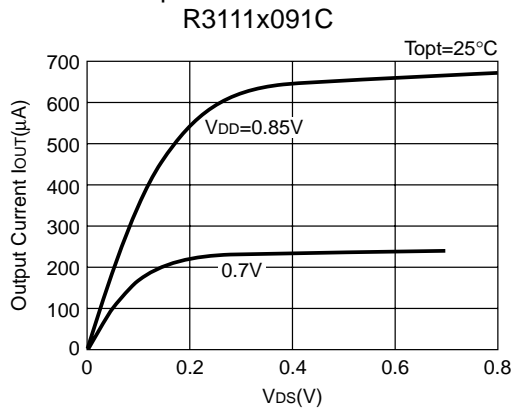

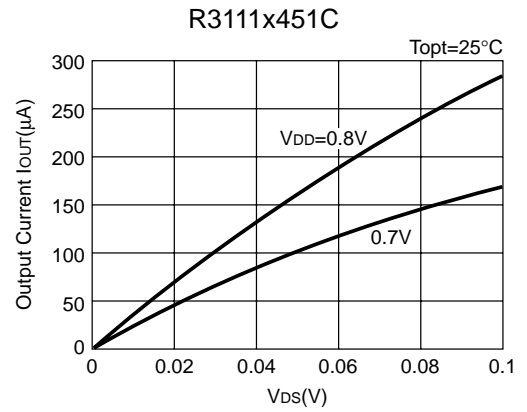
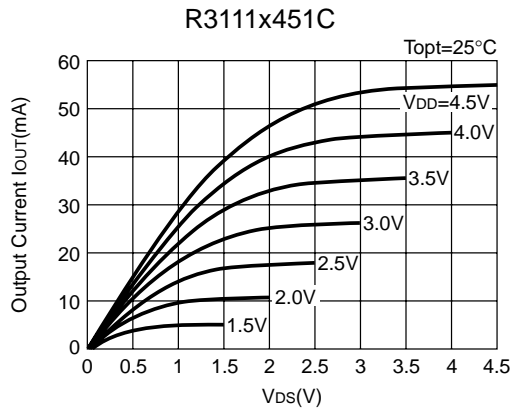

5) Nch Driver Output Current vs. Input Voltage  
**R3111x091C**

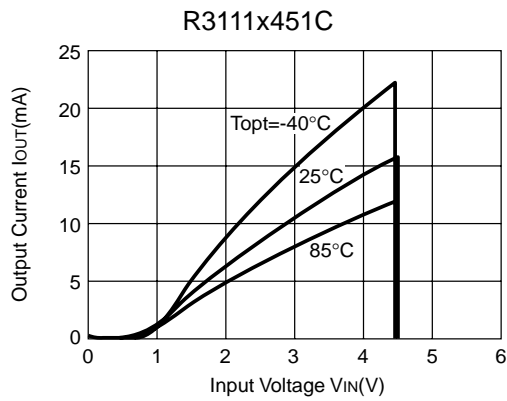
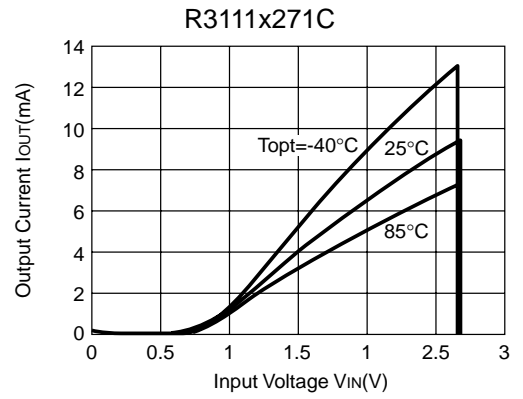
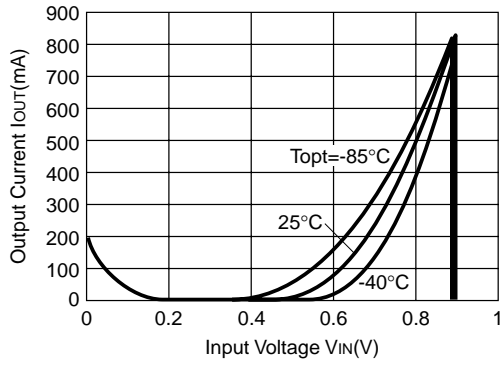

6) Pch Driver Output Current vs. Input Voltage  
R3111x091C

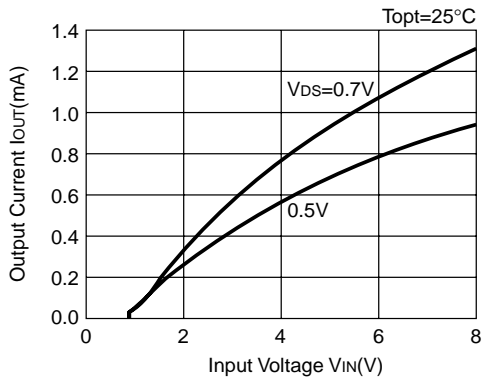

R3111x271C

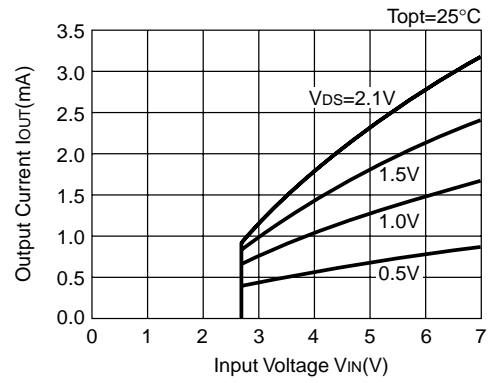

R3111x451C

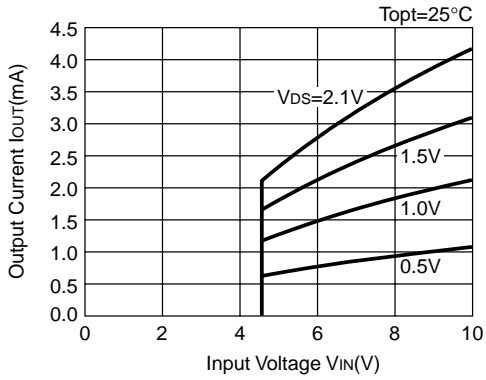

7) Output Delay Time vs. Load Capacitance  
R3111x091A

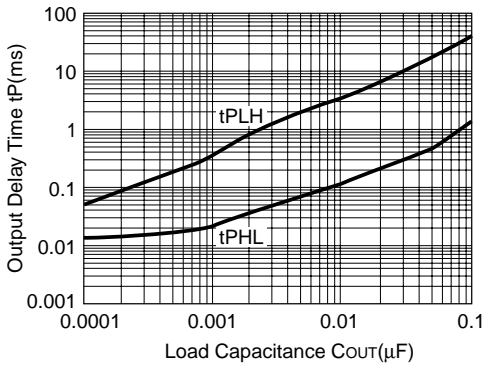

R3111x271A

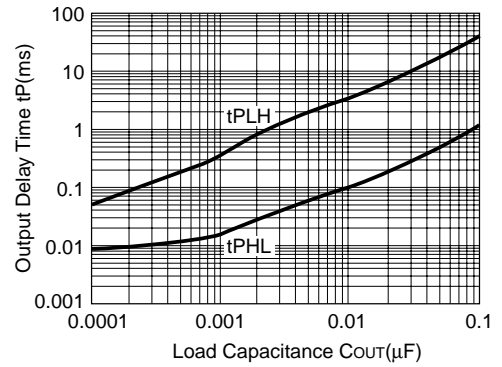



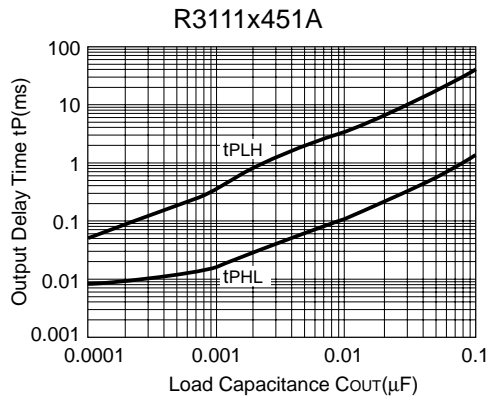

8) Output Delay Time vs. Input Pin Capacitance

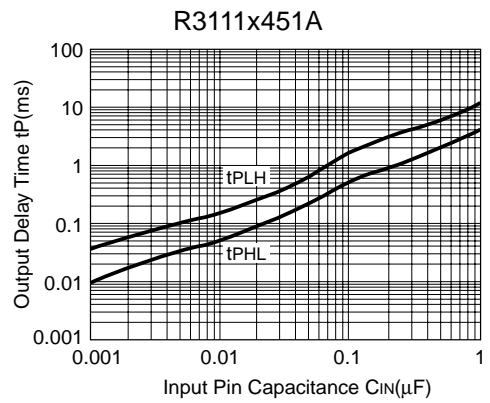
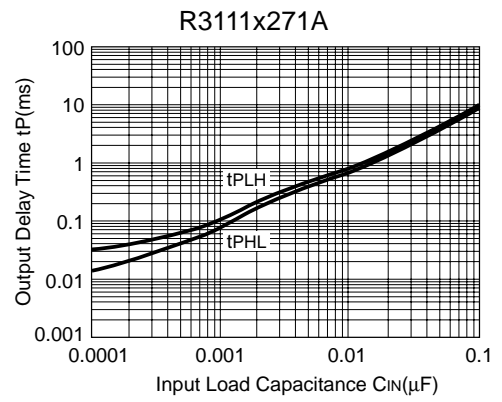
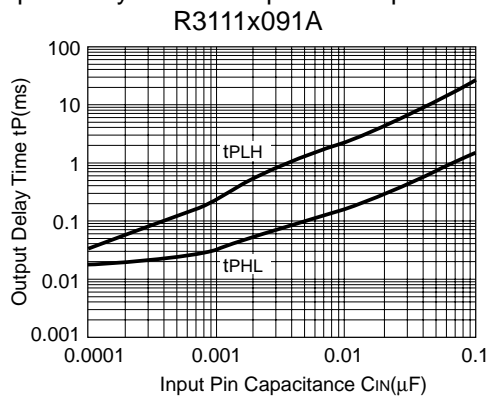

## TYPICAL APPLICATION

### R3111xxx1A CPU Reset Circuit (Nch Open Drain Output)

Case 1. Input Voltage to R3111xxx1A is equal to Input Voltage to CPU

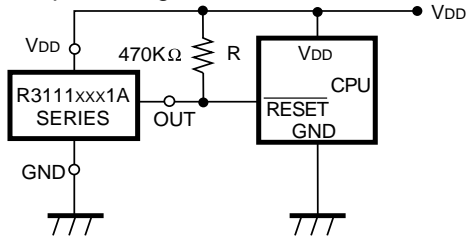

Case 2. Input Voltage to R3111xxx1A is unequal to Input Voltage to CPU

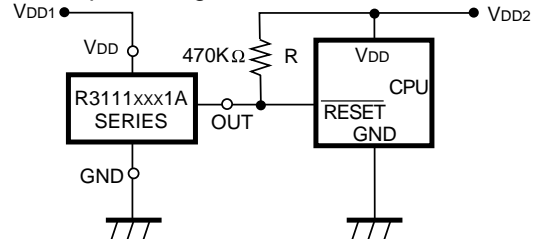

### R3111xxx1A CPU Reset Circuit CMOS Output

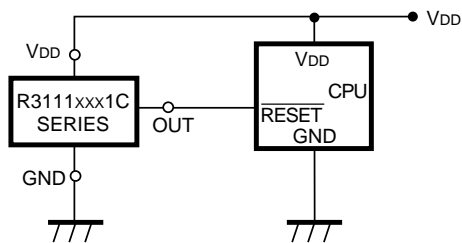

### R3111xxx1A Output Delay Time Circuit 1 (Nch Open Drain Output)

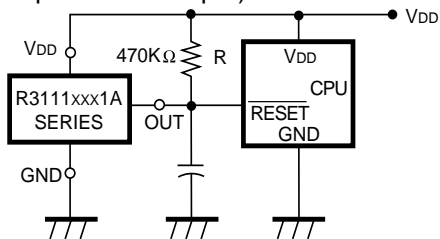

### R3111xxx1A Output Delay Time Circuit 2 (Nch Open Drain Output)

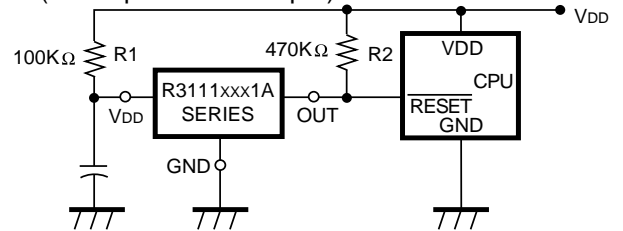

### Memory Back-up Circuit

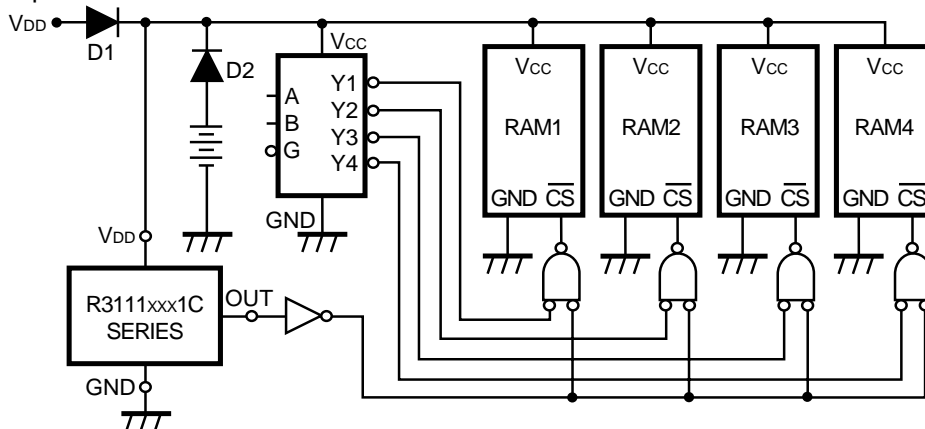

- Voltage level Indicator Circuit (lighted when the power runs out)  
(Nch Open Drain Output)

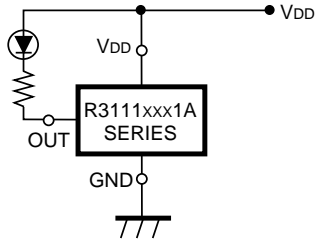

- Detector Threshold Adjustable Circuit  
(Nch Open Drain Type Output)

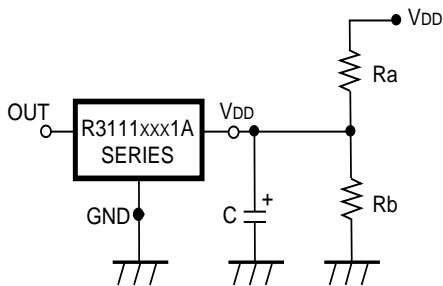

Adjusted Detector Threshold  
 $= (-V_{DET}) * (Ra + Rb) / Rb$

Hysteresis Voltage  
 $= (V_{HYS}) * (Ra + Rb) / Rb$

\*) If the value of Ra is set excessively large, voltage drop may occur caused by the supply current of IC itself, and detector threshold may vary.

- Window Comparator Circuit  
(Nch Open Drain Output)

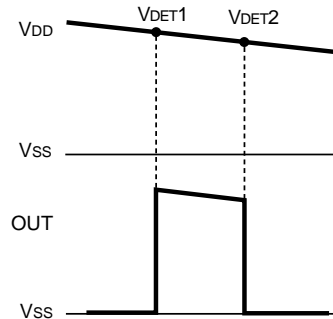
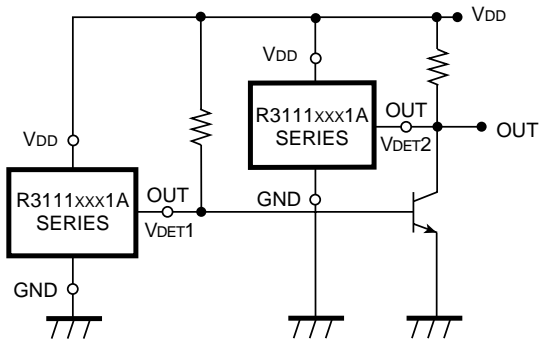

- Over-charge Preventing Circuit

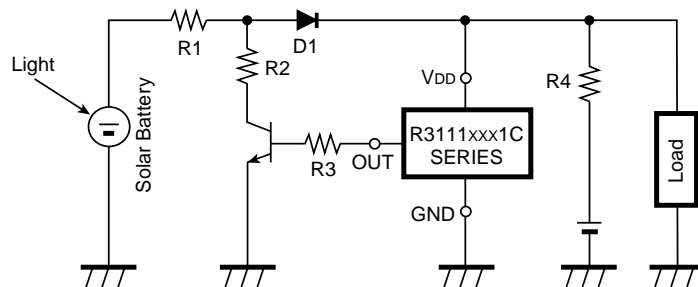

TECHNICAL NOTES

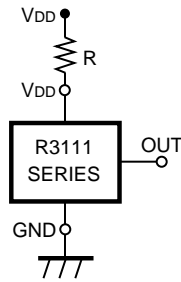

Figure 9

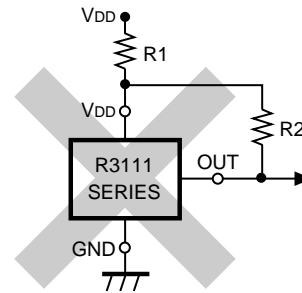

Figure 10

1. In Figure 9, When R3111xxx1C is used, and if an impedance is connected in between Voltage Supplier and the V<sub>DD</sub> Pin of R3111xxx1C Series, the operation might be unstable by through-type current at detection.  
When R3111xxx1A is used in Figure 9, if the value of R is set excessively large, voltage drop may occur caused by supply current of IC itself and Detector threshold may vary.
2. Wiring as shown in Figure 10 may cause the oscillation in both output types of R3111 Series.