

SpiceLED[™]

Like spice, its diminutive size is a stark contrast to its standout performance in terms of brightness, durability and reliability. Despite being the smallest in size yet the SpiceLED[™] packs a powerful performance and is a highly reliable design device. Its versatility enables its application in automotive appliances, key-pad illumination, hand-held devices such as PDAs, notebooks, compact back-lighting applications, consumer appliances, office equipment, audio and video equipment.



Features:

- > High brightness surface mount LED.
- > Super wide viewing angle of 160°.
- > Equivalent to 0603 package outline. Copper lead-frame construction.
- > Qualified according to JEDEC moisture sensitivity Level 2.
- > Compatible to both IR reflow soldering and TTW soldering.
- > Environmental friendly; RoHS compliance.



Applications:

- > Automotive: interior applications, eg: switches, telematics, climate control system, dashboard, etc.
- > Consumer Appliances: LCD illumination as in PDAs, LCD TV.
- > Communication: indicator and backlight in mobilephone.
- > Display: full color display video notice board.
- > Industry: white goods (eg: Oven, microwave, etc.).



Part Ordering Number	Chip Technology / Color	Viewing Angle°	Luminous Intensity @ IF = 2mA IV (mcd)
SST-SLD-L2N1-1	InGaN	160	14.00 - 35.50
• SST-SLD-L2	True Green, 525 nm		14.00 - 18.00
• SST-SLD-M1			18.00 - 22.40
• SST-SLD-M2			22.40 - 28.50
• SST-SLD-N1			28.50 - 35.50
SSB-SLD-H2K1-1	InGaN	160	3.55 - 9.00
• SSB-SLD-H2	Blue, 470 nm		3.55 - 4.50
• SSB-SLD-J1			4.50 - 5.60
• SSB-SLD-J2			5.60 - 7.20
• SSB-SLD-K1			7.20 - 9.00

NOTE

1. All part number above comes in a quantity of 3000 units per reel.
2. Other luminous intensity groups are also available upon request
3. Luminous intensity is measured with an accuracy of $\pm 11\%$.
4. Wavelength binning is carried for all units as per the wavelength-binning table. Only one wavelength group is allowed for each reel.

Wavelength Grouping

Color	Group	Wavelength distribution (nm)
SST; True Green	Full	520 - 536
	W	520 - 524
	X	524 - 528
	Y	528 - 532
	Z	532 - 536
SSB; Blue	Full	464 - 476
	W	464 - 468
	X	468 - 472
	Y	472 - 476

Dominant wavelength is measured with an accuracy of $\pm 1\text{nm}$.

Electrical Characteristics at Ta=25°C

Part Number	Min. (V)	Vf @ If = 2mA		Vf @ If = 10mA		Vr @ Ir = 10uA
		Typ. (V)	Max. (V)	Typ. (V)	Min. (V)	
SSx-SLD	2.6	2.8	3.0	3.0		5

Forward voltage, Vf is measured with an accuracy of ± 0.1 V.

Absolute Maximum Ratings

	Maximum Value	Unit
DC forward current	15	mA
Peak pulse current; (tp ≤ 10μs, Duty cycle = 0.1)	100	mA
Reverse voltage; Ir _{max} = 10μA	5	V
ESD threshold (HBM)	1000	V
LED junction temperature	110	°C
Operating temperature	-40 ... +100	°C
Storage temperature	-40 ... +100	°C
Power dissipation (at room temperature)	45	mW

Material

Material	
Lead-frame	Cu Alloy With NiPdAu Plating
Package	High Temperature Resistant Epoxy Resin

Note: product is Pb free

Intensity Vs Forward Current (True Green)

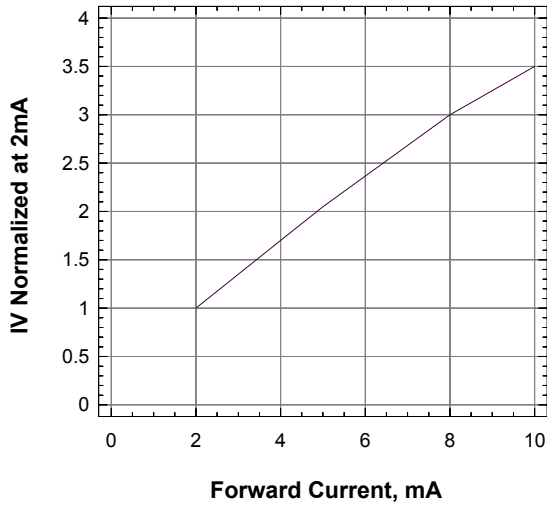

Intensity Vs Forward Current (Blue)

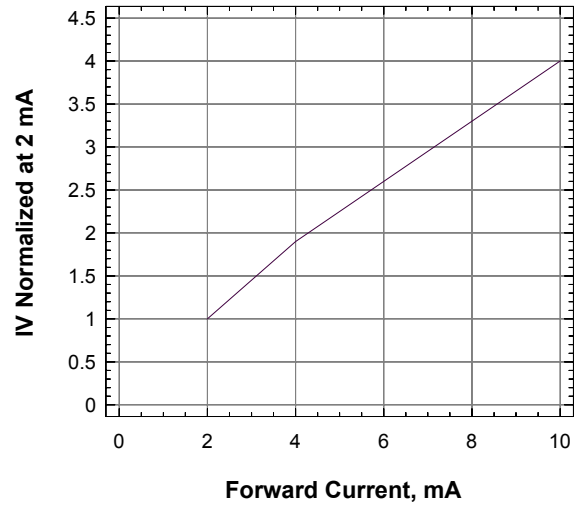

Forward Current Vs Forward Voltage

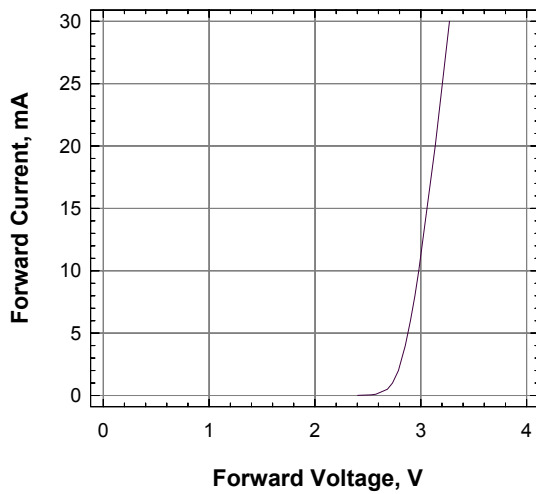

Maximum Current Vs Ambient Temperature

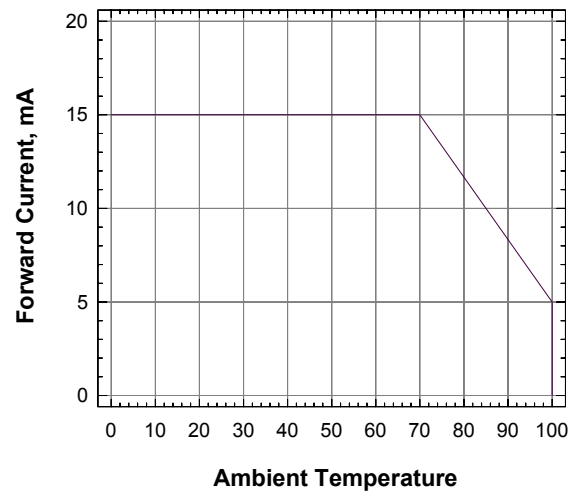

Relative Intensity Vs Wavelength

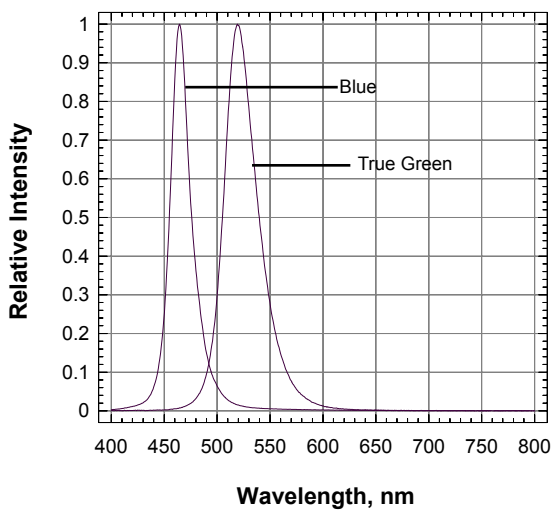

Dominant Wavelength Vs Forward Current

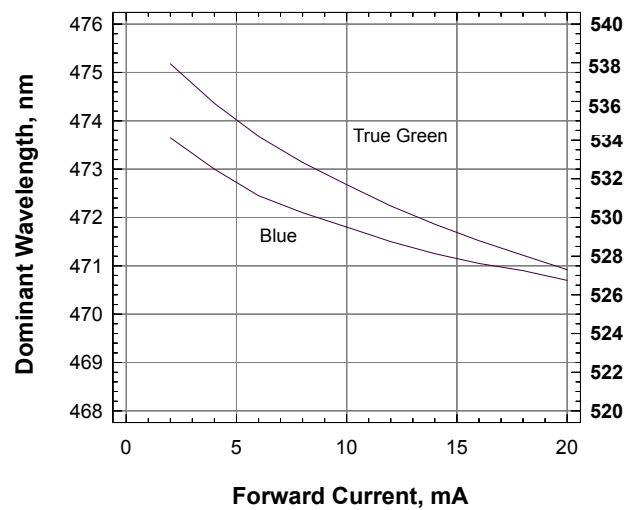

Radiation Pattern

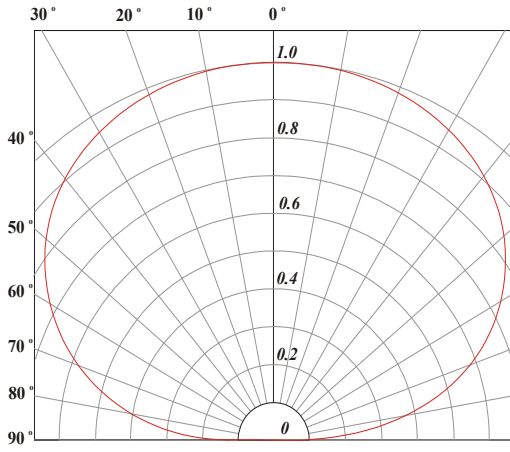

SpiceLED™ • InGaN S-Spice : SSx-SLD Package Outlines

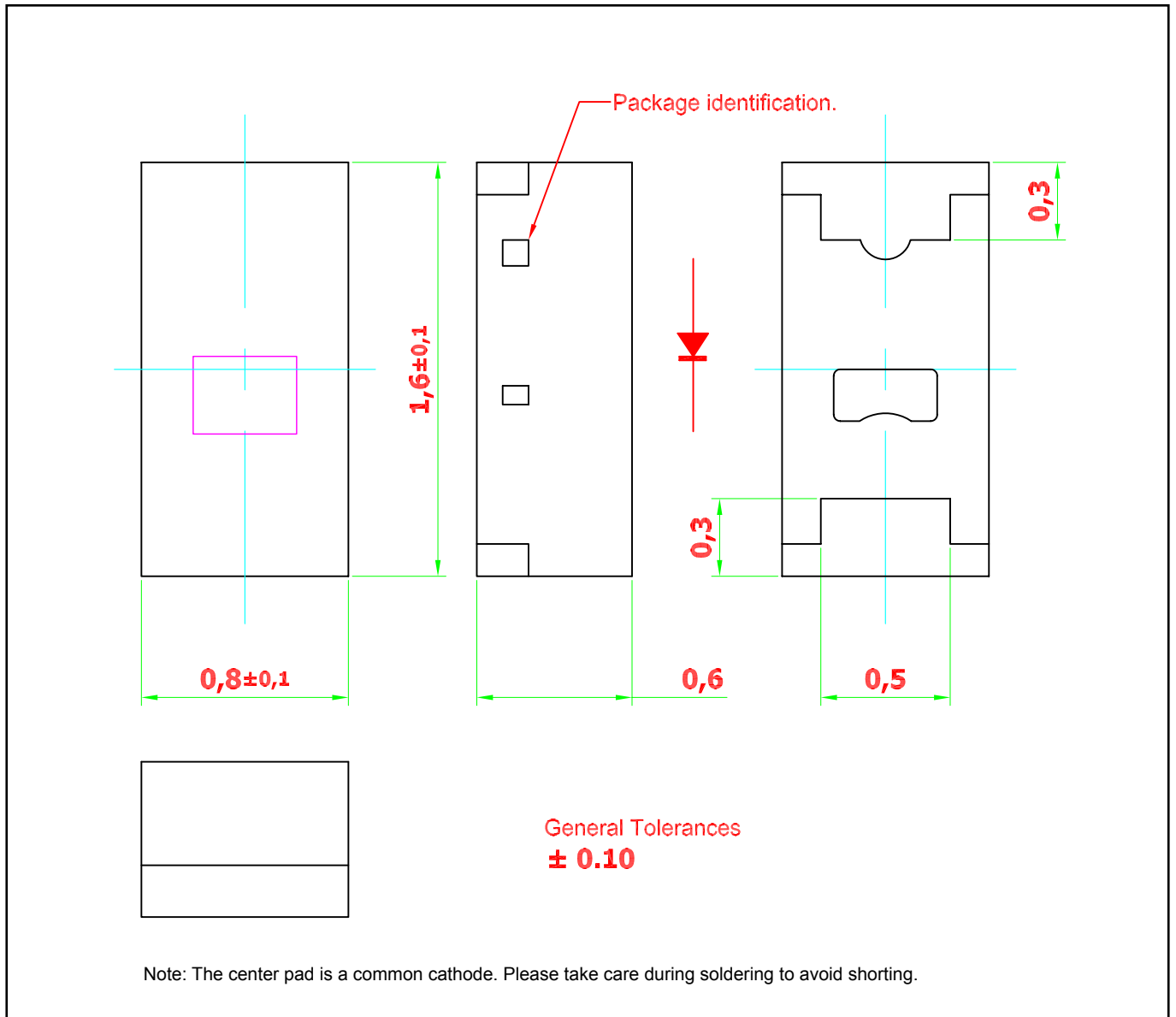

Recommended Solder Pad

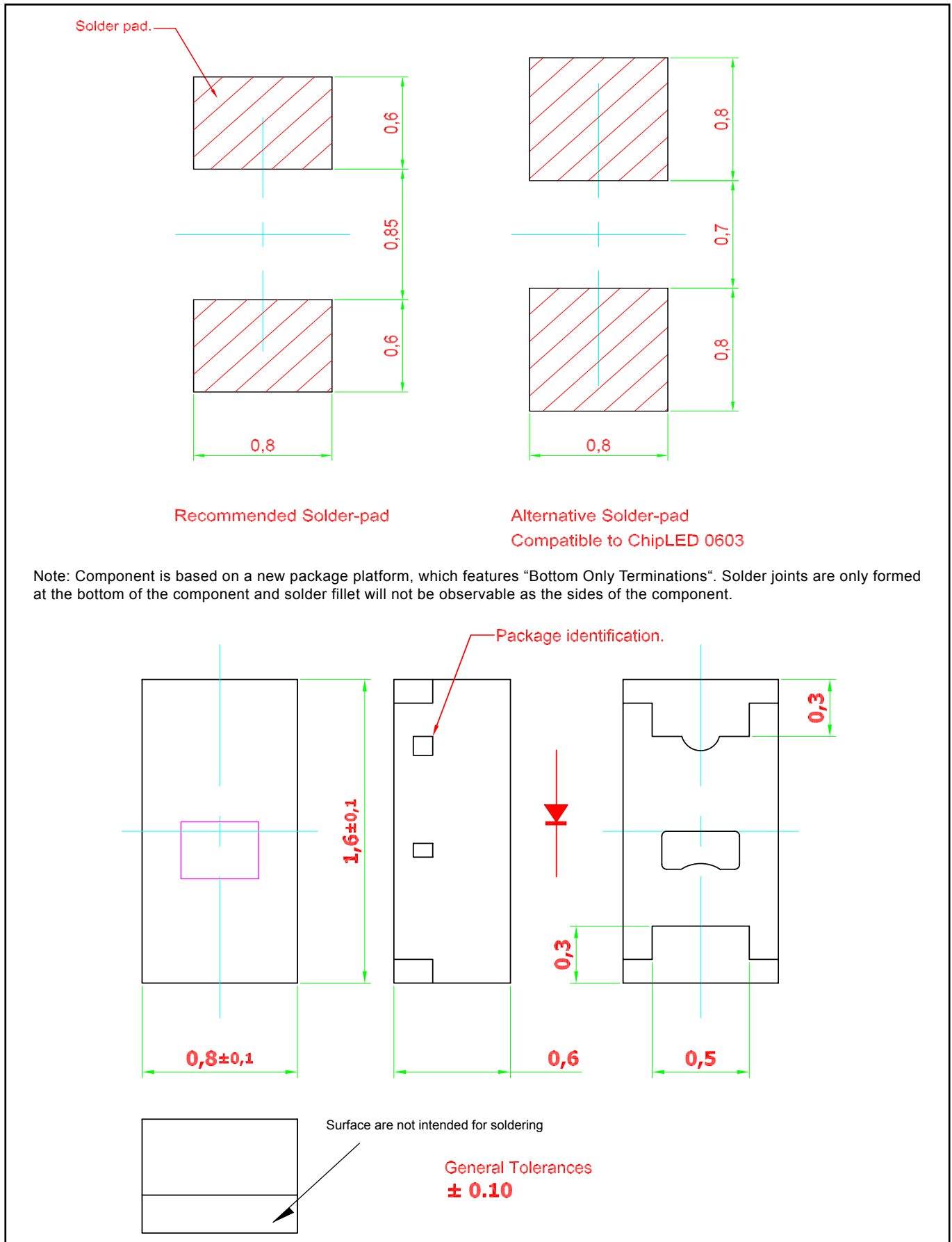

Taping and orientation

- Reels come in quantity of 3000 units.
- Reel diameter is 180 mm.

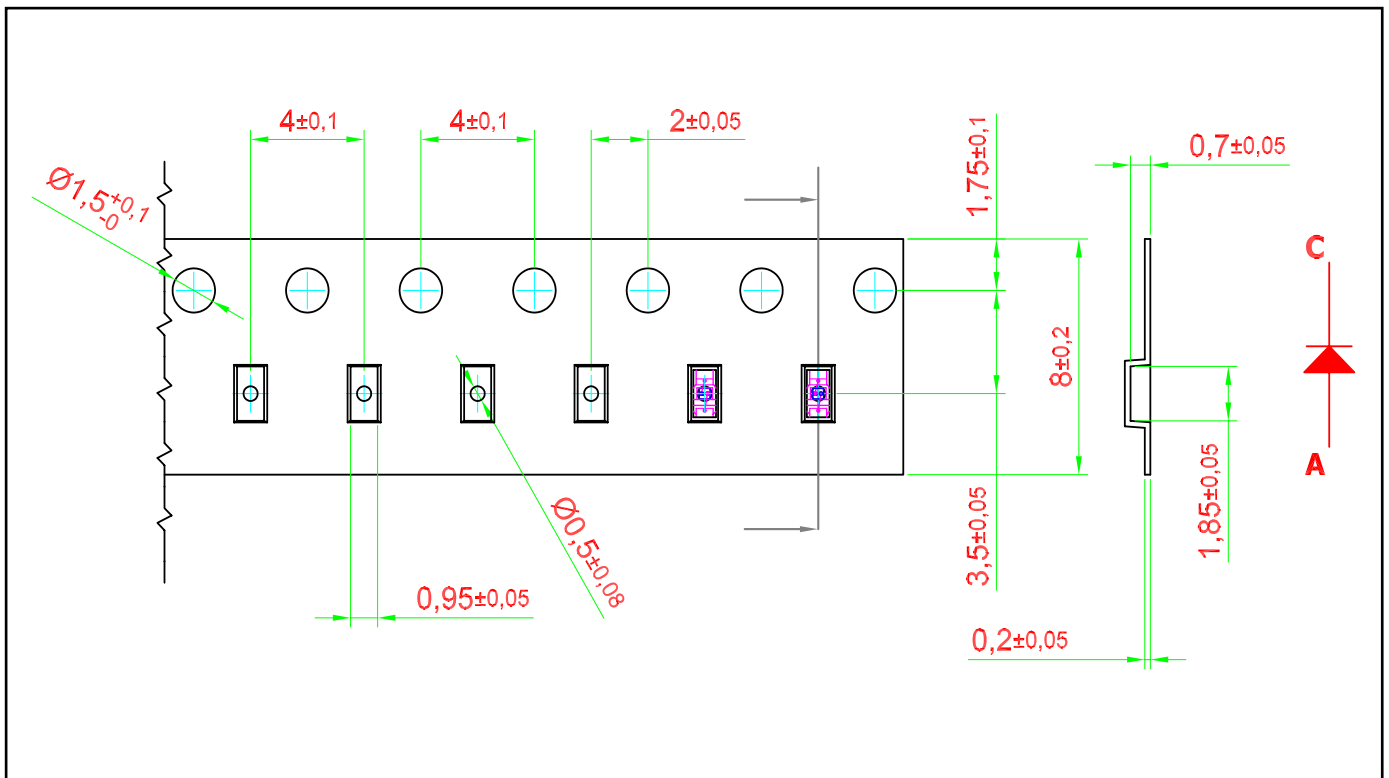

Packaging Specification

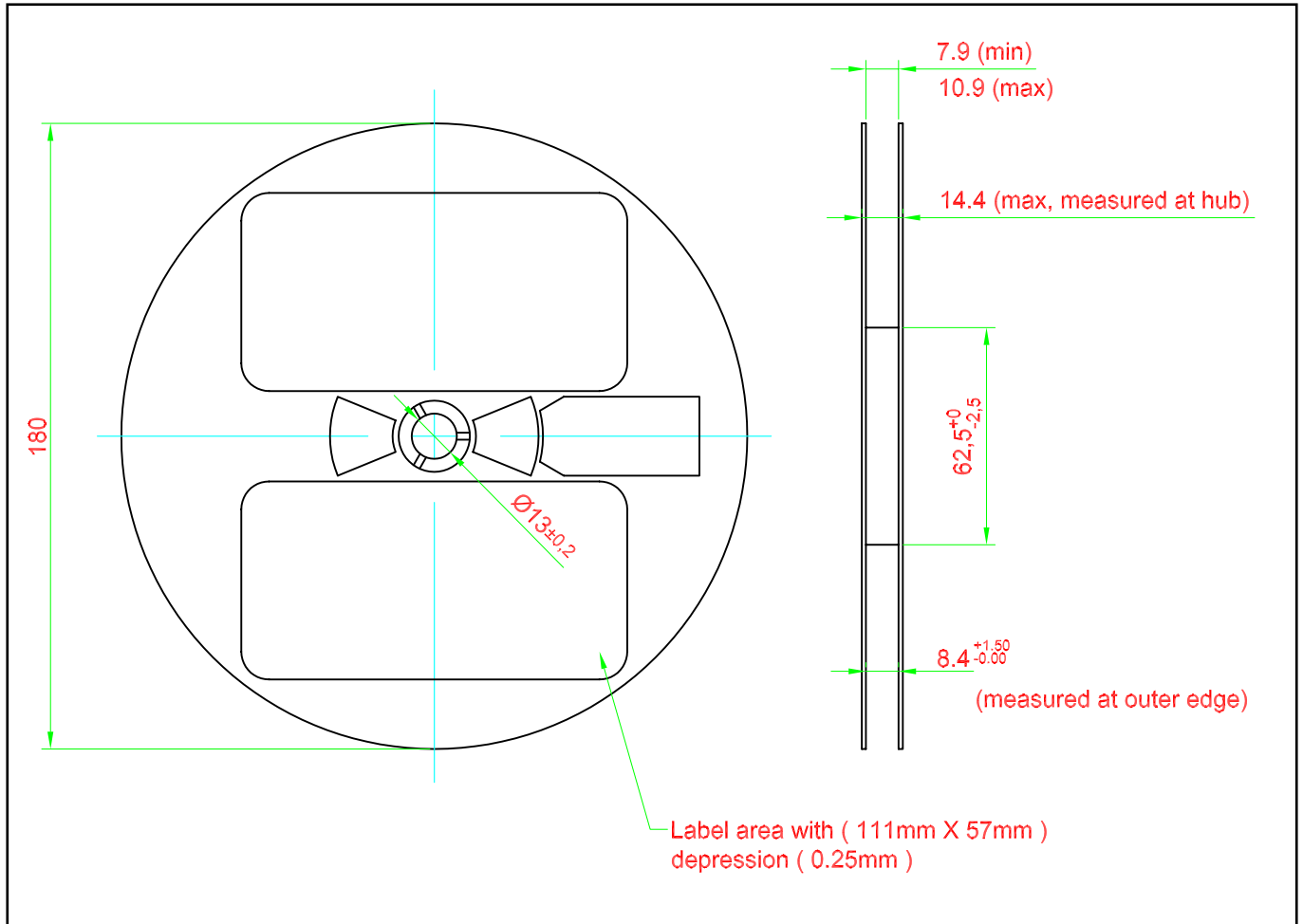

Packaging Specification

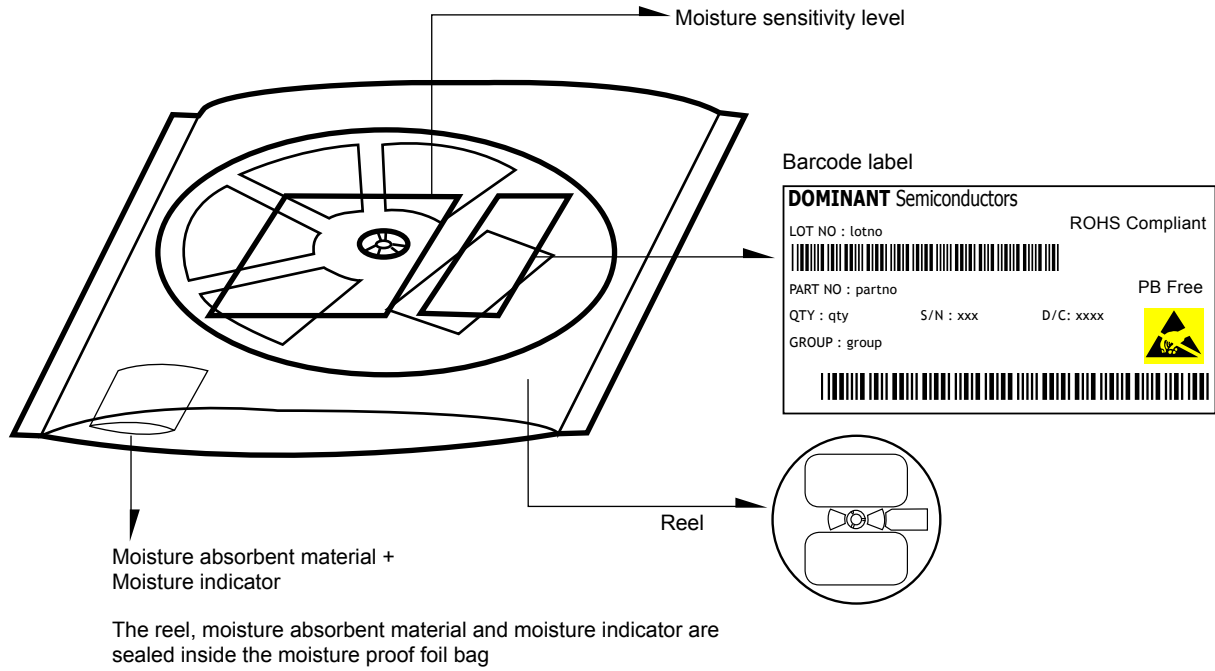

	Average 1pc SpiceLED	1 completed bag (3000pcs)
Weight (gram)	0.001	140 ± 10

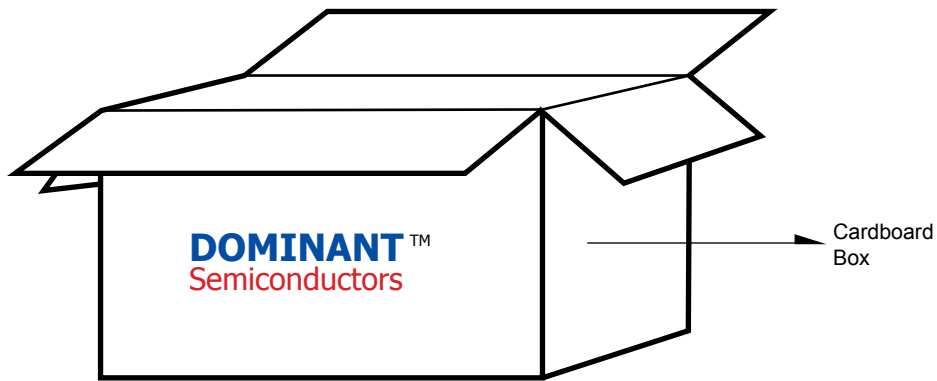

For SpiceLED™

Cardboard Box Size	Dimensions (mm)	Empty Box Weight (kg)	Reel / Box	Quantity / Box (pcs)
Small	300 x 250 x 250	0.58	15 reels MAX	45,000 MAX
Large	416 x 516 x 476	1.74	55 reels MAX	165,000 MAX

Recommended Sn-Pb IR-Reflow Soldering Profile

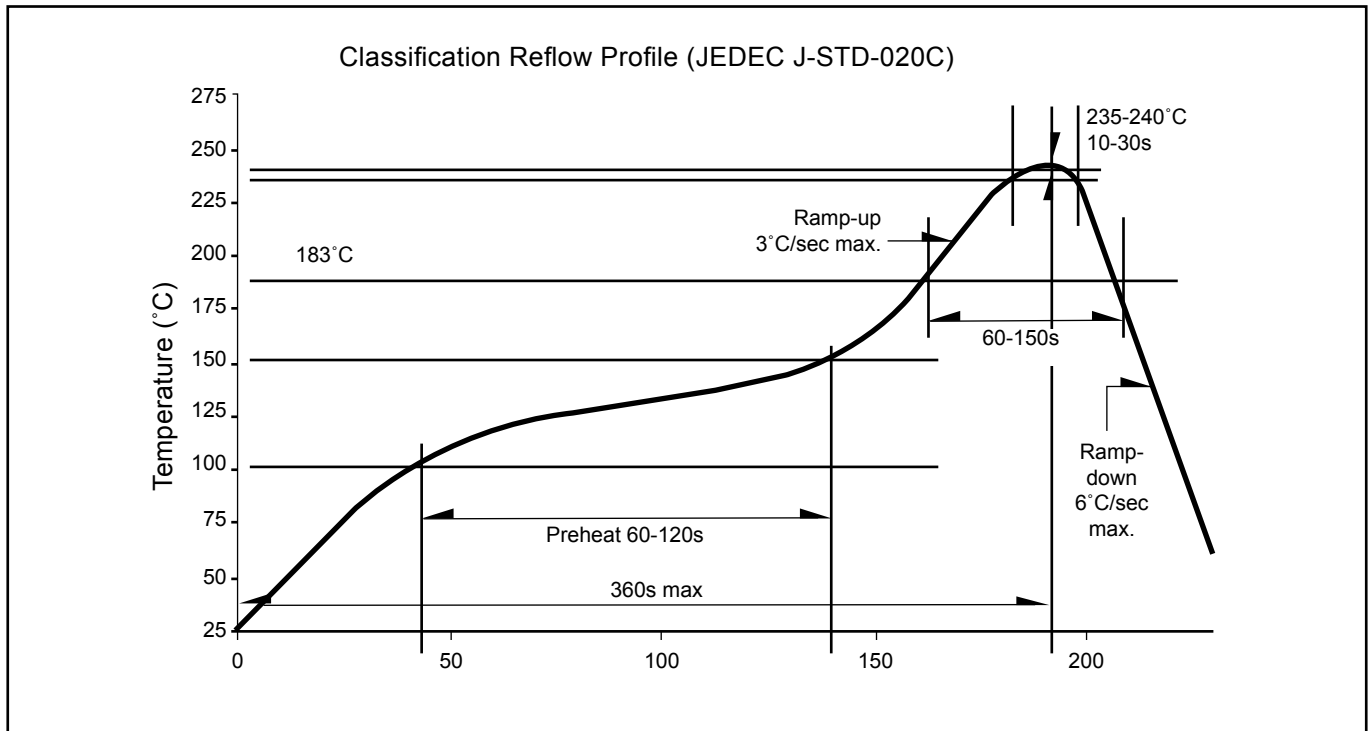

Recommended Pb-free Soldering Profile

