

**Ternary PIN Photodiode
with integrated Preamplicifier IC**

**SRP00294x
SRP00295x**

Features

- InGaAs/InP PIN photodiode with preamplifier IC
- Designed for SONET OC-48 / SDH STM-16 applications in fiber-optics communication systems
- Sensitive receiver for 2nd and 3rd optical window (1300 nm and 1550 nm)
- Suitable for bit rates up to 2.5 Gbit/s
- Module with high optical sensitivity
- Fast switching times
- Low dark current
- Excellent noise immunity
- High reverse current stability from planar structure
- Hermetically sealed TO46 package

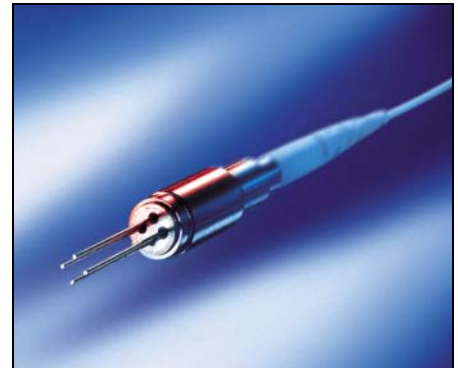

Pin Configuration

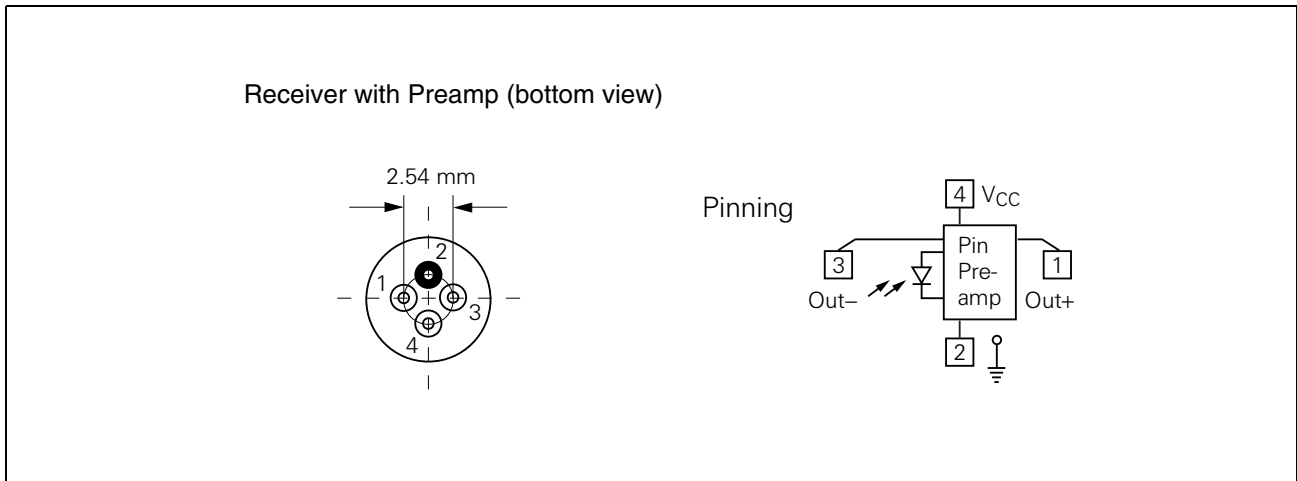

Figure 1 Receiver with Preamp

Description

The Infineon optical receiver module has been designed for use in optical networks and is suitable for bit rates up to max. 2.5 Gbit/s if used without any TIA.

The optical receiver module uses a high-speed PIN photodiode optional coupled with a hybrid low noise transimpedance amplifier (PIN-TIA). The optical receiver photodiode can be used for 1310 nm or 1550 nm optical communications.

The PIN photodiode is made of InGaAs/InP and has an active diameter of 75 μm . The function of the PIN and PIN-TIA optical receiver module is to detect input optical power, to transduce the incident radiation into current (PIN) and then to convert the current into a voltage (PIN-TIA).

The low input noise current density of the used transimpedance amplifiers in PIN-TIA's provides the optical receiver module, when used with appropriate filtering, with ample sensitivity for realizing minimum input power requirements. Designers of optical receivers can use the module in any application that benefits from integration of the photodiode and TIA into a TO coaxial package. Typical for such applications are receivers for digital crossconnects, digital loop carriers, add/drop-multiplexers and optical network units.

Last but not least the fast switching times, low dark currents and the packaging in a compact and hermetically sealed TO46 make the optical receivers usable in many other fiber optic receiver applications. One application is the use in a Compact realization of a transceiver in one module like the so called BIDI[®] (**Figure 2**).

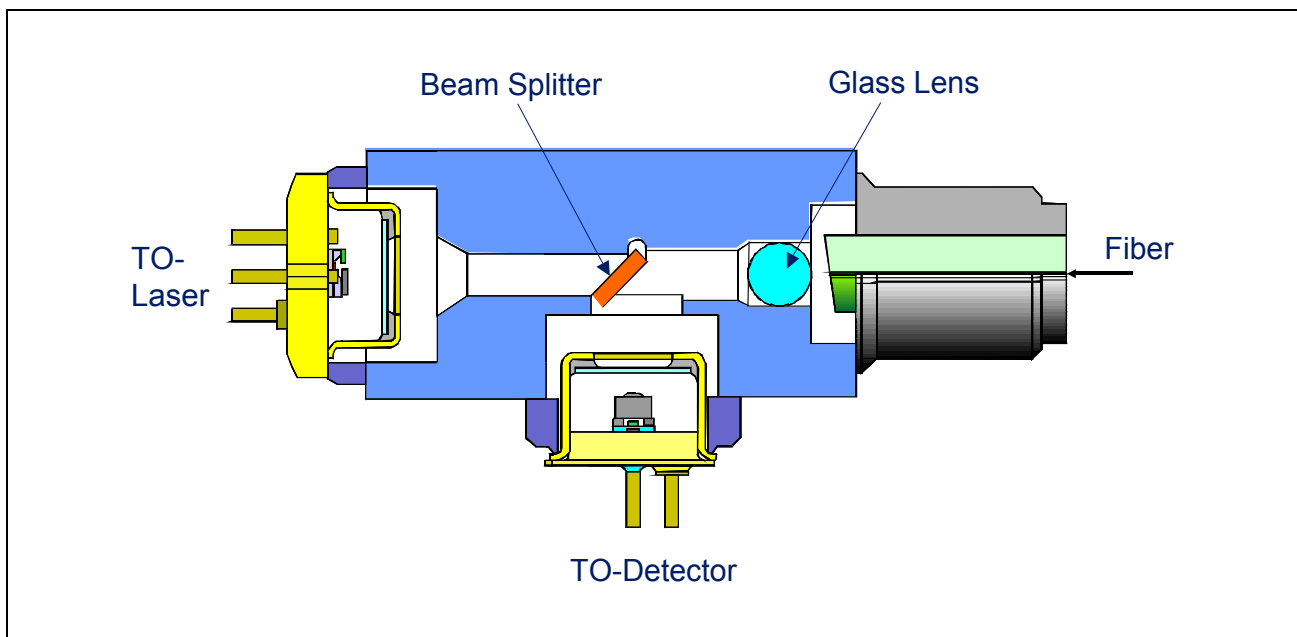

Figure 2 Compact Realization of the Transceiver in One Module

Technical Data
Absolute Maximum Ratings

Parameter	Symbol	Limit Values		Unit
		min.	max.	
Module				
Operating temperature range at case	T_C	-40	85	°C
Storage temperature range	T_{stg}	-40	85	
Soldering temperature ($t_{max} = 10$ s, 2 mm distance from bottom edge of case)	T_S		260	

Receiver Diode

Reverse Voltage	V_R		20	V
Forward Current	I_F		10	mA
Optical power into the optical port	P_{port}		1	mW

The electro-optical characteristics described in the following table are only valid for use within the specified maximum ratings or under the recommended operating conditions. Characteristics for Pin-Preamp Receivers at $T_A = 25^\circ\text{C}$, unless otherwise specified.

Preamp Characteristics

Parameter	Symbol	Limit Values			Unit
		min.	typ.	max.	

DC-Characteristics

Supply Voltage	V_{CC}	4.5	5	5.5	V
Supply Current	I_{CC}	35	47	65	mA

AC-Characteristics

Optical Sensitivity (BER $\leq 10^{-9}$, PN23)	S		-22		dBm
Linear Bandwidth (-3 dB)	BW	1200	1600		MHz
Optical overload (avg.)	P_{max}		0		dBm
Transimpedance (single ended)	R_T	9	13	17	k Ω
Output resistance	R_{out}	40	50	60	Ω
Noise current density			3		pa/ $\sqrt{\text{Hz}}$
Gain (differential)	G	11	21	34	V/mW
Return Loss, $\lambda = 1310$ nm	RL			-27	dB

Some Eye Diagrams

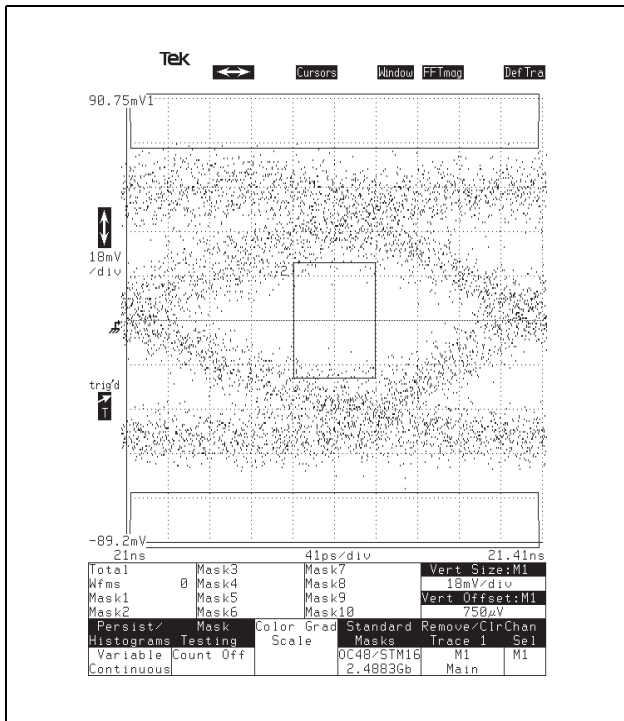

Figure 3 $P_{opt} = 5 \mu\text{W avg.}$
(OC-48/STM-16)

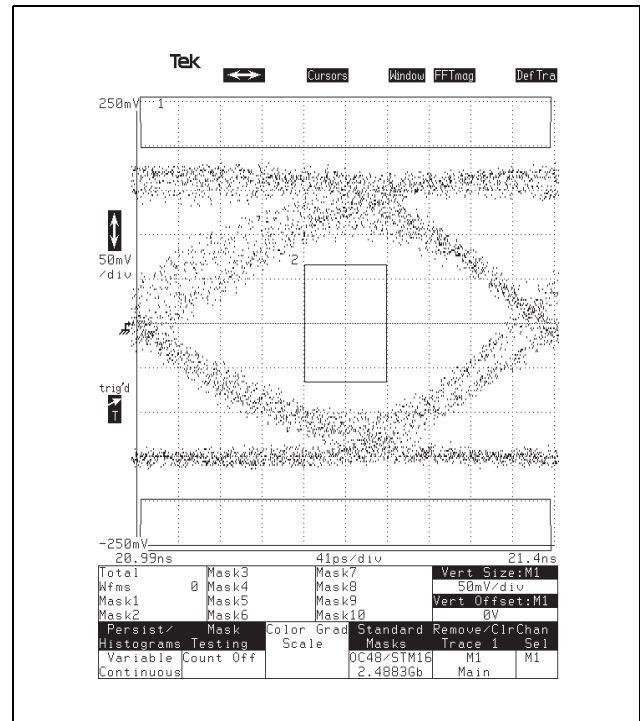

Figure 5 $P_{opt} = 10 \mu\text{W avg.}$
(OC-48/STM-16)

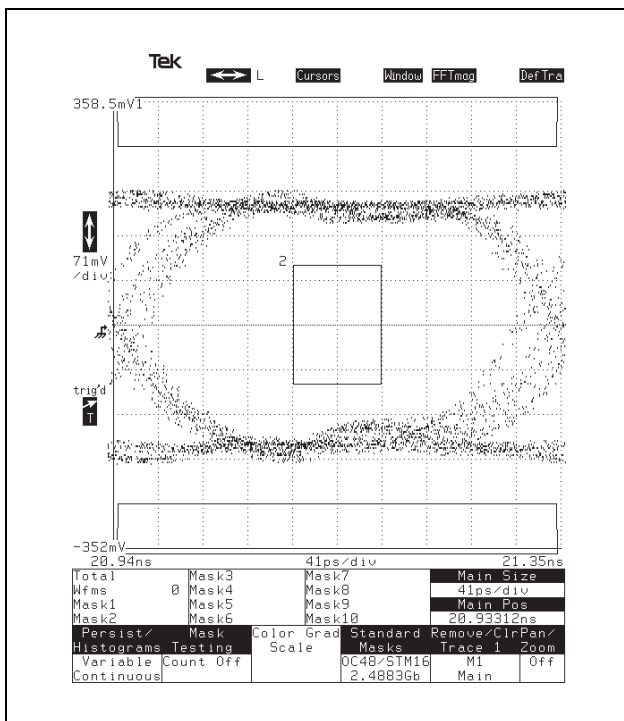

Figure 4 $P_{opt} = 100 \mu\text{W avg.}$
(OC-48/STM-16)

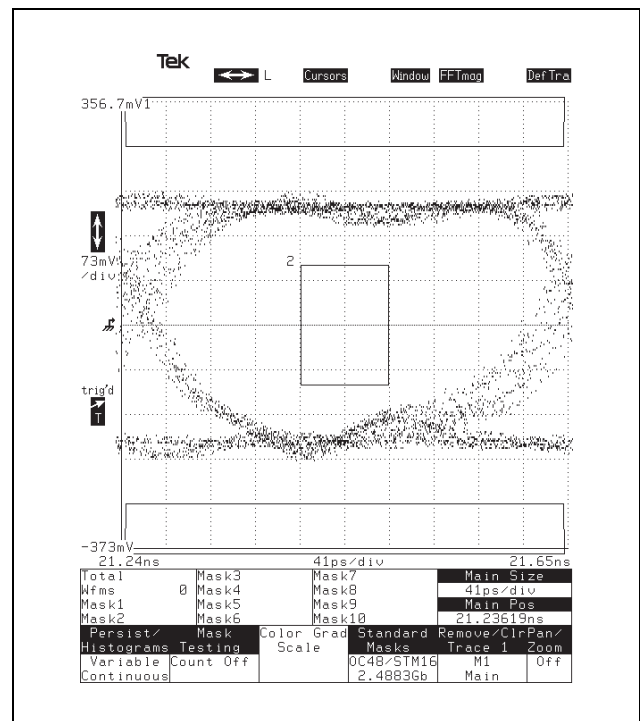

Figure 6 $P_{opt} = 500 \mu\text{W avg.}$
(OC-48/STM-16)

Fiber Data

The mechanical fiber characteristics are described in the following table.

Fiber Characteristics

Parameter	Limit Values			Unit
	min.	typ.	max.	
Mode Field Diameter		50		μm
Cladding Diameter	123	125	127	
Mode Field/Cladding Concentricity Error			1	
Cladding Non-circularity			2	%
Mode Field Non-circularity			6	
Cut off Wavelength	1270			nm
Jacket Diameter	0.8		1	mm
Bending Radius	30			
Tensile Strength Fiber Case	5			N
Length	0.8		1.2	m

Package Outlines

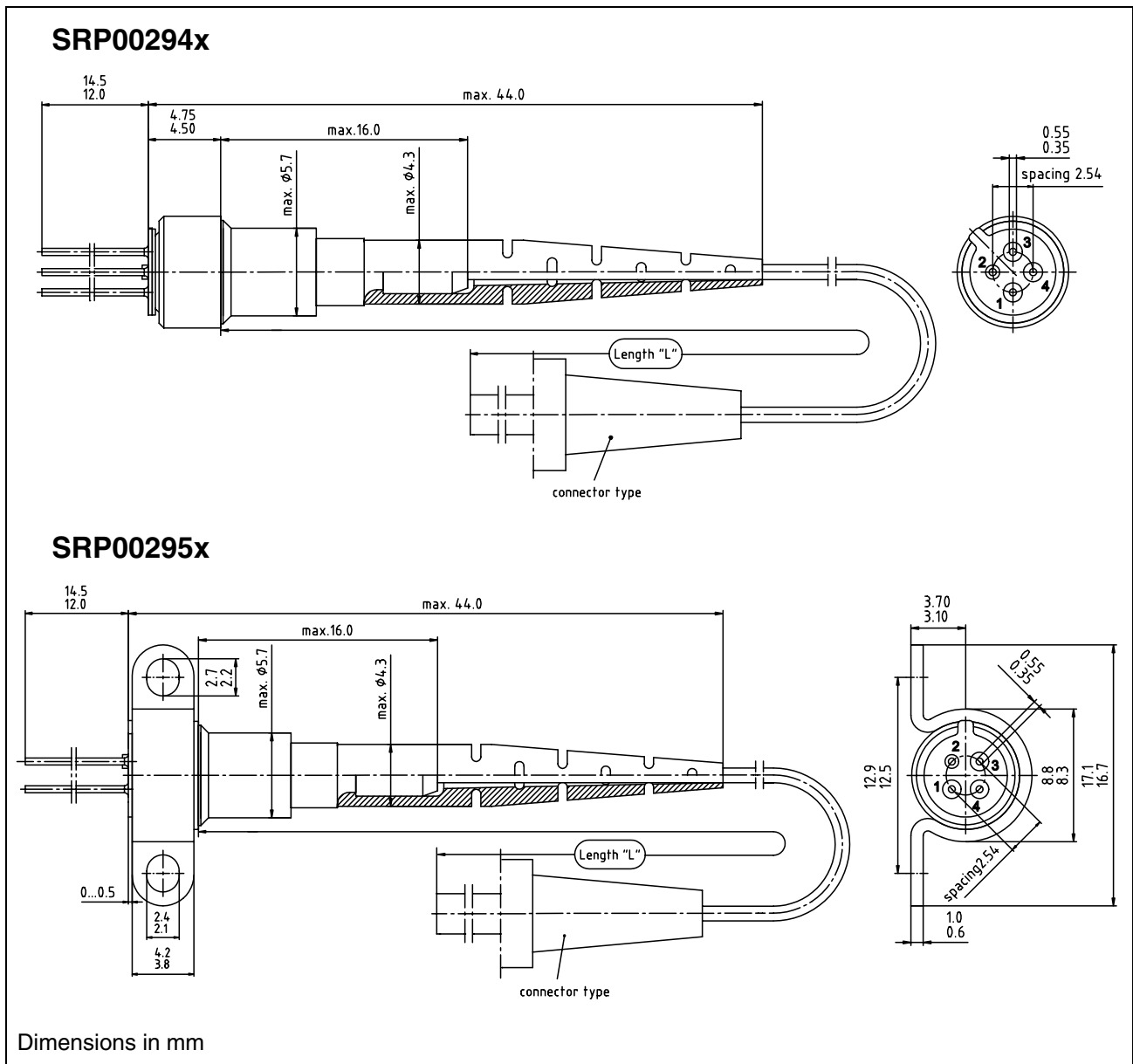

Figure 7

Flange Options

Type	Flange
SRP00294x	without
SRP00295x	with

Connector Options

Model	Type
SRP00294H SRP00295H	MM FC/PC
SRP00294G SRP00295G	SM FC/PC
SRP00294O SRP00295O	MM SC/PC 0°
SRP00294N SRP00295N	SM SC/PC 0°
SRP00294Q SRP00295Q	MM SC 8° APC
SRP00294P SRP00295P	SM SC 8° APC
SRP00294W SRP00295W	MM without connector
SRP00294Z SRP00295Z	SM without connector

Other connectors on request

SRP00294x

SRP00295x

Revision History: 2001-12-01

DS0

Previous Version:

Page	Subjects (major changes since last revision)
	Document's layout has been changed: 2002-Aug.

For questions on technology, delivery and prices please contact the Infineon Technologies Offices in Germany or the Infineon Technologies Companies and Representatives worldwide: see our webpage at <http://www.infineon.com>.

Edition 2001-12-01

**Published by Infineon Technologies AG,
St.-Martin-Strasse 53,
D-81541 München, Germany**

**© Infineon Technologies AG 2002.
All Rights Reserved.**

Attention please!

The information herein is given to describe certain components and shall not be considered as warranted characteristics.

Terms of delivery and rights to technical change reserved.

We hereby disclaim any and all warranties, including but not limited to warranties of non-infringement, regarding circuits, descriptions and charts stated herein.

Infineon Technologies is an approved CECC manufacturer.

Information

For further information on technology, delivery terms and conditions and prices please contact your nearest Infineon Technologies Office in Germany or our Infineon Technologies Representatives worldwide.

Warnings

Due to technical requirements components may contain dangerous substances. For information on the types in question please contact your nearest Infineon Technologies Office.

Infineon Technologies Components may only be used in life-support devices or systems with the express written approval of Infineon Technologies, if a failure of such components can reasonably be expected to cause the failure of that life-support device or system, or to affect the safety or effectiveness of that device or system. Life-support devices or systems are intended to be implanted in the human body, or to support and/or maintain and sustain and/or protect human life. If they fail, it is reasonable to assume that the health of the user or other persons may be endangered.