

Transmissive

- Phototransistor output.
- General-purpose model with a 3-mm-wide slot.
- PCB mounting type.
- High resolution with a 0.5-mm-wide aperture.
- Incorporating location pins to prevent mis-orientation

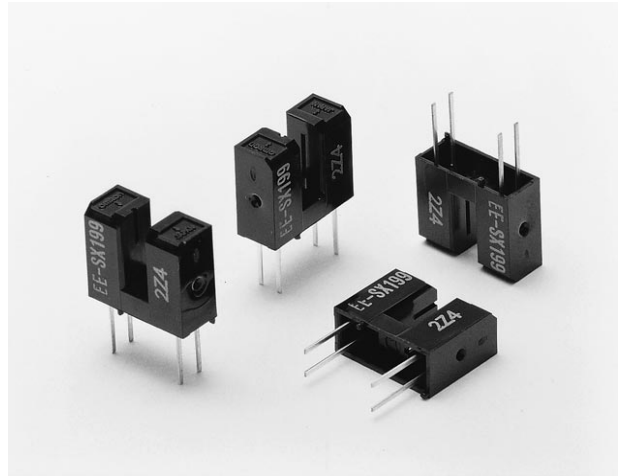

Dimensions

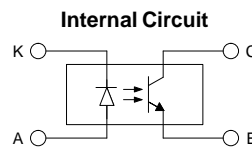
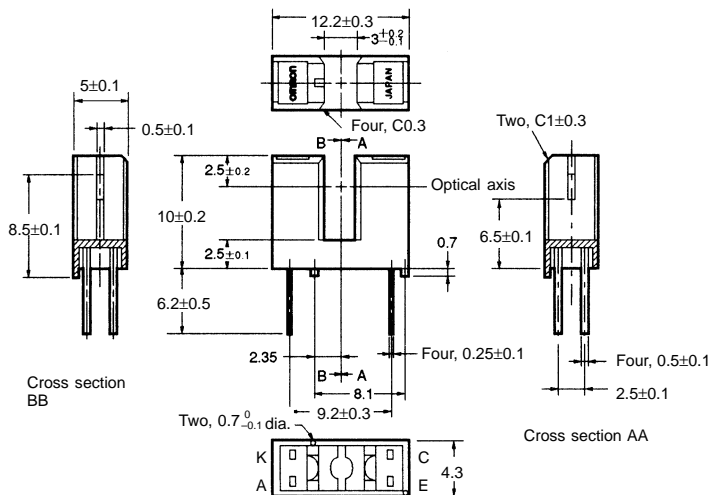

Terminal No.	Name
A	Anode
K	Cathode
C	Collector
E	Emitter

Unless otherwise specified, the tolerances are ± 0.2 .

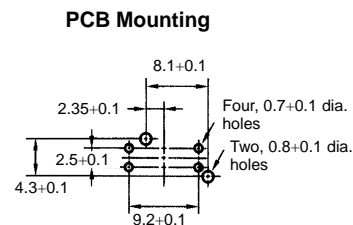

Specifications

Absolute Maximum Ratings (Ta = 25°C)

Item	Symbol	Rated value
Emitter	Forward current	I_F
	Pulse forward current	I_{FP}
	Reverse voltage	V_R
Detector	Collector-Emitter voltage	V_{CEO}
	Emitter-Collector voltage	V_{ECO}
	Collector current	I_C
	Collector dissipation	P_C
Ambient temperature	Operating	T_{opr}
	Storage	T_{stg}
	Soldering	T_{sol}

- Note:**
1. Refer to the temperature rating chart if the ambient temperature exceeds 25°C.
 2. The pulse width is 10 μ s maximum with a frequency of 100 Hz.

Electrical and Optical Characteristics (Ta = 25°C)

Item	Symbol	Value	Condition
Emitter	Forward voltage	V_F	1.2 V typ., 1.4 V max.
	Reverse current	I_R	0.01 μ A typ., 10 μ A max.
	Peak emission wavelength	λ_P	940 nm typ.
Detector	Light current	I_L	0.5 mA min., 14 mA max.
	Dark current	I_D	2 nA typ., 100 nA max.
	Leakage current	I_{LEAK}	---
	Collector-Emitter saturated voltage	$V_{CE(sat)}$	0.1 V typ., 0.4 V max.
	Peak spectral sensitivity wavelength	λ_P	850 nm typ.
Rising time	t_r	4 μ s typ.	$V_{CC} = 5$ V, $R_L = 100$ Ω , $I_L = 5$ mA
Falling time	t_f	4 μ s typ.	$V_{CC} = 5$ V, $R_L = 100$ Ω , $I_L = 5$ mA

Engineering Data

Forward Current vs. Collector Dissipation Temperature Rating

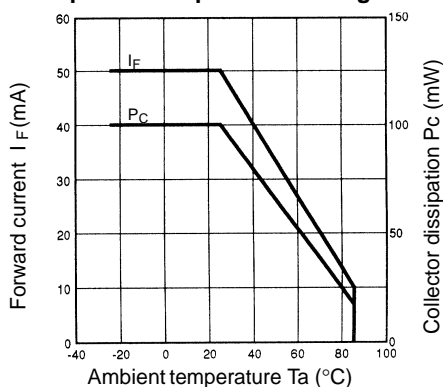

Forward Current vs. Forward Voltage Characteristics (Typical)

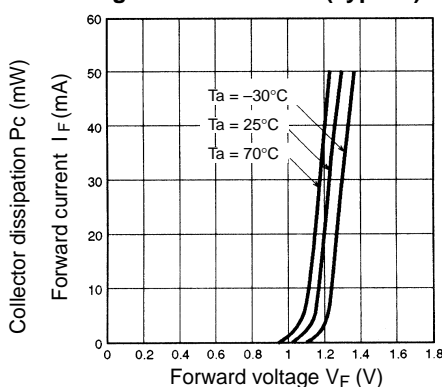

Light Current vs. Forward Current Characteristics (Typical)

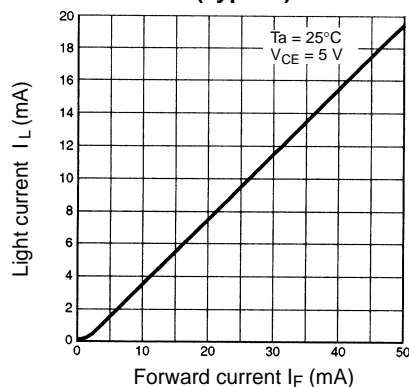

Light Current vs. Collector-Emitter Voltage Characteristics (Typical)

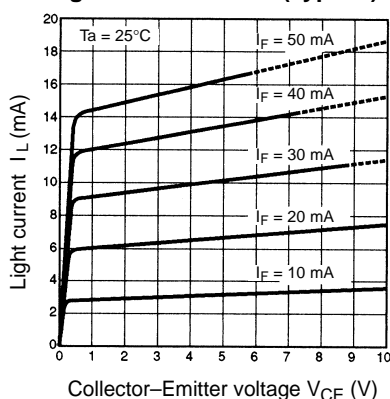

Relative Light Current vs. Ambient Temperature Characteristics (Typical)

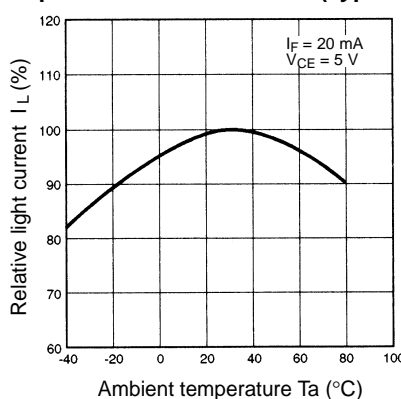

Dark Current vs. Ambient Temperature Characteristics (Typical)

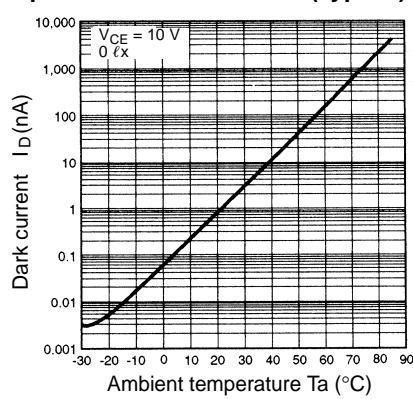

Response Time vs. Load Resistance Characteristics (Typical)

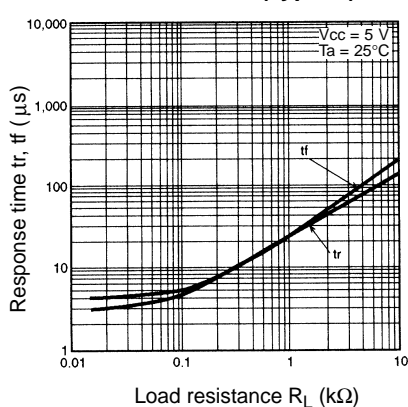

Sensing Position Characteristics (Typical)

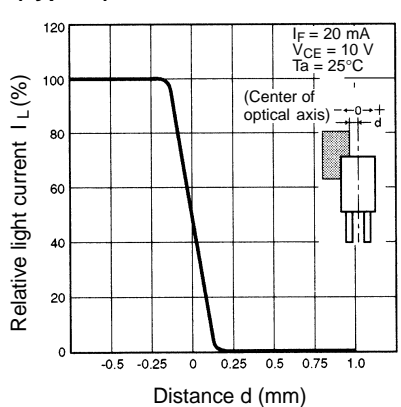

Response Time Measurement Circuit

