

# GL8□□4 series

## 2.0 × 3.1mm, Arch Type, Colored Transparency, High-luminosity LED Lamp for Indicator

### Outline Dimensions

(Unit : mm)

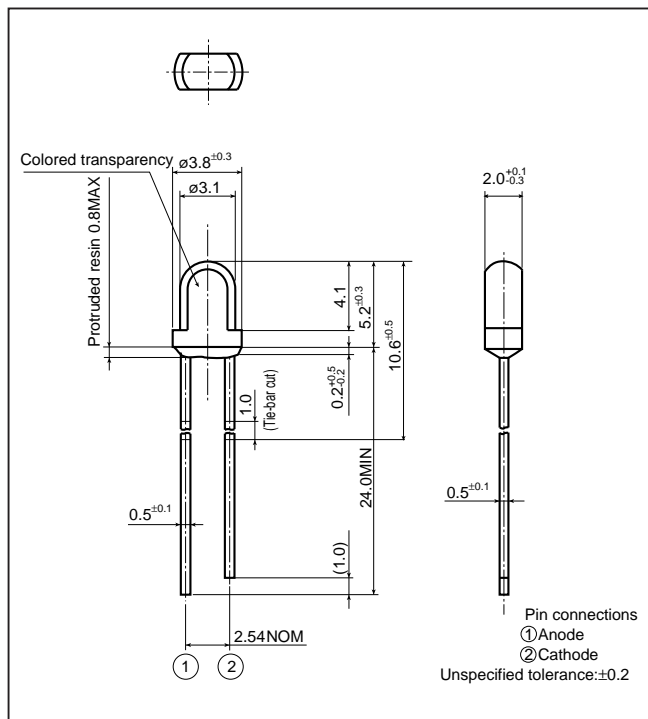

### Absolute Maximum Ratings

(T<sub>a</sub>=25°C)

Model No.	Radiation color	Radiation material	Power dissipation P (mW)	Forward current I <sub>F</sub> (mA)	Peak forward current I <sub>FM</sub> (mA)	Derating factor (mA/°C)		Reverse voltage V <sub>R</sub> (V)	Operating temperature T <sub>opr</sub> (°C)	Storage temperature T <sub>stg</sub> (°C)	Soldering temperature T <sub>sol</sub> <sup>*3</sup> (°C)
						DC	Pulse				
GL8UR4	Red(Super-luminosity)	GaAlAs on GaAlAs	75	30	50 <sup>*1</sup>	0.40	0.67	4	-25 to +85	-25 to +100	260
GL8TR4	Red(High-luminosity)	GaAlAs on GaAs	110	50	300 <sup>*2</sup>	0.67	4.00	5	-25 to +85	-25 to +100	260

\*1 Duty ratio=1/10, Pulse width=0.1ms

\*2 Duty ratio=1/16, Pulse width≤1ms

\*3 5s or less(At the position of 1.6mm or more from the bottom face of resin package)

### Electro-optical Characteristics

(T<sub>a</sub>=25°C)

Lens type	Model No.	Forward voltage V <sub>F</sub> (V)		Peak emission wavelength λ <sub>p</sub> (nm)		Luminous intensity I <sub>v</sub> (mcd)		Spectrum radiation bandwidth Δλ(nm)		Reverse current I <sub>R</sub> (μA)		Terminal capacitance C <sub>t</sub> (pF)		Page for characteristics diagrams
		TYP	MAX	TYP	I <sub>F</sub> (mA)	TYP	I <sub>F</sub> (mA)	TYP	I <sub>F</sub> (mA)	MAX	V <sub>R</sub> (V)	TYP	(MHz)	
Colored transparency	GL8UR4	1.85	2.5	660	20	150	20	20	20	100	3	25	1	→
	GL8TR4	1.75	2.2	660	20	40	20	20	20	10	4	30	1	→

(Notice) • In the absence of confirmation by device specification sheets, SHARP takes no responsibility for any defects that may occur in equipment using any SHARP devices shown in catalogs, data books, etc. Contact SHARP in order to obtain the latest device specification sheets before using any SHARP device.

(Internet) • Data for sharp's optoelectronic/power device is provided for internet.(Address <http://www.sharp.co.jp/ecg/>)

# LED Lamp Characteristics Diagrams

## UR series

Forward Current Derating Curve

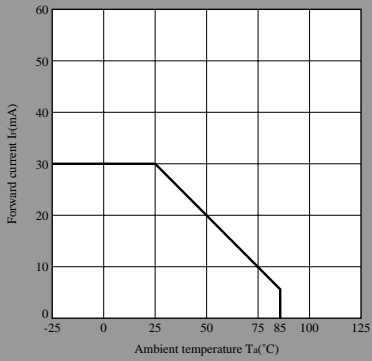

Forward Current vs. Forward Voltage(Note)

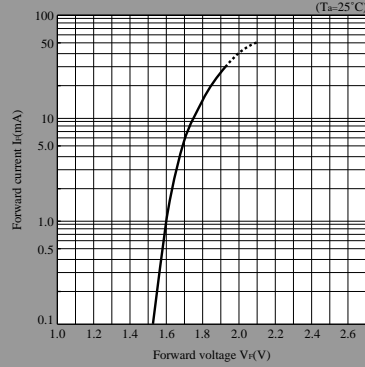

Luminous Intensity vs. Ambient Temperature(Note)

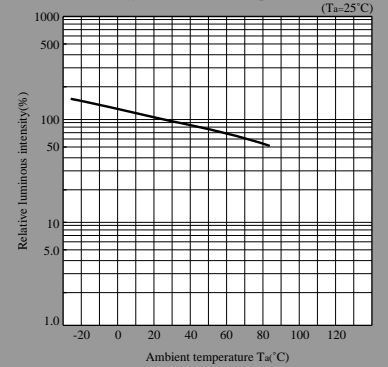

Peak Forward Current Derating Curve

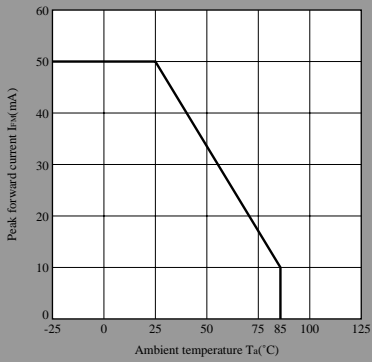

Luminous Intensity vs. Forward Current(Note)

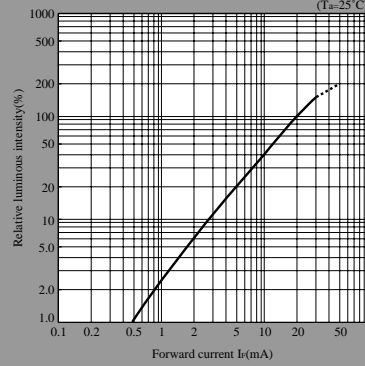

Duty Ratio vs. Peak Forward Current

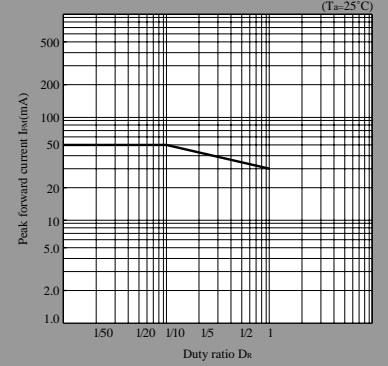

## TR series

Forward Current Derating Curve

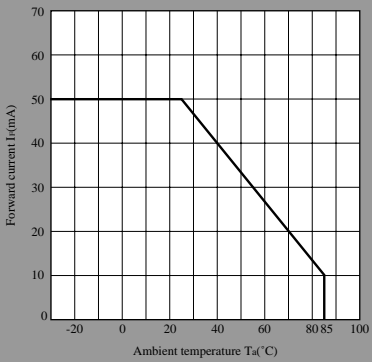

Forward Current vs. Forward Voltage(Note)

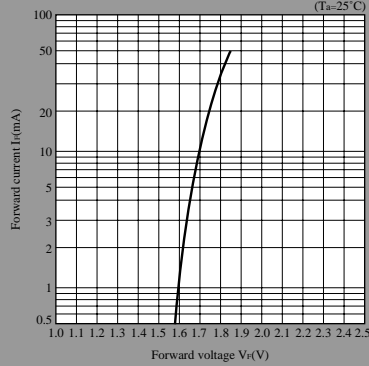

Luminous Intensity vs. Ambient Temperature(Note)

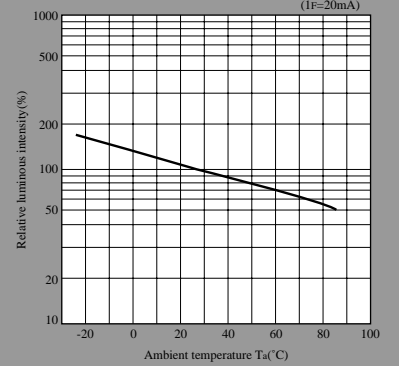

Peak Forward Current Derating Curve

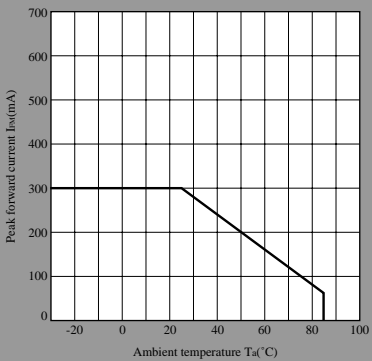

Luminous Intensity vs. Forward Current(Note)

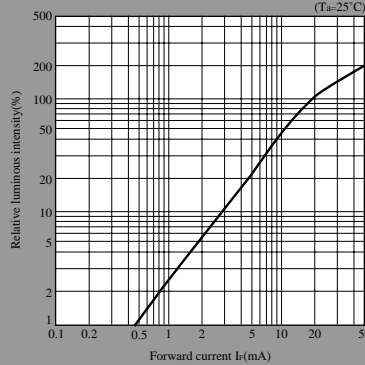

Duty Ratio vs. Peak Forward Current

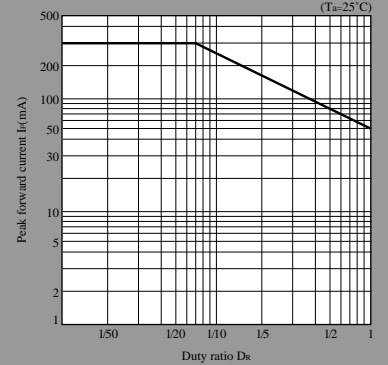

Note) Characteristics shown in diagrams are typical values. (not assurance value)

- (Notice) • In the absence of confirmation by device specification sheets, SHARP takes no responsibility for any defects that may occur in equipment using any SHARP devices shown in catalogs, data books, etc. Contact SHARP in order to obtain the latest device specification sheets before using any SHARP device.  
 (Internet) • Data for sharp's optoelectronic/power device is provided for internet.(Address <http://www.sharp.co.jp/ecg/>)