

\*\*\* 1057 Series \*\*\*

Material:

- \* Insulator: Housing – LCP UL94V-0
- \* Cover: P.P.A. (UL94V-0)
- \* Terminal: Phosphor bronze
- \* Hold-down: Phosphor bronze

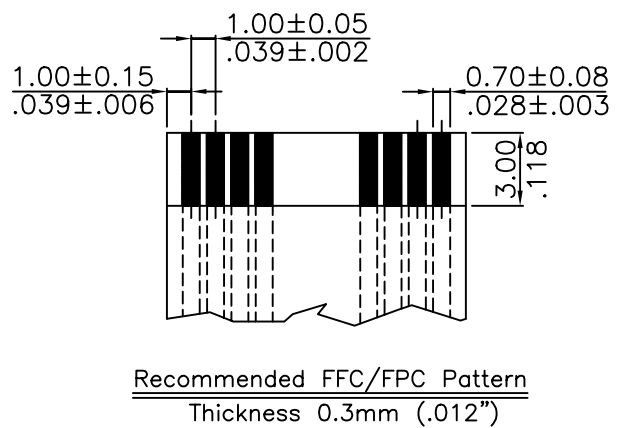
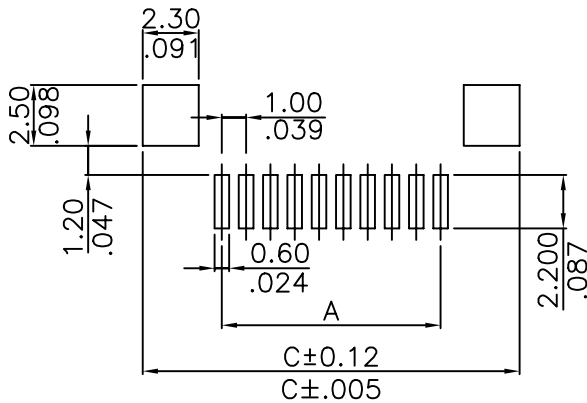
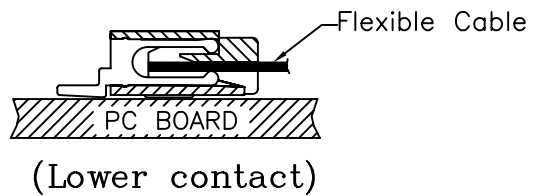
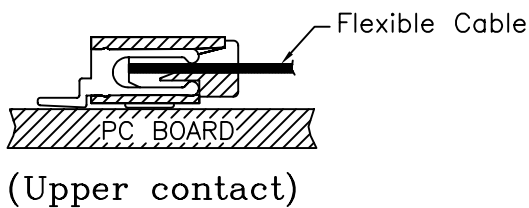
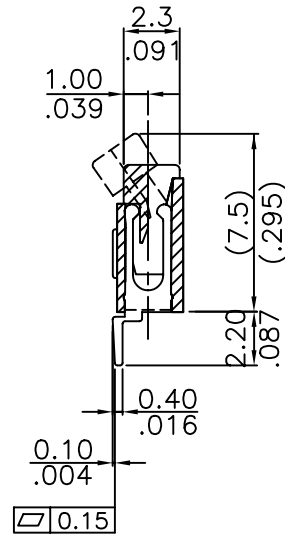
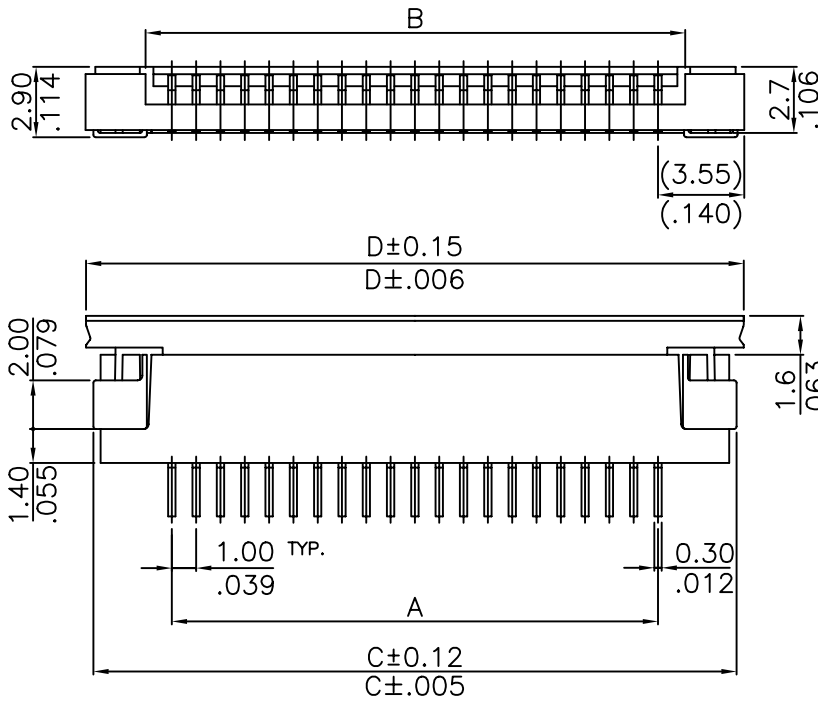

				臺灣龍傑股份有限公司 LEOCO CORPORATION		APPROVED BY:		PART NO.:					
				GENERAL TOLERANCE		CHECKED BY:		TITLE:					
				X. ±      X' ± 2'		DRAW BY:		DRAWING NO.:					
B	E000176	JENKUN			.X ± $\frac{0.30}{.012}$				1057S*****0				
A	DWG REL.				.XX ± $\frac{0.20}{.008}$				1.0mm(.039") Pitch FFC/FPC Connector				
REV.	ECO. NO.	CHG	APPD.			.XXX ± $\frac{0.10}{.004}$				DRAWING NO.:			
								UNITS mm / inch		SCALE	SIZE	SHEET	REV.
								4:1		A4	1/2	B	

Ordering Information :

[www.DataSheet.in](http://www.DataSheet.in)

$$1057S \begin{matrix} ** & * & * & * & 0 \\ \hline 1 & 2 & 3 & 4 & \end{matrix}$$

- No. of circuits
- U = Upper contact  
D = Lower contact
- Plating:  
T=Tin plated 120?" min. over 30~50?" nickel overall
- Packing:  
0 = Tube  
1 = Tape & Reel

Circuits	Dim.A	Dim.B	Dim.C	Dim.D
03	2.00(.079)	4.20(.165)	8.50(.334)	9.10(.358)
04	3.00(.118)	5.20(.205)	9.50(.374)	10.10(.394)
05	4.00(.157)	6.20(.244)	10.50(.413)	11.10(.437)
06	5.00(.197)	7.20(.283)	11.50(.453)	12.10(.476)
07	6.00(.236)	8.20(.323)	12.50(.492)	13.10(.516)
08	7.00(.276)	9.20(.362)	13.50(.531)	14.10(.555)
09	8.00(.315)	10.20(.402)	14.50(.571)	15.10(.594)
10	9.00(.354)	11.20(.441)	15.50(.610)	16.10(.634)
11	10.00(.394)	12.20(.480)	16.50(.650)	17.10(.673)
12	11.00(.433)	13.20(.520)	17.50(.689)	18.10(.713)
13	12.00(.472)	14.20(.559)	18.50(.728)	19.10(.752)
14	13.00(.512)	15.20(.598)	19.50(.768)	20.10(.791)
15	14.00(.551)	16.20(.638)	20.50(.807)	21.10(.831)
16	15.00(.591)	17.20(.677)	21.50(.846)	22.10(.870)
17	16.00(.630)	18.20(.717)	22.50(.886)	23.10(.909)
18	17.00(.669)	19.20(.756)	23.50(.925)	24.10(.949)
19	18.00(.709)	20.20(.795)	24.50(1.037)	25.10(.988)
20	19.00(.748)	21.20(.835)	25.50(1.004)	26.10(1.028)
21	20.00(.787)	22.20(.874)	26.50(1.043)	27.10(1.067)
22	21.00(.827)	23.20(.913)	27.50(1.083)	28.10(1.106)
23	22.00(.866)	24.20(.953)	28.50(1.122)	29.10(1.146)
24	23.00(.906)	25.20(.992)	29.50(1.161)	30.10(1.185)
25	24.00(.945)	26.20(1.031)	30.50(1.201)	31.10(1.224)
26	25.00(.984)	27.20(1.071)	31.50(1.240)	32.10(1.268)
27	26.00(1.024)	28.20(1.110)	32.50(1.280)	33.10(1.303)
28	27.00(1.063)	29.20(1.150)	33.50(1.319)	34.10(1.343)
29	28.00(1.102)	30.20(1.189)	34.50(1.358)	35.10(1.382)
30	29.00(1.142)	31.20(1.228)	35.50(1.398)	36.10(1.421)
31	30.00(1.181)	32.20(1.268)	36.50(1.437)	37.10(1.461)
32	31.00(1.220)	33.20(1.307)	37.50(1.476)	38.10(1.500)

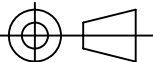
				 臺灣龍傑股份有限公司 LEOCO CORPORATION		APPROVED BY:		PART NO.: 1057S*****0				
				GENERAL TOLERANCE		CHECKED BY:		TITLE: 1.0mm(.039") Pitch FFC/FPC Connector				
				X. ±	X' ± 2'	DRAW BY:		DRAWING NO.: 105702S				
B	E000176	JENKUN		.X ± $\frac{0.30}{.012}$	.X' ±			UNITS	SCALE	SIZE	SHEET	REV.
A	DWG REL.			.XX ± $\frac{0.20}{.008}$	.XX' ±			mm	4:1	A4	2/2	B
REV.	ECO. NO.	CHG	APPD.	.XXX ± $\frac{0.10}{.004}$	.XXX' ±			inch				