

**PLEASE CHECK WWW.MOLEX.COM FOR LATEST PART INFORMATION**

**Part Number:** [0877153915](#)  
**Status:** **Active**  
**Overview:**  
**Description:** 1.00mm (.039") Pitch, PCI Express\* Connector, 280 Circuits, Nylon 4/6 Glass-filled, Black Housing, Phosphor Bronze, 0.38µm (15µ") Gold (Au) Plating, with Plastic Pegs, 3.00mm (.118") Solder tail, Lead Free

**Agency Certification**

CSA LR19980

**General**

Product Family Edge Card Connectors  
 Series 87715  
 Component Type Edgecard to PCB  
 Overview pci\_express\_card\_edge\_connector  
 Product Name PCI Express\*

**Physical**

Circuits (Loaded) 280  
 Circuits (maximum) 280  
 Circuits Detail All Signal  
 Durability (mating cycles max) 50  
 Entry Angle Vertical (Top Entry)  
 Flammability 94V-0  
 Keying to Mating Part Yes  
 Material - Plating Mating Gold  
 Material - Plating Termination Tin  
 PC Tail Length (in) 0.118 In  
 PC Tail Length (mm) 3.00 mm  
 PCB Locator Yes  
 PCB Retention Yes  
 PCB Thickness Recommended (in) 0.093 In  
 PCB Thickness Recommended (mm) 2.40 mm  
 Packaging Type Tray  
 Pitch - Mating Interface (in) 0.039 In  
 Pitch - Mating Interface (mm) 1.00 mm  
 Pitch - Term. Interface (in) 0.039 In  
 Pitch - Term. Interface (mm) 1.00 mm  
 Plating min: Mating (µin) 15  
 Plating min: Mating (µm) 0.38  
 Polarized to Mating Part Yes  
 Temperature Range - Operating -55°C to +85°C  
 Termination Interface: Style Through Hole

**Electrical**

Current - Maximum per Contact 1.1A  
 Voltage - Maximum 50V AC (RMS)/DC

**Material Info**

**Reference - Drawing Numbers**

Packaging Specification PK-87715-206  
 Product Specification PS-87715-206  
 Sales Drawing SD-87715-206  
 Test Summary TS-87715-206

\* PCI Express is a registered trademark of PCI-SIG®

**EU RoHS**

**ELV and RoHS  
Compliant**

**REACH SVHC**

Not Reviewed

**Halogen-Free**

**Status**

**Not Reviewed**

**China RoHS**



**Need more information on product  
environmental compliance?**

Email [productcompliance@molex.com](mailto:productcompliance@molex.com)  
 For a multiple part number RoHS Certificate of Compliance, [click here](#)

Please visit the [Contact Us](#) section for any non-product compliance questions.

**Search Parts in this Series**

87715Series

**Mates With**

PCI Express Card

This document was generated on 06/04/2010

**PLEASE CHECK [WWW.MOLEX.COM](http://WWW.MOLEX.COM) FOR LATEST PART INFORMATION**

7 6 5 4 3 2 1

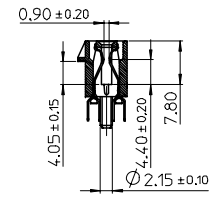
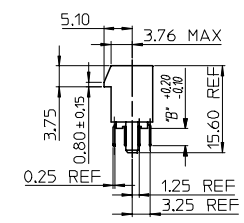
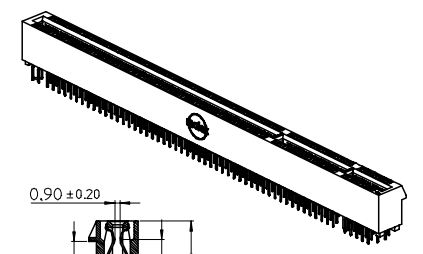
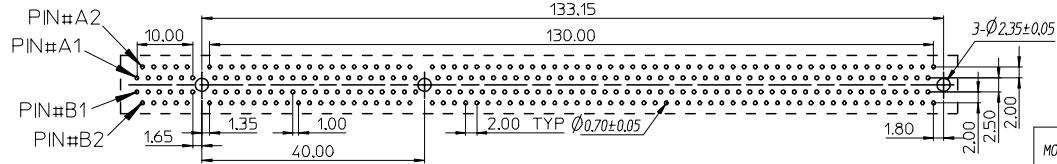
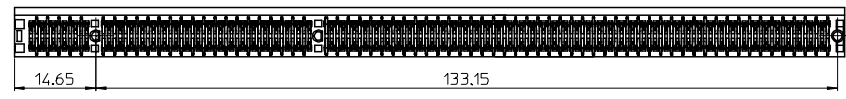
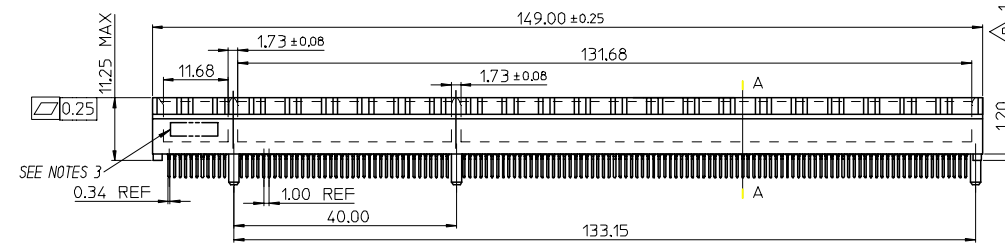
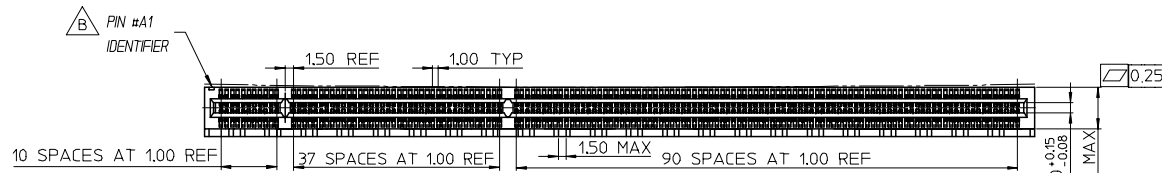

SECTION A-A

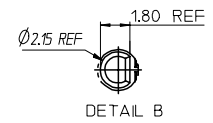

- NOTES:  
 1.MATERIALS:  
 1-1.HOUSING:SEE TABLE GLASS FIBER FILLED UL94V-0  
 COLOR:SEE TABLE  
 1-2.CONTACT:SEE TABLE  
 2.PLATING:  
 2-1.CONTACT AREA:SEE TABLE  
 2-2.SOLDER TAIL:SEE TABLE  
 2-3.UNDER PLATING:SEE TABLE  
 3.DATE CODE:TO BE PRINTED  
 4.PRODUCT SPECIFICATION REFER TO PS-87715-200  
 5.PACKAGE SPECIFICATION REFER TO PK-87715-206  
 6.TEST SUMMARY:REFER TO TS-87715-206  
 7.LEAD FREE AND ROHS COMPLIANT.

MOLEX PIN	CIRCUIT SIZE	HOUSING MATERIAL	HOUSING COLOR	TERMINAL MATERIAL	CONTACT PLATING	SOLDERTAIL PLATING	DIMB*
87715-3914	280	NYLON 46	BLACK	PHOSPHOR BRONZE	GOLD FLASH	100 MICRORINCH TIN OVER 50 MICRORINCH NICKEL OVERALL	3.00
87715-3915	280	NYLON 46	BLACK	PHOSPHOR BRONZE	15 MICRORINCH	100 MICRORINCH TIN OVER 50 MICRORINCH NICKEL OVERALL	3.00
87715-3916	280	NYLON 46	BLACK	PHOSPHOR BRONZE	30 MICRORINCH	100 MICRORINCH TIN OVER 50 MICRORINCH NICKEL OVERALL	3.00
87715-3917	280	NYLON 46	BLACK	PHOSPHOR BRONZE	GOLD FLASH	100 MICRORINCH TIN OVER 50 MICRORINCH NICKEL OVERALL	2.54
87715-3918	280	NYLON 46	BLACK	PHOSPHOR BRONZE	15 MICRORINCH	100 MICRORINCH TIN OVER 50 MICRORINCH NICKEL OVERALL	2.54
87715-3919	280	NYLON 46	BLACK	PHOSPHOR BRONZE	30 MICRORINCH	100 MICRORINCH TIN OVER 50 MICRORINCH NICKEL OVERALL	2.54

EWR 2006-0005 & 2006-0019 2005-0094 EC NO: SH2006-0100 DRWN:ALL IN 2006/05/15 CHKD: 2006/05/15 APPR:WWSCHANG 2006/05/16	QUALITY SYMBOLS ▽=0 ▽=0	GENERAL TOLERANCES (UNLESS SPECIFIED)		DIMENSION STYLE MM ONLY		SCALE	DESIGN UNITS	THIRD ANGLE PROJECTION		
			mm	INCH	DRAWN BY	DATE	TITLE	1.0 EDGE CARD 280 CKT VERTICAL DIP CONNECTOR (LEAD FREE VERSION)		
		4 PLACES	± ---	± ---	TOM	2005/03/22	MOLEX INCORPORATED			
		3 PLACES	± ---	± ---	CHECKED BY	DATE		SHEET NO.		
2 PLACES	± 0.25	± ---	ALL IN	2005/03/22	1 OF 2					
1 PLACE	± 0.25	± ---	APPROVED BY	DATE	THIS DRAWING CONTAINS INFORMATION THAT IS PROPRIETARY TO MOLEX INCORPORATED AND SHOULD NOT BE USED WITHOUT WRITTEN PERMISSION					
ANGULAR ± 3 °		MATERIAL NO.	WWSCHANG	2005/03/22						
DRAFT WHERE APPLICABLE MUST REMAIN WITHIN DIMENSIONS		SEE TABLE		DOCUMENT NO.	SD-87715-206					

6 5 4 3 2 1

7 6 5 4 3 2 1

E

D

C

B

A

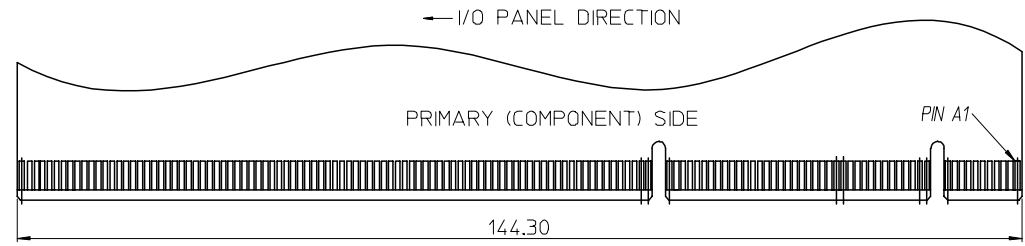
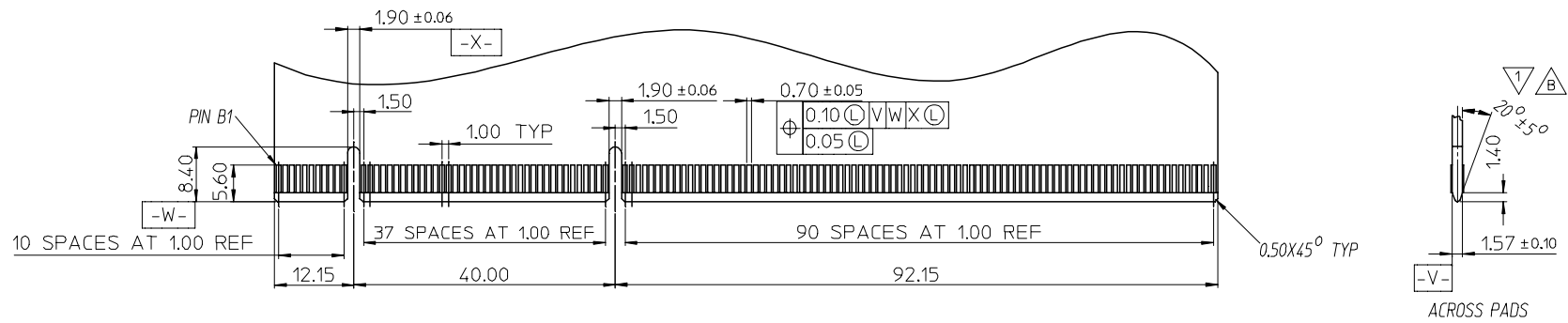

△ I/O PANEL → DIRECTION  
DAUGHTER CARD  
SECONDARY (SOLDER) SIDE

△ CHAMFER EDGES MUST BE FREE OF CUTTING BURRS.

SEE SHEET 1 EC NO: SH2006-0100 DRWN: ALL IN CHKD: APPR: WWSCHANG 2006/05/15 2006/05/15 2006/05/16	QUALITY SYMBOLS	GENERAL TOLERANCES (UNLESS SPECIFIED)		DIMENSION STYLE		SCALE	DESIGN UNITS	THIRD ANGLE PROJECTION	
	▽ = 0 ◻ = 0	mm	INCH	MM ONLY		1:1	METRIC		
		4 PLACES ± ---	± ---	DRAWN BY	DATE	TITLE			
		3 PLACES ± ---	± ---	TOM	2005/03/22	1.0 EDGE CARD 280 CKT VERTICAL DIP CONNECTOR (LEAD FREE VERSION)			
		2 PLACES ± 0.25	± ---	CHECKED BY	DATE	MOLEX INCORPORATED			
	1 PLACE ± 0.25	± ---	ALL IN	2005/03/22					
	ANGULAR ± 3 °	DRAFT WHERE APPLICABLE MUST REMAIN WITHIN DIMENSIONS		APPROVED BY	DATE	DOCUMENT NO.		SHEET NO.	
				WWSCHANG	2005/03/22	SD-87715-206		2 OF 2	
				MATERIAL NO.					
				SEE TABLE					
				SIZE	THIS DRAWING CONTAINS INFORMATION THAT IS PROPRIETARY TO MOLEX INCORPORATED AND SHOULD NOT BE USED WITHOUT WRITTEN PERMISSION				
				4					

ib\_frame\_A4\_P\_AM\_T  
Rev. D 2004/06/28

6 5 4 3 2 1