

Emitter common (dual transistors)

UMW1N / FMW1

●Features

- 1) Two 2SC2412K chips in a UMT or SMT package.
- 2) Mounting cost and area can be cut in half.

●Structure

Epitaxial planar type
NPN silicon transistor

The following characteristics apply to both Tr₁ and Tr₂.

●External dimensions (Units: mm)

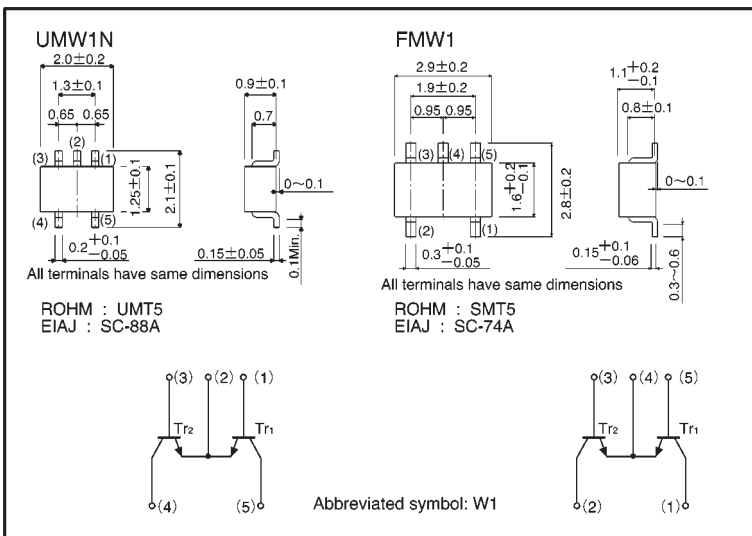

●Absolute maximum ratings (Ta = 25°C)

Parameter	Symbol	Limits	Unit
Collector-base voltage	V _{CB0}	60	V
Collector-emitter voltage	V _{CE0}	50	V
Emitter-base voltage	V _{EB0}	7	V
Collector current	I _c	150	mA
Power dissipation	UMW1N	150 (TOTAL)	mW *1
	FMW1	300 (TOTAL)	
Junction temperature	T _j	150	°C
Storage temperature	T _{stg}	-55 ~ +150	°C

*1 120mW per element must not be exceeded.

*2 200mW per element must not be exceeded.

●Electrical characteristics (Ta = 25°C)

Parameter	Symbol	Min.	Typ.	Max.	Unit	Conditions
Collector-base breakdown voltage	BV_{CBO}	60	—	—	V	$I_C=50\mu A$
Collector-emitter breakdown voltage	BV_{CEO}	50	—	—	V	$I_C=1mA$
Emitter-base breakdown voltage	BV_{EBO}	7	—	—	V	$I_E=50\mu A$
Collector cutoff current	I_{CBO}	—	—	0.1	μA	$V_{CB}=60V$
Emitter cutoff current	I_{EBO}	—	—	0.1	μA	$V_{EB}=7V$
Collector-emitter saturation voltage	$V_{CE(sat)}$	—	—	0.4	V	$I_C/I_B=50mA/5mA$
DC current transfer ratio	h_{FE}	120	—	560	—	$V_{CE}=6V, I_C=1mA$
Transition frequency	f_r	—	180	—	MHz	$V_{CE}=12V, I_E=2mA, f=100MHz$
Output capacitance	C_{ob}	—	2	3.5	pF	$V_{CB}=12V, I_E=0A, f=1MHz$

●Packaging specifications

Part No.	Packaging type	Taping	
	Code	TR	T148
	Basic ordering unit (pieces)	3000	3000
UMW1N		○	—
FMW1		—	○

●Electrical characteristic curves

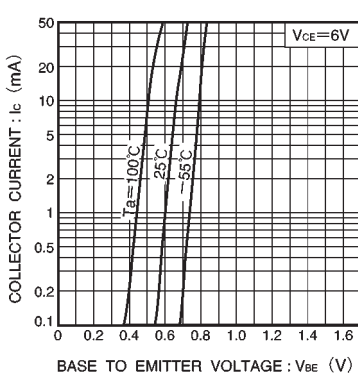

Fig.1 Grounded emitter propagation characteristics

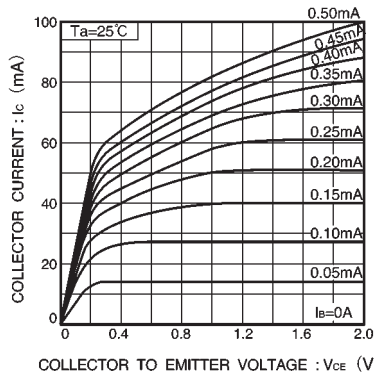

Fig.2 Grounded emitter output characteristics (I)

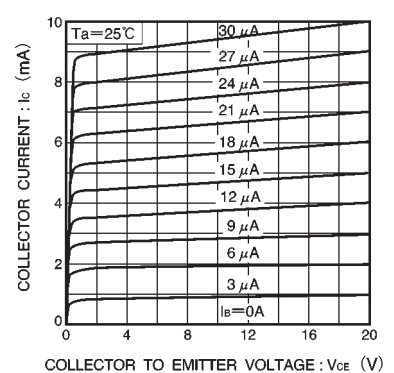

Fig.3 Grounded emitter output characteristics (II)

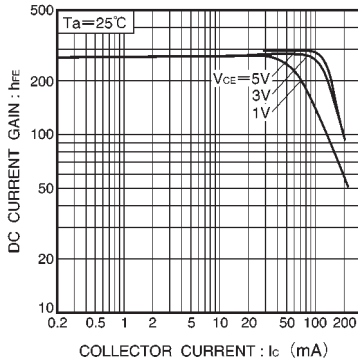

Fig.4 DC current gain vs. collector current (I)

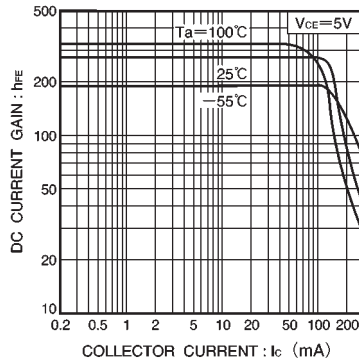

Fig.5 DC current gain vs. collector current (II)

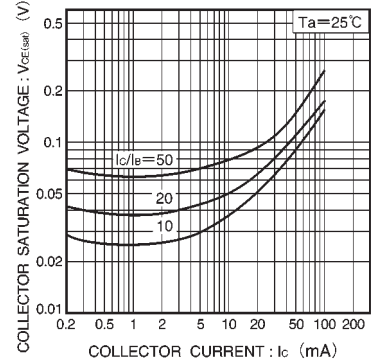

Fig.6 Collector-emitter saturation voltage vs. collector current

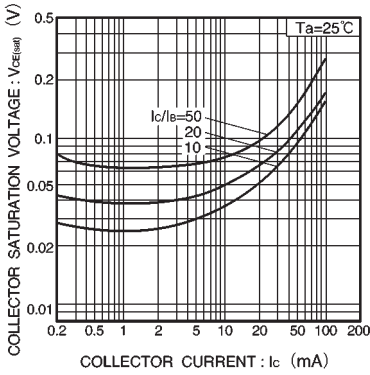

Fig.7 Collector-emitter saturation voltage vs. collector current (I)

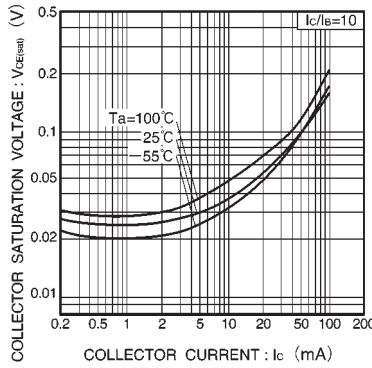

Fig.8 Collector-emitter saturation voltage vs. collector current (II)

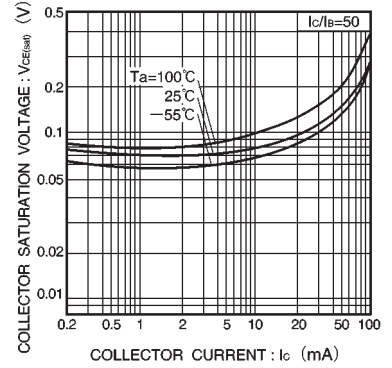

Fig.9 Collector-emitter saturation voltage vs. collector current (III)

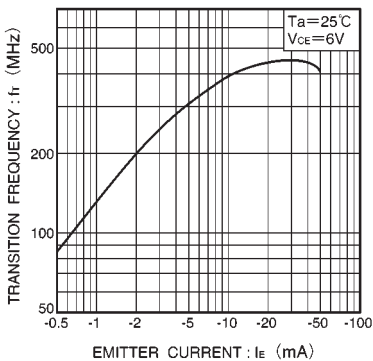

Fig.10 Gain bandwidth product vs. emitter current

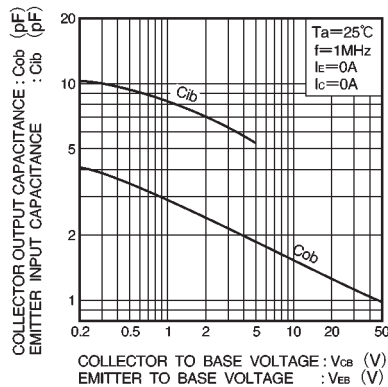

Fig.11 Collector output capacitance vs. collector-base voltage
Emitter input capacitance vs. emitter-base voltage

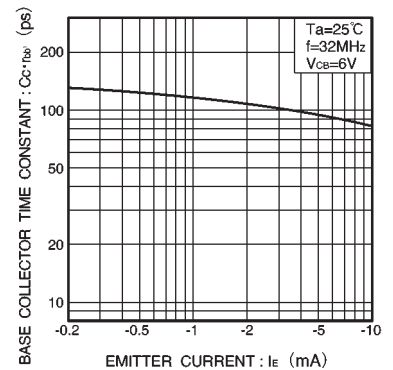

Fig.12 Base-collector time constant vs. emitter current