

4-Pin Red LED Lamp (7.6mm)

OVFSRAC8

- Packaged in tubes
- Compatible with automatic placement equipment
- Compatible with infrared and vapor phase reflow solder process
- Mono-color type
- Pb-free

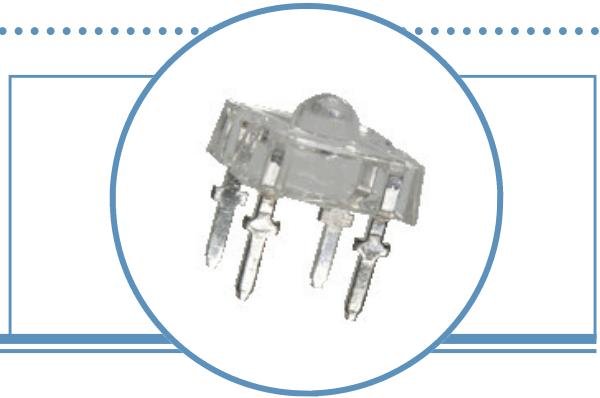

The OVFSRAC8 is designed with higher forward voltage to maximize brightness and incorporates a low-profile lens to enhance efficient light distribution. Response time is fast and it consumes less power resulting in low current requirements from circuit power supply. Tubular arrays replace neon in outdoor and indoor signs. This square package allows high-density arrays to form light engines.

Applications

- Automotive: Rear Stop/Turn Signal Lamps/Truck Marker Lamps
- Mood-setting Decoration and Landscape Lighting
 - Special Decorative Interior/Exterior Lighting
 - Special Effects Stage Lighting
- Illumination for Signs and Channel Letters
- Traffic Signals, Pedestrian and Walkway Signs

Part Number	Material	Emitted Color	Flux Typ. mlm	Lens Color
OVFSRAC8	AllnGaP	Red	4500	Water Clear

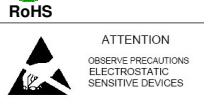
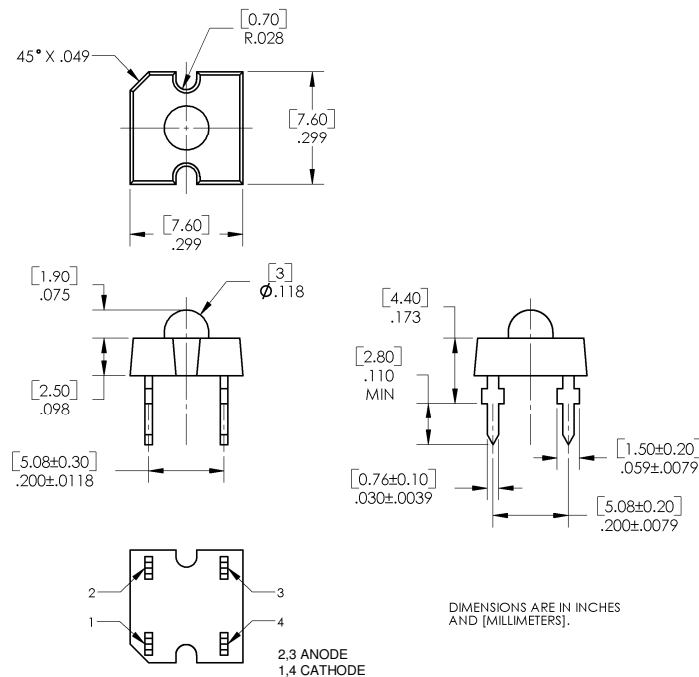

Data is subject to change without prior notice.

4-Pin Red LED Lamp (7.6mm)

OVFSRAC8

Absolute Maximum Ratings

$T_A = 25^\circ\text{C}$ unless otherwise noted

Storage Temperature Range	-40 ~ +100°C
Operating Temperature Range	-40 ~ +100°C
Lead Soldering Temperature (3mm from the base of the epoxy bulb) ¹	260°C
Reverse Voltage	5 V
Continuous Forward Current ²	70 mA
Peak Forward Current (10% Duty Cycle, PW ≤ 100 μsec)	200 mA
Power Dissipation	210 mW

Notes:

- Solder time less than 5 seconds at temperature extreme.
- Heat sink is adequate if the device is operated at ambient temperature higher than 25°C. For long term performance the drive currents between 10mA and 50mA are recommended. Please contact an Optek sales representative for more information on recommended drive conditions.

Electrical Characteristics

$T_A = 25^\circ\text{C}$ unless otherwise noted

SYMBOL	PARAMETER	MIN	TYP	MAX	UNITS	CONDITIONS
lumen	Luminous Flux	3000	4500	----	mlm	$I_F = 70\text{mA}$
V_F	Forward Voltage	----	2.5	3.0	V	$I_F = 70\text{mA}$
I_R	Reverse Current	----	----	100	μA	$V_R = 5\text{V}$
λ_D	Dominant Wavelength	618	624	630	nm	$I_F = 70\text{mA}$
$2\ \Theta_{1/2}$	50% Power Angle	----	100	----	deg	$I_F = 70\text{mA}$

Standard Bins ($I_F = 70\text{mA}$)

Lamps are sorted to luminous flux (Φ_V), forward voltage (V_F), and dominant wavelength (λ_D) bins shown. Orders for OVFSRAC8 may be filled with any or all bins contained as below.

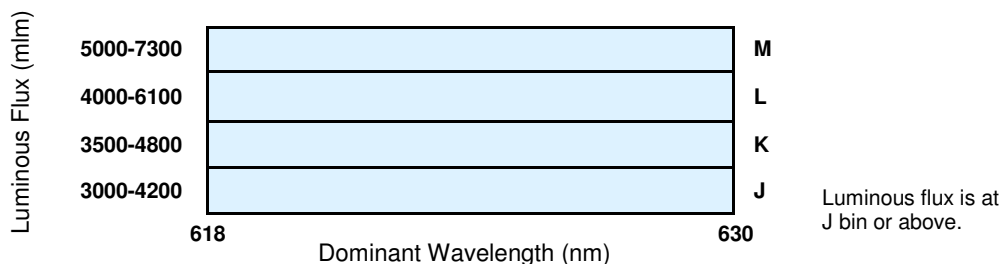

Forward Voltage (V_F)

Rank	V3	V4	V5	V6	V7
Voltage (V)	2.0–2.2	2.2–2.4	2.4–2.6	2.6–2.8	2.8–3.0

Important Notes:

- All ranks will be included per delivery, rank ratio will be based on the chip distribution.
- To designate luminous intensity ranks, please contact OPTEK.

Typical Electro-Optical Characteristics Curves

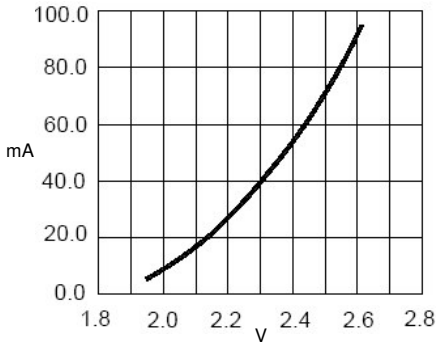

Forward Current vs. Forward Voltage

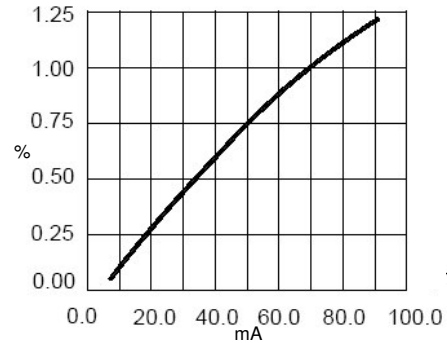

Relative Luminous Flux vs. Forward Current

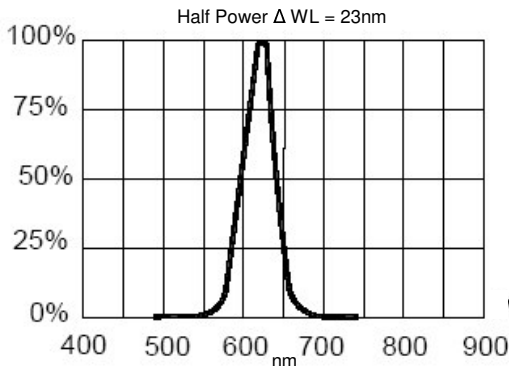

Relative Luminous Flux vs. Wavelength

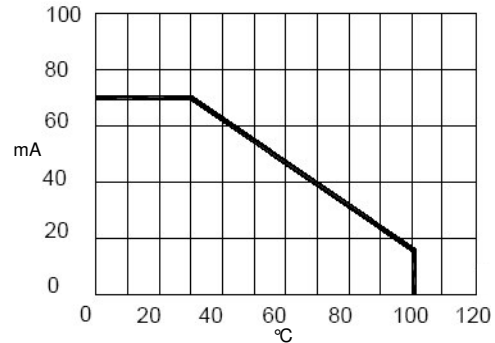

Maximum Forward DC Current vs. Ambient Temperature

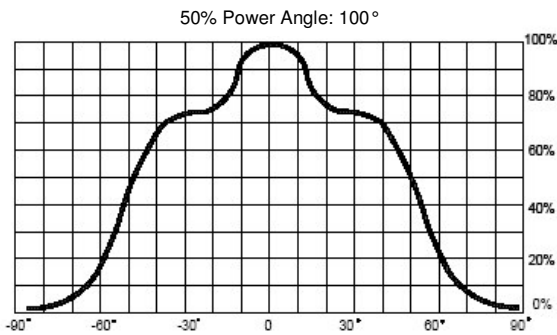

Far Field Pattern

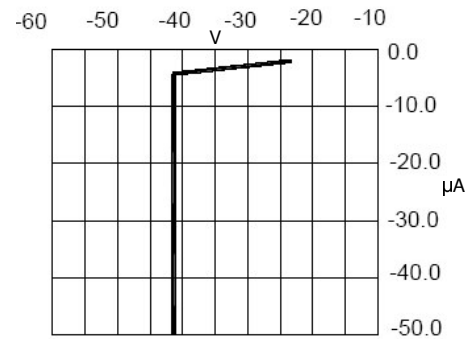

Reverse Current vs. Reverse Voltage

4-Pin Red LED Lamp (7.6mm) OVFSRAC8

Moisture Resistant Packaging

